

**NEW**  
ITEMS ADDED  
PG 108-109

*Genuine*  
**NEWSTAR™**  
2013 FREIGHTLINER CATALOG



**ISO**  
ISO 9001:2008 CERTIFIED

NSFRT-0002 11/2013

# ISO CERTIFICATION ANNOUNCEMENT!



S & S Truck Parts, Inc is proud to announce it is now certified as an ISO 9001:2008 compliant organization. The certification is accredited by Perry Johnson Registrars (PJR).

The certification of compliance with ISO 9001:2008 recognizes that the policies, practices and procedures of our company ensure consistent quality in the product and services we provide our clients. With this certification, our clients can be confident that S and S Truck Parts, Inc is dedicated to maintaining the highest efficiency and responsiveness in achieving our ultimate goal – guaranteed client satisfaction.

## DISCLAIMER

This NEWSTAR Freightliner Catalog provides information on various replacement components offered by S&S Truck Parts, Inc. / NEWSTAR. We have extensively examined the material provided to assure accuracy and reliability. However, this information should only be used to assist the user in identifying the product we are offering as a replacement.

## TRADEMARK ACKNOWLEDGEMENTS

S & S Truck Parts, Inc. / NEWSTAR use of the names of original manufacturers, their models, types, part numbers and other descriptive product information is only for the purpose of aiding customers in cross-referencing to the appropriate S & S / NEWSTAR part. The following is a listing, compiled to the best of our knowledge, of Trademarks used in this catalog for the aforementioned purpose.

APSCO is a BRAND OF AIR POWER SYSTEMS CO., INC.  
BENDIX is a trademark of BENDIX COMMERCIAL VEH. SYSTEMS, LLC.  
BUYERS is a BRAND OF BUYERS PRODUCTS COMPANY  
CHELSEA is a trademark of PARKER HANNIFIN CORP.  
DANA® is a trademark of DANA CORP.  
FEDERAL MOGUL is a trademark of FEDERAL-MOGUL CORP.  
MERITOR is a trademark of MERITOR TECHNOLOGY, INC.

MUNCIE is a trademark of MUNCIE POWER PRODUCTS, INC.  
NEAPCO is a trademark of NEAPCO, INC.  
NEWSTAR is a trademark of S & S TRUCK PARTS, INC.  
PARKER/COMMERCIAL is a trademark of PARKER HANNIFIN CORP.  
PERMCO is a trademark of PERMCO, INC.  
WILLIAMS is a BRAND OF WILLIAMS CONTROLS INDUSTRIES, INC.



BENDIX® and the following alpha-numeric trademarks are owned or licensed by Bendix Commercial Vehicle Systems LLC. They are used within our catalog for reference and informational purposes only.

AD-9™ AD-IP™ AD-IS™ MV-3™

# TABLE OF CONTENTS

## AIR & HYDRAULIC

AIR DRYER ASSEMBLIES AND CARTRIDGES .....	4
AIR GOVERNORS .....	5
SLACK ADJUSTERS AND HUB CAPS .....	6
SWITCHES .....	7
VALVES .....	8-10
MISCELLANEOUS .....	11-12

## BEARINGS

BEARINGS .....	13-14
BEARING AND SEAL KITS .....	15-17
WHEEL BEARING SETS .....	18
WHEEL SEALS .....	19
BEARINGS AND SEALS .....	20-22

## HOOD & BODY PARTS

BUMPERS AND FENDERS .....	23-27
DOORS .....	28-31
GRILLES .....	32-35
HOODS .....	36-37
HOOD ACCESSORIES .....	38-41
LIGHTS, LAMPS, AND FLASHERS .....	42
LIGHTS .....	42-45
MIRRORS .....	46
MISCELLANEOUS .....	47-48

## CAB

SWITCHES .....	49-50
VALVES .....	51
AIR SPRINGS .....	52

<b>CLUTCH</b> .....	53-57
---------------------	-------

## DRIVELINE

CENTER BEARINGS .....	58
KITS .....	59
UNIVERSAL JOINTS .....	60

<b>ELECTRICAL</b> .....	61-62
-------------------------	-------

## ENGINE

FAN CLUTCH, BELTS, AND GASKETS .....	63-65
DETROIT DIESEL ENGINE SENSORS .....	66
MOUNTS .....	67-68
SENSORS, RELAYS, SENDERS, AND SOLENOIDS .....	69-70

<b>EXHAUST</b> .....	71-72
----------------------	-------

## HVAC

BLOWER MOTORS .....	73
COMPRESSORS .....	74
CONDENSORS .....	75-76
EXPANSION VALVES .....	77
RECEIVER DRYERS .....	78
MISCELLANEOUS .....	79-80

<b>RADIATORS, CHARGER AIR COOLERS</b> .....	81-87
---	-------

<b>STEERING</b> .....	88-93
-----------------------	-------

<b>SUSPENSION</b> .....	94-104
-------------------------	--------

<b>TRAILER</b> .....	105-106
----------------------	---------

<b>WIPER ARMS, MOTORS, AND COMPONENTS</b> .....	107
---	-----

# AIR & HYDRAULIC

## AIR DRYER ASSEMBLIES AND CARTRIDGES



**NEWSTAR** No.

**S-F345**

### AIR DRYER ASSEMBLY

#### Replacement for

Freightliner Number: BX 065225

- 12 Volt Complete Replacement Unit
- Includes Bracket Kit - S-16027
- No Core Charges



S-16027



**NEWSTAR** No.

**S-11844**

### AIR DRYER CARTRIDGE

#### Replacement for

Freightliner Number: BX 109493  
BW 065625

- Includes Seal Ring Kit
- New Cartridge - Sold Outrite
- No Core Charges



**NEWSTAR** No.

**S-A323**

### AIR DRYER CARTRIDGE

#### Replacement for

Freightliner Number: BW 109994

- Includes Seal Rings
- New Cartridge - Sold Outrite
- No Core Charges



**NEWSTAR** No.

**S-13728**

### AIR DRYER ASSEMBLY

#### Replacement for

Freightliner Number: TDA R95205

- 12 Volt Complete Replacement Unit
- Includes Pressure Controlled Check Valve
- No Core Charges



# AIR & HYDRAULIC AIR GOVERNORS

## AIR GOVERNOR - STANDARD

### Replacement for

Freightliner Number: BW 275491

- All Ports 1/8" NPT
- Includes 4 Plugs, MTG Gasket
- Governors are pre-set @ 125 PSI

NEWSTAR No.

**S-6106**

## AIR GOVERNOR - HIGH TEMP

### Replacement for

Freightliner Number: BW 284358

- All Ports 1/8" NPT
- Includes 4 Plugs, MTG Gasket
- Governors are pre-set @ 125 PSI

NEWSTAR No.

**S-A535**

## AIR GOVERNOR - NON ADJUSTABLE

### Replacement for

Freightliner Number: BW 800361

- All Ports 1/8" NPT
- Includes 4 Plugs, MTG Gasket
- Governors are Pre-Set @ 130 PSI

NEWSTAR No.

**S-11874**



## AIR GOVERNOR - 12 PACK OF S-6106

### Replacement for

Freightliner Number: BW 275491-12

NEWSTAR No.

**S-F496**



ALL NEWSTAR GOVERNORS, S-6106, S-A535, AND S-11874 HAVE PASSED THE SAE STANDARDS ENDURANCE TEST.

THE SPECIFICATIONS INCLUDE 130 P.S.I. INPUT PRESSURE AND DELIVERY, EXHAUSTED IN A 4 SECOND CYCLE, 200,000 PLUS TIMES.



# AIR & HYDRAULIC SLACK ADJUSTERS AND HUB CAPS

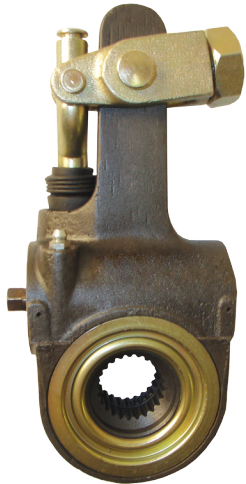

- Most popular 5.5" arms
- Complete with straight clevis (quick-connect)
- Unhanded design fits most brakes
- Drilled worm wheel for lubrication
- Factory lubricated and sealed
- Heavy duty internals
- No external brackets required
- Clearance sensing design
- Automatic adjustment on brake application
- Finest quality ductile nodular iron

Newstar Number	Spline	Drilling	Replacement for Freightliner Number
<b>S-B888</b>	1 1/2" - 10	5 1/2"	GUN AS1132
<b>S-C299</b>	1 1/4" - 10	5 1/2"	GUN AS1136
<b>S-C300</b>	1 1/4" - 24	5 1/2"	GUN AS1138
<b>S-A670</b>	1 1/2" - 28	5 1/2"	TDA R801079

S-B360

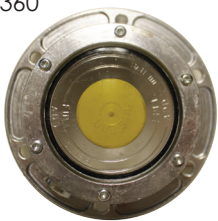

S-B362



S-B358



S-B365



S-E781

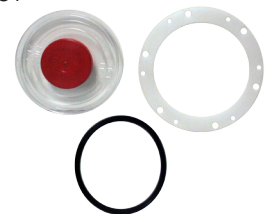

Newstar Number	Replacement for Freightliner Number	Description
<b>S-B360</b>	STM 343-4009	HUB CAP WITH GASKET
<b>S-B362</b>	STM 343-4075	HUB CAP WITH GASKET
<b>S-B358</b>	STM 343-4024	HUB CAP WITH GASKET
<b>S-B365</b>	STM 359-5990	VENT PLUG
<b>S-E781</b>	STM 359-5995	HUB CAP WINDOW KIT



## TOGGLE SWITCH

### Replacement for

Freightliner Number: CTH 8956K895

- FLD

 NEWSTAR<sup>®</sup> No.

**S-20674**



## TOGGLE SWITCH

### Replacement for

Freightliner Number: CTH 8956K897

- FLD

 NEWSTAR<sup>®</sup> No.

**S-20676**



## TOGGLE SWITCH

### Replacement for

Freightliner Number: CTH 8956K913

- FLD

 NEWSTAR<sup>®</sup> No.

**S-20675**



## AIR PRESSURE SWITCH

### Replacement for

Freightliner Number: FSC 1749 1907

- Columbia / Century

 NEWSTAR<sup>®</sup> No.

**S-20677**



## CUT-OFF SWITCH

### Replacement for

Freightliner Number: FSC 1749 2134

- Columbia / Century

 NEWSTAR<sup>®</sup> No.

**S-20678**



# AIR & HYDRAULIC VALVES

NEWSTAR No.

S-F316



## HEIGHT CONTROL VALVE

### Replacement for

Freightliner Number: H600

- Includes Brackets and Fittings

NEWSTAR No.

S-20543

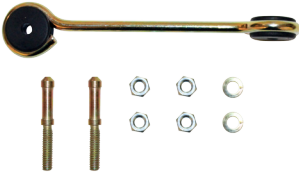

## LINK-LEVELING VALVE

### Replacement for

Freightliner Number: 18-51378-000

- Columbia, FLD and Century
- Fits Barksdale Leveling Valves
- 5.25" Long

NEWSTAR No.

S-16394



## TRACTOR PROTECTION VALVE

### Replacement for

Freightliner Number: BW 065706

- 3/8" NPT Tractor Control (Primary)
- 3/8" NPT Tractor Control (Secondary)
- 1/4" NPT Stop Lite Switch Port
- 1/4" NPT Tractor Support Port
- 1/2" NPT Trailer Control Port
- 1/2" Npt Trailer Support Port

NEWSTAR No.

S-16725

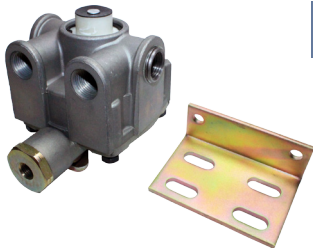

## RELAY VALVE

### Replacement for

Freightliner Number: BW 104574

- 1/2" NPT Supply Ports
- Crack Pressure 4 PSI

NEWSTAR No.

S-18044



## QUICK RELEASE VALVE

### Replacement for

Freightliner Number: BW 800333

- Mounts to Tractor Protection Valve





## PURGE VALVE ASSEMBLY KIT

### Replacement for

Freightliner Number: BW 800405

- Application: AD-9 Dryers
- 12 Volt (w/ white cover)

NEWSTAR<sup>®</sup> No.

S-D810



## PURGE VALVE ASSEMBLY KIT- "OLD" STYLE

### Replacement for

Freightliner Number: BW 800404

- Application: AD-IP and AD-IS Dryers

NEWSTAR<sup>®</sup> No.

S-12093



## PURGE VALVE ASSEMBLY KIT- "NEW" STYLE

### Replacement for

Freightliner Number: BW K022105

- Application: AD-IP and AD-IS Dryers

NEWSTAR<sup>®</sup> No.

S-17760



## DASH CONTROL VALVE

### Replacement for

Freightliner Number: BW 800573

- MV-3 Model-Type 1 Plate w/ 1/4"-20 Mounting Hole Threads

NEWSTAR<sup>®</sup> No.

S-16933



## PURGE VALVE KIT

### Replacement for

Freightliner Number: BW 5005037

- Includes Purge Piston Assy. - Hard Seat
- Fits Bendix AD-9 Air Dryers

NEWSTAR<sup>®</sup> No.

S-A568



Genuine  
**NEWSTAR**<sup>™</sup>

# AIR & HYDRAULIC VALVES



S-C462



S-C461



S-C460

Newstar Number

Replacement for Freightliner Number

Description

S-C462	FUL A-6909	RANGE VALVE
S-C461	FUL A-6913	RANGE VALVE
S-C460	FUL A-6915	RANGE VALVE



NEWSTAR No.

S-5116

## DUAL HORN KIT

Replacement for

Freightliner Number:

GRV 1650

- Universal



NEWSTAR No.

S-C062

## FLIPPER VALVE

Replacement for

Freightliner Number:

GTD 3220 1

- Multiple Freightliner Applications



NEWSTAR No.

S-C065

## FLIPPER VALVE

Replacement for

Freightliner Number:

GTD 3222 1

- Multiple Freightliner Applications



## Can't find what you're looking for?

For a complete listing of our Air & Hydraulic products, please see our Air & Hydraulics Systems catalog or visit the S & S Website at [www.sandstruck.com](http://www.sandstruck.com)

### HORN ASSEMBLY

**Replacement for**

Freightliner Number: GRV 1600

 NEWSTAR No.

**S-13884**



### MV3 DASH REPAIR KIT

**Replacement for**

Freightliner Number: BW 107216

 NEWSTAR No.

**S-C428**



### CLEVIS KIT

**Replacement for**

Freightliner Number: TDA R810019

 NEWSTAR No.

**S-19077**



- 5/8" Threads
- Fits Meritor Automatic Slack Adjusters

### TYPE 30 SPRING BRAKE

**Replacement for**

Freightliner Number: 3030TS

 NEWSTAR No.

**S-16987**



# AIR & HYDRAULIC

## MISCELLANEOUS



 NEWSTAR No.

**S-18633**

### CAM LEVER

#### Replacement for

Freightliner Number: ASL 4150080

- For 2086 Emergency Brake Shoe Assemblies



 NEWSTAR No.

**S-20336**

### BRAKE LEVER

#### Replacement for

Freightliner Number: ASL 4151751

- For 2086 Emergency Brake Shoe Assemblies



 NEWSTAR No.

**S-14094**

### NS750 CYLINDER HEAD GASKET

#### Replacement for

Freightliner Number: BW 298715



 NEWSTAR No.

**S-13394**

### AIR COMPRESSOR

#### Replacement For

Freightliner Number: BW 5004188

- Detroit Diesel Series 60
- Includes 69 Tooth Drive Gear and Safety Valve



 NEWSTAR No.

**S-C333**

### AIR COIL SET

#### Replacement for

Freightliner Number: MID 11952

- Universal



## ALLIANCE FRONT TANDEM AXLE BEARING KIT

 NEWSTAR<sup>®</sup> No.

**S-20325**

**Application:**  
RTXX-4N

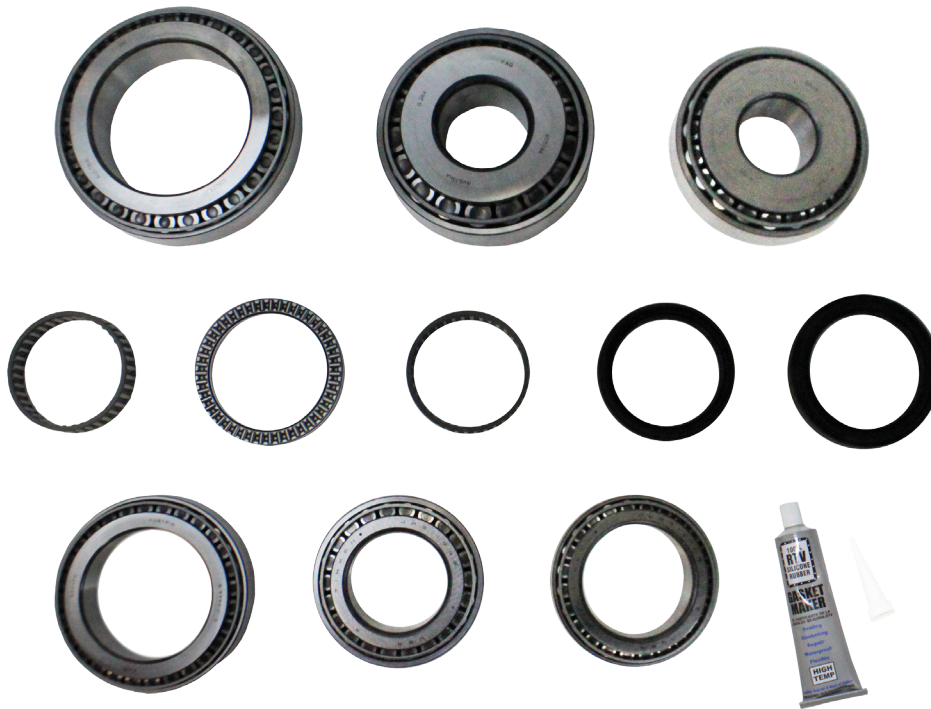

### Includes:

Newstar Number	Replacement for Part Number	Description
S-D995	3920	Bearing Cup
S-20539	32017X	Metric Bearing Set
S-20521	32022X	Metric Bearing Set
S-20327	805096	Pinion Bearing Set
S-20328	805097	Pinion Bearing Set
S-7667	107276	Gasket Maker
S-18134	JLM714149	Bearing
S-18133	JLM714110	Bearing
S-11492	JM511945	Bearing
S-20731	MBA 01-39976-646	Input Seal
S-20732	MBA 01-39976-746	Output Seal
S-20534	-----	Thrust Bearing
S-20532	-----	Caged Needle Bearing

# BEARINGS

## ALLIANCE REAR TANDEM AXLE BEARING KIT

**NEWSTAR<sup>®</sup> No.**

**S-20326**

**Application:**  
RTXX-4N



### Includes:

Newstar Number	Replacement for Part Number	Description
S-20730	MBA 01-39976-246	Pinion Seal
S-20539	32017X	Metric Bearing Set
S-20521	32022X	Metric Bearing Set
S-7667	107276	Gasket Maker
S-20327	805096	Pinion Bearing Set
S-20328	805097	Pinion Bearing Set



**NEWSTAR<sup>®</sup> No.**

**S-20327**

## ALLIANCE INNER PINION BEARING, FRONT AND REAR TANDEM

### Replacement for

Freightliner Number: 805096



**NEWSTAR<sup>®</sup> No.**

**S-20328**

## ALLIANCE OUTER PINION BEARING, FRONT AND REAR TANDEM

### Replacement for

Freightliner Number: 805097



# BEARINGS

## BEARING AND SEAL KITS

Newstar Number	Industry Number	Replacement OEM Number	Application
<b>S-9561</b>	RA172FB	KIT-4080	SSHD STHD SUHD Taper Bearing on Input & Output Shaft
<b>S-9562</b>	RA172R	KIT-4075	SSHP SUHR Early Style Seal
<b>S-9570</b>	RA194F	KIT-4055	SL100/P SQ100/P SQR100/P Front Tandem
<b>S-9568</b>	RA194RA	KIT-4045	SQHP Rear Tandem Small Pinion Design
<b>S-9569</b>	RA194RB	KIT-4065	SL100/P SQ100/P SQR100/P Rear Tandem
<b>S-9578</b>	RA217F	KIT-4395	140/1/3/4/5 Series Tandem Prior to 1993 with Original 39 Spline Input shaft
<b>S-A574</b>	RA217R	KIT-4400	140/1/3/4/5 Single and Rear Tandem
<b>S-9839</b>	RA218	KIT-4340	120/5 Single Axles
<b>S-A575</b>	RA224	KIT-4385	145
<b>S-13136</b>	RA404		RD404/RD405 Rear Differential
<b>S-19137</b>	RA404F		DS404/DA404 Front Differential
<b>S-9562</b>	RA4105	KIT-4105	SSHP SUHR Late Style Seal
<b>s-20835</b>	RA4140	KIT-4140	SR/U/W170/270/280 All Ratios Except 7.40
<b>S-20836</b>	RA4220	KIT-4220	SRTDD SRDD
<b>S-20837</b>	RA4345	KIT-4345	RS16140 R17140 Casting M1547
<b>S-20838</b>	RA4350	KIT-4350	RS16140 R17140 Casting L1676
<b>S-11197</b>	RA4356	KIT-4356	140 After 11/93 with large Input Shaft
<b>S-C545</b>	RA4390	KIT-4390	140/1/3/4/5 Single Rear Cast G1879 and X1558
<b>S-9578</b>	RA4395	KIT-4395	140/1/3/4/5 Front Tandem Prior to 11/93 with 46 Spline Input
<b>S-C546</b>	RA4396	KIT-4396	140/1/3/4/5 Front Tandem After 11/93
<b>S-C547</b>	RA4405	KIT-4405	140/1/3/4/5 Front Tandem After 11/93
<b>S-C548</b>	RA4406	KIT-4406	140/1/3/4/5 Front Tandem Prior 11/93
<b>S-C549</b>	RA4415	KIT-4415	160/1/4 Single Rear Axle
<b>S-F245</b>	RA4420	KIT-4420	160/1/4 Front Tandem Axle
<b>S-17325</b>	RA4422	KIT-4422	160/1/4 Front Tandem Axle
<b>S-C550</b>	RA4423	KIT-4423	RD/P/T/RXX-160,1,4
<b>S-C551</b>	RA4426	KIT-4426	160/1/4 Single Rear Axle
<b>S-C552</b>	RA4428	KIT-4428	RSXX-160,1,4
<b>S-C553</b>	RA4435	KIT-4435	RS 180 Fast Ratio's Under 6.83
<b>S-20839</b>	RA4436	KIT-4436	180/5/6 380 Ratios from 6.83 to 7.83
<b>S-C554</b>	RA4437	KIT-4437	180/5/6 380 Ratios Under 6.83
<b>S-20840</b>	RA4440	KIT-4440	180/5/6 380 All Ratios
<b>S-18592</b>	RA4441	KIT-4441	180/5/6 380 Ratios Under 6.83
<b>S-18593</b>	RA4443	KIT-4443	380 Ratios Under 6.83
<b>S-20841</b>	RA4450	KIT-4450	380 All Ratios
<b>S-9557</b>	RA50	KIT-4150	R/L/S/W170 Prior to 12/1/1983 Exc 7.40
<b>S-20326</b>	RA650		Alliance Axle Rear
<b>S-20325</b>	RA650F		Alliance Axle Front
<b>S-9582</b>	RA900F	KIT-4000	SLHD SQHD 3.55 to 4.63 Front Tandem
<b>S-9706</b>	RA9F	KIT-4025	SLHD, SQHD 1 3/16 Pinion Bearing and Ratios Above 4.63
<b>S-9705</b>	RA9RB	KIT-4010	H120 L100/1/A Ratios Above 4.63
<b>S-9779</b>	RA9RC	KIT-4005	H120 L100/1/A Ratios 3.55 to 4.63
<b>S-F022</b>		216220	RD404/RD405 Rear Differential Overhaul Kit
<b>S-12100</b>		216221	DS404/DA404 Front Differential Overhaul Kit

# BEARINGS

## BEARING AND SEAL KITS

Newstar Number	Replacement OEM Number	Application	Features
S-9836	K-1079	RTO-1258LL W2"PULL	Overhaul
S-9613	K-1554	FULLER AUX. RT.RTO,12513	Rebuild
S-9614	K-1850	FULLER 610.6610	
S-9599	K-1851	FULLER RT.RTO613.6613	Rebuild
S-17177	K-1860	RT1157DLL	Rebuild
S-A573	K-1861	RT/RTO12509,10 RT146,813	Rebuild
S-9601	K-1862	RT12513	Rebuild
S-9602	K-1870	FULLER 14608.609,610	Rebuild
S-9598	K-1871	RT14613,813	Rebuild
S-9608	K-1872	FULLER 14608.615 LL	Rebuild
S-9600	K-1880, K-2283	FULLER 11608.609.613.615.12609.12610	Rebuild
S-19159	K-1971	RT-14608,9 W2" PULL	Overhaul
S-13514	K-1972	RT 14613,813 W/2"PULL	Overhaul
S-20842	K-1995	RT-7608LL W/2" PULL	Overhaul
S-17060	K-1999	RT,O,X14,16709 W/2"PULL	Overhaul
S-9053	K-2043	RTO14708LL, 15715,14915	Rebuild
S-19316	K-2047	RT7608LL	Rebuild
S-17052	K-2275	RT,O,X,14709, 16709	Rebuild
S-0948	K-2277	RT,X 14710, 15710, 16710	Rebuild
S-17061	K-2280	RT14613,14813,15613,15813 W/TAPERED BEARING	Rebuild
S-0750	K-2284	RT,O,11708,9,15,12709 RT,X 13709	Rebuild
S-11446	K-2286	RTLO14713A	Rebuild
S-11447	K-2287	RTLO16713A	Rebuild
S-17053	K-2288	RTLO14718, 16718B	Rebuild
S-11837	K-2336	RTX14710B W/2"PULL	Overhaul
S-17054	K-2758	RTLO14713A W/2"PULL	Overhaul
S-17055	K-2760	RT9508,909,9509 W2" PULL	Overhaul
S-17056	K-2761	RT11608,9 12609 W/2"PULL	Overhaul
S-20843	K-2762	RT13709H W/2"PULL	Overhaul
S-20844	K-2763	RTO,X12709,13710B,C RTO11708LL W/2"PULL	Overhaul
S-20804	K-2765	RTLO 14,15,16,17,18610B W/2"PULL	Overhaul
S-F489	K-2773	RTLO14610B,15610B.16610B.17610B,	Rebuild
S-17057	K-2779	RTLO14718B W/2"PULL	Overhaul
S-9596	K-2780	T-955LL,9508,909,10,958LL,913,5,9513	Rebuild
S-11448	K-2865	RTLO18718B	Rebuild
S-18444	K-2866	RTLO18718B W2"PULL	Overhaul
S-11449	K-2924	FR,O 9,11,12,13,14,15,16,17,18210 Electronic	Rebuild
S-20845	K-2993	RTLO14613/18B W/2"PULL	Overhaul
S-20846	K-2994	RTO15618 W/2" PULL	Overhaul
S-15477	K-3132	FR,O 9,11,12,13,14,15,16,17,18210 Mechanical	Rebuild
S-17059	K-3233	RTO16915	Rebuild
S-17058	K-3234	RTO16915 2" PULL CLUTCH	Overhaul
S-18259	K-3256	RTO11908LL,14908LL RT,O14915	Rebuild
S-19629	K-3273	RT8908LL	Rebuild
S-16913	K-3282	RTO11,14909MLL WITH 2" PULL	Overhaul
S-18395	K-3283	RTO11,14909MLL	Rebuild
S-12099	K-3286	RTLO18913A/-T2	Rebuild





# BEARINGS

## BEARING AND SEAL KITS

Newstar Number	Replacement OEM Number	Application	Features
<b>S-17271</b>	K-3287	RTLO18913A/-T2 W/2" PULL	Overhaul
<b>S-17612</b>	K-3323	RT8709B W/2" PULL	Overhaul
<b>S-17696</b>	K-3339	RTLO20918B/T2 W/2"PULL	Overhaul
<b>S-13017</b>	K-3340	RTLO20918B	Rebuild
<b>S-16576</b>	K-3342	RTO16913A W2"PULL	Overhaul
<b>S-11450</b>	K-3343	RTLO16913A	Rebuild
<b>S-20847</b>	K-3345	RTLO16713A W/2"PULL	Overhaul
<b>S-15365</b>	K-3346	RTLO16713A	Rebuild
<b>S-20848</b>	K-3347	RTLO14913A W/2"PULL	Overhaul
<b>S-20849</b>	K-3354	RTLO14918B W/2" PULL	Overhaul
<b>S-17968</b>	K-3355	RTLO14918B	Rebuild
<b>S-17592</b>	K-3425	RTLO18913A/-T2 W/2"PULL	Overhaul
<b>S-18264</b>	K-3426	RTLO18913A/-T2 W/2" PULL	Overhaul
<b>S-20850</b>	K-3459	RTLO20913A W/2" PULL	Overhaul
<b>S-20851</b>	K-3461	RTLO22918B W/2"PULL	Overhaul
<b>S-17317</b>	K-3522	RTO16910B,AS2	Rebuild
<b>S-17263</b>	K-3660	RTX11715,11708LL	Rebuild
<b>S-17702</b>	KIT-5356	RM9,10-115,125	Rebuild
<b>S-17355</b>	KIT-5357	RM9,10-135,145,165	Rebuild
<b>S-20852</b>	KIT-5358	RM10-135/145/155	Overhaul
<b>S-20853</b>	KIT-5360	RM13	Overhaul
<b>S-16966</b>	KIT-5406	G Platform	Rebuild

# BEARINGS

## WHEEL BEARING SETS

Newstar Number	Industry Number	Consists of	Bore	OD	Width	Features
S-13216	SET 401	580/572	3.2500	5.5115	1.4375	Cup and Cone
S-15370	SET 402	572/582	3.2500	5.5115	1.4375	Cup and Cone
S-13217	SET 403	594A/592A	3.7500	6.0000	1.5625	Cup and Cone
S-15371	SET 404	592A/598A	3.6250	6.0000	1.5625	Cup and Cone
S-15372	SET 405	653/663	3.2500	6.0000	1.6250	Cup and Cone
S-13218	SET 406	3782/3720	1.7500	3.7500	1.1875	Cup and Cone
S-16170	SET 407	28622/28682	2.2500	3.8437	0.9688	Cup and Cone
S-16171	SET 408	39520/39590	2.6250	4.4375	1.1875	Cup and Cone
S-15375	SET 411	47620/47686	3.2500	5.2500	1.3125	Cup and Cone
S-15376	SET 412	HM212011/HM212047	2.5000	4.8125	1.5000	Cup and Cone
S-13219	SET 413	HM212049/HM212011	2.6250	4.8125	1.5000	Cup and Cone
S-13220	SET 414	HM218248/HM218210	3.5423	5.7864	1.5748	Cup and Cone
S-15377	SET 415	HM518410/HM518445	3.5000	6.0000	1.5625	Cup and Cone
S-15378	SET 417	47820/47890	3.6250	5.7500	1.1325	Cup and Cone
S-15379	SET 418	H715311/H715334	2.4375	5.3750	1.8125	Cup and Cone
S-15380	SET 419	H715311/H715343	2.6875	5.3750	1.8125	Cup and Cone
S-16550	SET 420	H715311/H715345	2.8125	5.3750	1.8125	Cup and Cone
S-20410	SET 423	6461A/6420	3.0000	5.8750	2.1350	Cup and Cone
S-18518	SET 424	555S/552A	2.2500	4.8750	1.5000	Cup and Cone



S-15375



S-20410

Newstar Number	Replacement for Freightliner Number	Description	Special Features
S-19817	11-14418-000	Gasket, Axle Stop	7" Bolt Hole Circle Diameter
S-19630	SP 071HG100	Gasket, Front Hub	Dana Eaton 150/160/175/180 Axles
S-14654	TDA KIT 1432	Retro Hub Kit	Hub Kit Assembly with Long Studs, 91MM

S-19817

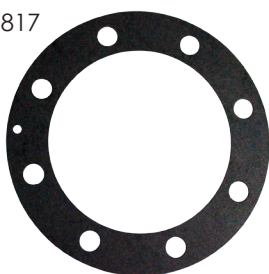

S-19630



S-14654



Newstar Number	Industry Number	Bore	OD	Width
----------------	-----------------	------	----	-------

### Premium- No Tools

S-A225	370001A	3.500"	4.485"	.903"
S-A226	370003A	4.766"	6.316"	1.125"
S-A230	370022A	4.500"	5.756"	1.016"
S-A231	370023A	3.875"	5.696"	0.938"
S-A232	370025A	4.625"	6.006"	1.063"
S-A233	370031A	4.250"	6.259"	1.250"
S-A234	370036A	4.000"	5.767"	0.995"
S-A236	370048A	4.375"	5.918"	1.000"
S-A237	370065A	4.250"	6.025"	.971"
S-A239	370131A	4.500"	5.881"	.984"
S-A240	370033A	4.000"	5.131"	1.047"

### Standard- Tools Required

S-18137	370001A	3.500"	4.485"	.903"
S-18138	370003A	4.766"	6.316"	1.125"
S-18139	370022A	4.500"	5.756"	1.016"
S-18140	370023A	3.875"	5.696"	0.938"
S-18141	370025A	4.625"	6.006"	1.063"
S-18142	370031A	4.250"	6.259"	1.250"
S-18143	370036A	4.000"	5.767"	0.995"
S-18144	370048A	4.375"	5.918"	1.000"



# BEARINGS

## BEARINGS AND SEALS

Newstar Number	OEM Number	Description	Application
<b>S-18153</b>	204	Aux Range Quill Front Ball	RT12513, 14613/813
<b>S-A043</b>	493	Carrier Cup	SLHD / SQHD, RS/DS 404
<b>S-18410</b>	496	Carrier Cone	SLHD / SQHD
<b>S-A044</b>	497	Carrier Cone	SLHD / SQHD, RS/DS 404
<b>S-A045</b>	563	Carrier Cup	RS/DS 404
<b>S-A046</b>	567	Carrier Cone	RS/DS 404
<b>S-C525</b>	3720	Aux Countershaft Rear Cup	RM, O, G Platform
<b>S-C526</b>	3782	Aux Countershaft Rear Cone	RM, O, G Platform
<b>S-D995</b>	3920	Input Shaft Cup	RD 140/1/3/4/5, RT440-4F
<b>S-18997</b>	9220	Pinion Cone	RS 160/1/4, RR 164
<b>S-18998</b>	9278	Pinion Cone	RS 160/1/4, RR 164
<b>S-F450</b>	14287	Rev Idler Roller	All Models
<b>S-C024</b>	21355	Aux Mainshaft Taper Set	8,9 Speeds
<b>S-C025</b>	21356	Aux Mainshaft Taper Set	8,9,10,13,15,18 Speed
<b>S-A047</b>	29630	Drive Gear Cup	SLHD / SQHD, DS 404
<b>S-A048</b>	29675	Drive Gear Cone	SLHD / SQHD, DS 404
<b>S-10459</b>	31520	Idler Gear Cup	SLHD / SQHD
<b>S-A049</b>	31597	Idler Gear Cone	SLHD / SQHD
<b>S-A050</b>	47820	Carrier Cup	SLHD / SQHD, SSHD/STHD/SUHD
<b>S-A051</b>	47890	Carrier Cone	SLHD / SQHD, SSHD/STHD/SUHD
<b>S-15332</b>	52400	Pinion Cup	RP/RD 166, RR 164
<b>S-18129</b>	52618	Pinion Cone	RP/RD 167, RR 164
<b>S-A053</b>	55437	Pinion Cup	RS 144/5, RS/DS 404
<b>S-6654</b>	72487	Pinion Cup	SLHD / SQHD, RS 140/1/3/4/5, RS/DS 404
<b>S-F028</b>	127545	D Ring	DS 404
<b>S-B140</b>	127591	Input Seal	RS/DS 404
<b>S-B141</b>	127592	Output Seal	DS 404
<b>S-7205</b>	415009	Pinion Seal	SLHD / SQHD
<b>S-8604</b>	415146	Oil Seal	RT12513
<b>S-20327</b>	805096	Pinion Bearing Set	RT440-4F, RT440-4R
<b>S-20328</b>	805097	Pinion Bearing Set	RT440-4F, RT440-4R
<b>S-C026</b>	4300828	Aux Countershaft Front Roller	RT12513
<b>S-C027</b>	4300902	Splitter Gear Taper Set	RTLO14718B, RTLO16718B
<b>S-13750</b>	4301855	Input Shaft Bearing Roller	7608LL
<b>S-C029</b>	4302074	Front And Rear Aux Cntr Taper Set	8,9,10,13,15,18 Speed
<b>S-19859</b>	4303031	Countershaft Rear Roller	10,13,18 Speed
<b>S-C031</b>	4304080	Countershaft Rear Roller	RTLO18718B
<b>S-18573</b>	4304599	Countershaft Front Roller	8,9,10,13,15,18 Speed
<b>S-10233</b>	5566507	Aux Drive Gear Bearing Ball	8,9,10 Speed
<b>S-19649</b>	5566508	Aux Drive Gear Bearing Ball	13.18 Speed
<b>S-F531</b>	5566510	Aux Drive Gear Bearing Ball	RTLO20918B
<b>S-A001</b>	118L	Aux Drive Gear Bearing Ball	14608, 14609, 14610
<b>S-17595</b>	119L	Aux Drive Gear Bearing Ball	RM, O, G Platform
<b>S-A018</b>	1212SLV	Input Shaft Bearing Ball	8,9,10,13,15,18 Speed
<b>S-A020</b>	1310L	Aux Countershaft Rear Ball	7608LL



# BEARINGS

## BEARINGS AND SEALS

Newstar Number	OEM Number	Description	Application
<b>S-C034</b>	1310SLV	Aux Countershaft Rear Ball	14613/813
<b>S-13221</b>	1311L	Aux Countershaft Rear Ball	14608, 14609, 14610
<b>S-A004</b>	211B	Input Bearing Ball	SLHD / SQHD
<b>S-20539</b>	32017X	Carrier Bearing Set	RT440-4F, RT440-4R
<b>S-20521</b>	32022X	Carrier Bearing Set	RT440-4F, RT440-4R
<b>S-7199</b>	35949N	Input Seal	SLHD / SQHD
<b>S-4710</b>	405-367-C	Output Seal	SLHD / SQHD, SSHD/STHD/SUHD
<b>S-A052</b>	55200C	Pinion Cone	RS 404
<b>S-18130</b>	55206C	Pinion Cone	RS 144/5
<b>S-11512</b>	55212C	Pinion Cone	DS 404
<b>S-16461</b>	552A	Input Cup	DS 404
<b>S-13793</b>	555S	Input Cone	DS 404
<b>S-A305</b>	592A	Carrier Cup	RP/RD 165, RR 164
<b>S-A306</b>	594A	Carrier Cone	RP/RD 164, RR 164
<b>S-A054</b>	72200C	Pinion Cone	SLHD / SQHD
<b>S-A055</b>	72212C	Pinion Cone	SQHP, SQ100, RS 404
<b>S-A650</b>	72218C	Pinion Cone	DS 404
<b>S-A056</b>	72225C	Pinion Cone	RS 140/1/3/4/5
<b>S-A720</b>	A-1205-G-2425	Output Seal	SQHP, SQ100
<b>S-B435</b>	A-1205-N-2588	Pinion Seal	RS 144/5
<b>S-E014</b>	A-1205-P-1914	Pinion Seal	SSHP/SUHR
<b>S-A630</b>	A-1205-P-2590	Input Seal	SQHP, SQ100, RD 140/1/3/4/5
<b>S-A941</b>	A-1205-Q-2591	Pinion Seal	RS 160/1/4, RD 160/1/6
<b>S-A942</b>	A-1205-R-2592	Pinion Seal	SSHD/STHD/SUHD, RD 140/1/3/4/5
<b>S-16394</b>	A-1205-Y-1897	Pinion Seal	RS 140/1/3/4/5
<b>S-E918</b>	A2892	Aux Mainshaft Taper Set	RT12513
<b>S-20739</b>	A3071	Aux Mainshaft Taper Set	11608/9/13/15, 12609/10, 7608LL
<b>S-A074</b>	H715311	Pinion Cup	SSHP/SUHR, SSHD/STHD/SUHD, RS 140/1/3/4/5
<b>S-A075</b>	H715334	Pinion Cone	SSHP/SUHR, RS 140/1/3/4/5
<b>S-A076</b>	H715343	Pinion Cone	SSHP/SUHR, SSHD/STHD/SUHD
<b>S-E002</b>	HM813810	Pinion Cup	RS 160/1/4, RD 160/1/5
<b>S-E003</b>	HM813843	Pinion Cone	RS 160/1/4, RD 160/1/4
<b>S-A062</b>	JLM104910	Output Cup	SSHD/STHD/SUHD, RD 140/1/3/4/5
<b>S-A063</b>	JLM104949	Output Cone	SSHD/STHD/SUHD, RD 140/1/3/4/5
<b>S-A072</b>	JLM710910	Drive Gear Cup	SQHP, SQ100, RD 140/1/3/4/5
<b>S-A073</b>	JLM710949C	Drive Gear Cone	SQHP, SQ100, RD 140/1/3/4/5
<b>S-18133</b>	JLM714110	Inter-Diff Cup	SSHD/STHD/SUHD, RT440-4F
<b>S-18134</b>	JLM714149	Inter-Diff Cone	SSHD/STHD/SUHD, RT440-4F
<b>S-A068</b>	JM511910	Input Shaft Cup	SQHP, SQ100
<b>S-11492</b>	JM511945	Input Shaft Cone	RD 140/1/3/4/5, RT440-4F
<b>S-A069</b>	JM511946	Input Shaft Cone	SQHP, SQ100, RD 140/1/3/4/5

# BEARINGS

## BEARINGS AND SEALS

Newstar Number	OEM Number	Description	Application
<b>S-A077</b>	JM716610	Carrier Cup	RS 140/1/3/4/5, SQHP, SQ100, RS, RD 140/1/3/4/5
<b>S-A078</b>	JM716649	Carrier Cone	RS 140/1/3/4/5, SQHP, SQ100, RS, RD 140/1/3/4/5
<b>S-17679</b>	JP10010A	Carrier Cup Left	RS 140/1/3/4/5
<b>S-16045</b>	JP10049	Carrier Cone Left	RS 140/1/3/4/5
<b>S-7663</b>	K-2256	Oil Seal Kit	6 & 8 Series
<b>S-8474</b>	K-2262	Oil Seal Kit	7 & 9 Series
<b>S-13443</b>	LM603011	Idler Gear Cup	SQHP, SQ100
<b>S-A071</b>	LM603049	Idler Gear Cone	SQHP, SQ100
<b>S-A024</b>	MR1307EL	Aux Countershaft Front Roller	14608, 14609, 14610, 14615
<b>S-A023</b>	MSN1211REX	Countershaft Front Roller	RT12513
<b>S-A028</b>	MU1308UM	Pilot Bearing	SSHP/SUHR
<b>S-19805</b>	MUB1307UM	Pilot Bearing	DS 404
<b>S-13489</b>	MUB7307UM	Pilot Bearing	RS 404
<b>S-A031</b>	RU1570UM	Pilot Bearing	SLHD / SQHD, SQHP, SQ100
<b>S-C632</b>	RU9008UM	Pilot Bearing	RR 164
<b>S-16980</b>	TDA A1-1205Y-2729	Oil Seal	
<b>S-A038</b>	WJ162116	Rev Idler	7608LL

### Can't find what you're looking for?

For a complete listing of our Drive Train components, including Gear Sets, IAD Kits, Synchros, and Input Shafts, please visit Differential Parts & Transmission Parts on the S & S Website at [www.sandstruck.com](http://www.sandstruck.com)



# HOOD & BODY PARTS

## BUMPERS AND FENDERS

### 3 PIECE BUMPER, LEFT

 NEWSTAR<sup>®</sup> No.

**S-18986**

**Replacement for**  
Freightliner Number:  
21-20112-000

- FLD



S-18986

### 3 PIECE BUMPER, RIGHT

 NEWSTAR<sup>®</sup> No.

**S-18985**

**Replacement for**  
Freightliner Number:  
21-20112-001

- FLD



S-18985

### 3 PIECE BUMPER, CENTER

 NEWSTAR<sup>®</sup> No.

**S-18987**

**Replacement for**  
Freightliner Number:  
21-20113-003

- FLD



S-18987

### BUMPER, STEEL, CENTER

 NEWSTAR<sup>®</sup> No.

**S-20386**

**Replacement for**  
Freightliner Number:  
21-26020-006  
21-26020-011

- Columbia
- Replaces both late and older Columbia



Genuine  
 NEWSTAR<sup>™</sup>

# HOOD & BODY PARTS

## BUMPERS AND FENDERS

S-19813



 NEWSTAR<sup>®</sup> No.

### BUMPER END CAP, PLASTIC, LEFT

**S-19813**

**Replacement for**

Freightliner Number:  
21-26021-004  
21-26021-006

- Columbia

S-19814



 NEWSTAR<sup>®</sup> No.

### BUMPER END CAP, PLASTIC, RIGHT

**S-19814**

**Replacement for**

Freightliner Number:  
21-26021-005  
21-26021-007

- Columbia

\* Bumper Support Information can be found on page 27

S-20154

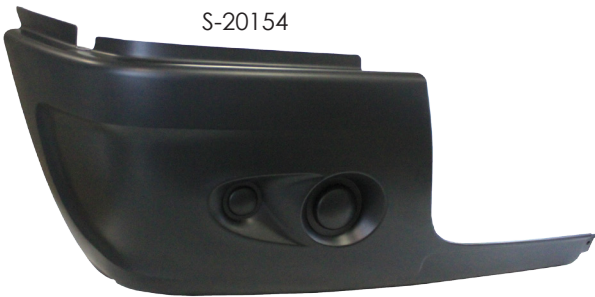

 NEWSTAR<sup>®</sup> No.

### BUMPER, LEFT

**S-20154**

**Replacement for**

Freightliner Number:  
21-26684-000

- Century

S-20155



 NEWSTAR<sup>®</sup> No.

### BUMPER, RIGHT

**S-20155**

**Replacement for**

Freightliner Number:  
21-26684-001

- Century





# HOOD & BODY PARTS

## BUMPERS AND FENDERS

### BUMPER, PAINTED, CENTER

 NEWSTAR<sup>®</sup> No.

**S-20359**

**Replacement for**

Freightliner Number:  
21-28177-001

- Century



### BUMPER, CHROME, CENTER

 NEWSTAR<sup>®</sup> No.

**S-20358**

**Replacement for**

Freightliner Number:  
21-28177-001C

- Century



### BUMPER END (FIBERGLASS)

 NEWSTAR<sup>®</sup> No.

**S-20350**

#### LEFT

**Replacement for**

Freightliner Number:  
21-26517-000F  
21-26517-000

- M2



### BUMPER END (FIBERGLASS)

 NEWSTAR<sup>®</sup> No.

**S-20349**

#### RIGHT

**Replacement for**

Freightliner Number:  
21-26517-001F  
21-26517-001

- M2



Genuine  
 NEWSTAR<sup>™</sup>

# HOOD & BODY PARTS

## BUMPERS AND FENDERS

S-18647



**NEWSTAR** No.

### FENDER EXTENSION, LEFT

**S-18647**

**Replacement for**

Freightliner Number:  
22-37670-000

- FLD

S-18648



**NEWSTAR** No.

### FENDER EXTENSION, RIGHT

**S-18648**

**Replacement for**

Freightliner Number:  
22-37670-001

- FLD

S-19233



**NEWSTAR** No.

### FENDER EXTENSION, LEFT

**S-19233**

**Replacement for**

Freightliner Number:  
A 680 881 0001

- FL60 / 70 / 80

S-19234



**NEWSTAR** No.

### FENDER EXTENSION, RIGHT

**S-19234**

**Replacement for**

Freightliner Number:  
A 680 881 0101

- FL60 / 70 / 80



# HOOD & BODY PARTS

## BUMPERS AND FENDERS

### BUMPER END, RIGHT

NEWSTAR<sup>™</sup> No.

**Replacement for**  
Freightliner Number:  
A21-26500-040

**S-19562**

- M2



### BUMPER SUPPORT, LEFT

NEWSTAR<sup>™</sup> No.

**Replacement for**  
Freightliner Number:  
A22-54198-000

**S-20404**

- Columbia
- Supports S-19813  
(Replacement for 21-26021-004)



S-20404

### BUMPER SUPPORT, RIGHT

NEWSTAR<sup>™</sup> No.

**Replacement for**  
Freightliner Number:  
A22-54198-001

**S-20405**

- Columbia
- Supports S-19814  
(Replacement for 21-26021-005)



S-20405

### FENDER EXTENSION, LEFT

NEWSTAR<sup>™</sup> No.

**Replacement for**  
Freightliner Number:  
A22-57423-000

**S-18504**

- Century / Columbia



S-18504

### FENDER EXTENSION, RIGHT

NEWSTAR<sup>™</sup> No.

**Replacement for**  
Freightliner Number:  
A22-57423-001

**S-18505**

- Century / Columbia

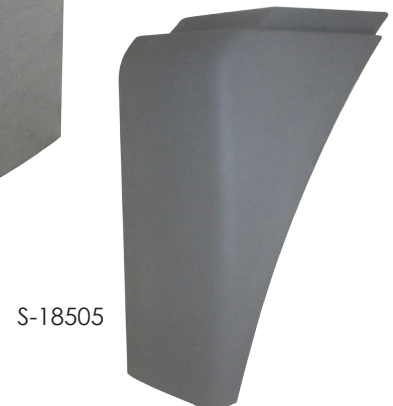

S-18505

Genuine  
**NEWSTAR<sup>™</sup>**

# HOOD & BODY PARTS

## DOORS



S-19549



S-19550

**NEWSTAR** No.

### DOOR, LEFT

**S-19549**

**Replacement for**

Freightliner Number:  
Z18-48818-000

- M2

**NEWSTAR** No.

### DOOR, RIGHT

**S-19550**

**Replacement for**

Freightliner Number:  
Z18-48818-020

- M2

S-18815



S-18816



S-18817



S-18818



S-19117



S-19118



Newstar  
Number

Replacement for  
Freightliner  
Number

Description

Application

<b>S-18815</b>	A18-35381-000	Door Handle, Outside LH	FLD, Early Columbia, Early Century
<b>S-18816</b>	A18-35381-001	Door Handle, Outside RH	FLD, Early Columbia, Early Century
<b>S-18817</b>	A18-42228-000	Door Handle, Outside LH	Century / Columbia
<b>S-18818</b>	A18-42228-001	Door Handle, Outside RH	Century / Columbia
<b>S-19117</b>	A18-42228-002	Door Handle, Outside LH	Later Columbia / Later Century
<b>S-19118</b>	A18-42228-003	Door Handle, Outside RH	Later Columbia / Later Century



# HOOD & BODY PARTS

## DOORS

### HANDLE, PADDLE INNER

**Replacement for**

Freightliner Number: 18-48225-000

- Columbia and Century

NEWSTAR<sup>®</sup> No.

**S-20643**



### HANDLE, PADDLE INNER

**Replacement for**

Freightliner Number: 18-48225-001

- Columbia and Century

NEWSTAR<sup>®</sup> No.

**S-20644**



### WINDOW CRANK

**Replacement for**

Freightliner Number: A18-18557-002

- FLD

NEWSTAR<sup>®</sup> No.

**S-18895**



### KEY DOOR - IGNITION

**Replacement for**

Freightliner Number: 22-54495-000

- All FRT Models 2000 and Up

NEWSTAR<sup>®</sup> No.

**S-20713**

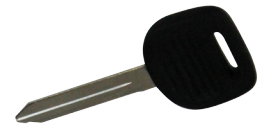

### CYLINDER

**Replacement for**

Freightliner Number: A22-63159-041

- Ignition Cylinder.
- Most Freightliner Trucks

NEWSTAR<sup>®</sup> No.

**S-20856**



### DOOR LATCH

**Replacement for**

Freightliner Number:  
A18-27783-000

- Columbia, FLD, Century

NEWSTAR<sup>®</sup> No.

**S-18808**



S-18808

### DOOR LATCH

**Replacement for**

Freightliner Number:  
A18-27783-001

- Columbia, FLD, Century

NEWSTAR<sup>®</sup> No.

**S-18809**

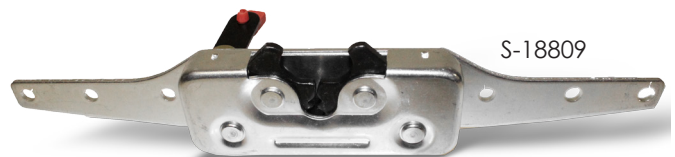

S-18809

Genuine  
**NEWSTAR<sup>™</sup>**

# HOOD & BODY PARTS

## DOORS

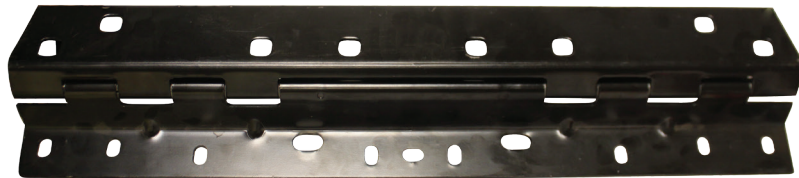

NEWSTAR<sup>®</sup> No.

**S-20668**

### DOOR HINGE ASSEMBLY

**Replacement for**  
Freightliner Number:  
A18-53290-000

- Century and Columbia

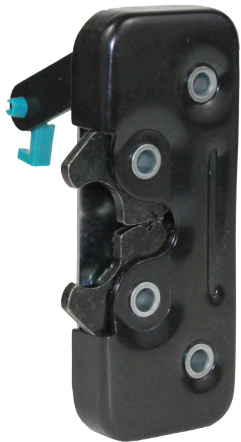

S-19838



S-19839

NEWSTAR<sup>®</sup> No.

**S-19838**

### DOOR LATCH, UPPER LEFT

**Replacement for**  
Freightliner Number:  
A18-43367-000

- Columbia, FLD, Century

NEWSTAR<sup>®</sup> No.

**S-19839**

### DOOR LATCH, UPPER RIGHT

**Replacement for**  
Freightliner Number:  
A18-43367-001

- Columbia, FLD, Century



S-19912



S-18814

NEWSTAR<sup>®</sup> No.

**S-19912**

### DOOR SEAL

**Replacement for**  
Freightliner Number:  
A18-44466-000

- Century and Columbia

NEWSTAR<sup>®</sup> No.

**S-18814**

### WEATHERSTRIP

**Replacement for**  
Freightliner Number:  
A 680 697 00 98

- FL (Medium Duty)



### WINDOW REGULATOR, LEFT HAND

**Replacement for**

Freightliner Number: A18-52044-000

- Century and Columbia

 NEWSTAR<sup>™</sup> No.

**S-20667**



### WINDOW REGULATOR, RIGHT HAND

**Replacement for**

Freightliner Number: A18-52044-001

- Century and Columbia

 NEWSTAR<sup>™</sup> No.

**S-20881**



### WINDOW SWITCH

**Replacement for**

Freightliner Number: A06-30769-008

- Columbia and Century

 NEWSTAR<sup>™</sup> No.

**S-20778**



# HOOD & BODY PARTS

## GRILLES

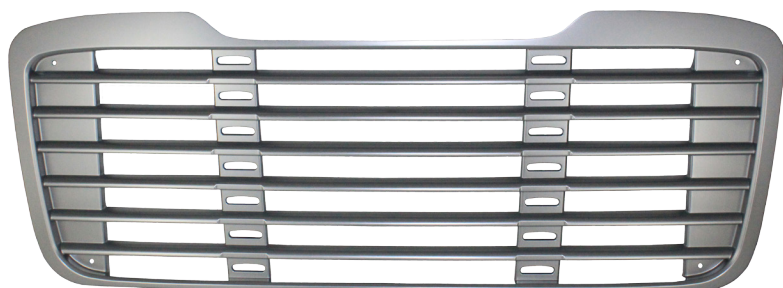

NEWSTAR<sup>®</sup> No.

**S-19521**

### GRILLE, PAINTED

**Replacement for**

Freightliner Number:

17-14787-000

A17-14787-000

- M2-106

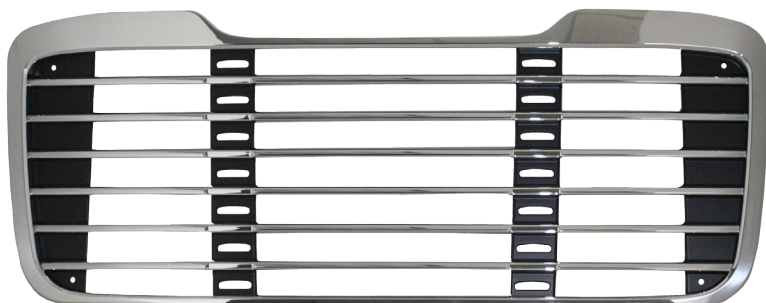

NEWSTAR<sup>®</sup> No.

**S-19522**

### GRILLE, CHROME

**Replacement for**

Freightliner Number:

17-14787-001

A17-14787-001

- M2-106



NEWSTAR<sup>®</sup> No.

**S-18207**

### GRILLE

**Replacement for**

Freightliner Number:

A17-12622-007

- FLD
- Brushed Aluminum





### GRILLE

 NEWSTAR<sup>®</sup> No.

**Replacement for**  
Freightliner Number:  
A17-12623-014

**S-18209**

- Century C112 - C120
- Chrome Outboard Hinge

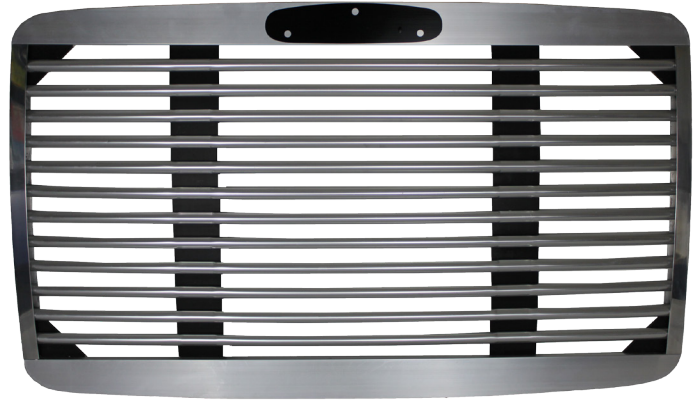

### GRILLE

 NEWSTAR<sup>®</sup> No.

**Replacement for**  
Freightliner Number:  
A17-12934-000

**S-20392**

- FLD Classic



### GRILLE

 NEWSTAR<sup>®</sup> No.

**Replacement for**  
Freightliner Number:  
A17-14768-000

**S-18217**

- FL60 / 70 / 80



Genuine  
 NEWSTAR<sup>™</sup>

# HOOD & BODY PARTS

## GRILLES

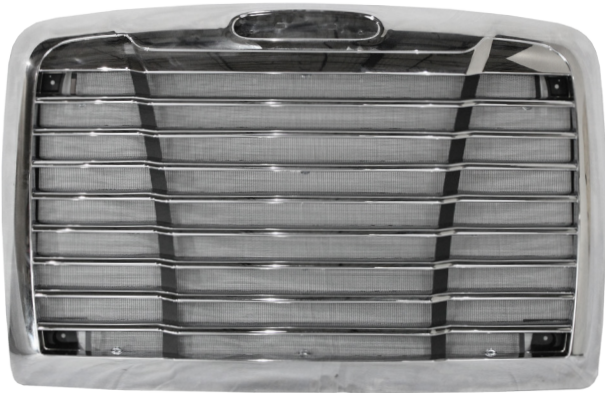

NEWSTAR No.

**S-18651**

### GRILLE WITH BUG SCREEN

**Replacement for**

Freightliner Number:

A17-15192-005

A17-16132-001

A17-16132-004

- Century C112 - C120
- Inboard Hinge



NEWSTAR No.

**S-18649**

### GRILLE

**Replacement for**

Freightliner Number:

A17-15251-000

A17-16515-002

- Columbia
- CL112 and CL120



NEWSTAR No.

**S-18650**

### GRILLE WITH BUG SCREEN

**Replacement for**

Freightliner Number:

A17-15251-002

A17-15251-003

- Columbia
- CL112 and CL120



### GRILLE WITH BUG SCREEN

 NEWSTAR<sup>™</sup> No.

**Replacement for**  
Freightliner Number:  
A17-15624-003  
A17-19112-000

**S-19106**

- Cascadia



### BUG SCREEN

 NEWSTAR<sup>™</sup> No.

**Replacement for**  
Freightliner Number:  
A22-65847-000

**S-19734**

- Columbia
- Fits on S-18649  
(Replacement for A17-15251-000)

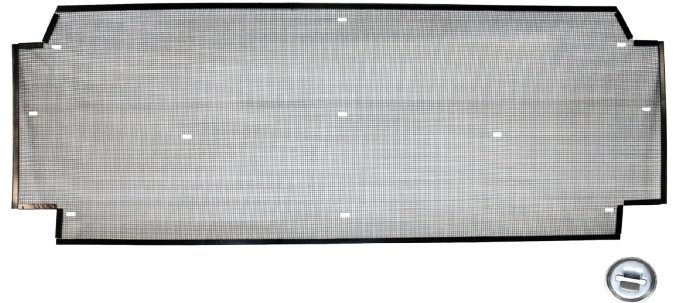

### GRILLE ISOLATOR

 NEWSTAR<sup>™</sup> No.

**Replacement for**  
Freightliner Number: 17-12127-000

**S-19995**

- FLD (Fits with FLD Grille)



### GRILLE ISOLATOR

 NEWSTAR<sup>™</sup> No.

**Replacement for**  
Freightliner Number: 23-12705-001

**S-20645**

- Columbia
- Fits S-18650  
(Replacement for A17-15251-003)



# HOOD & BODY PARTS

## HOODS



NEWSTAR No.

**S-18204**

### HOOD

**Replacement for**

Freightliner Number:  
A17-12442-002  
A17-12443-000

- FLD - 120
- 1988 and Earlier



NEWSTAR No.

**S-18894**

### HOOD

**Replacement for**

Freightliner Number:  
A17-12792-005  
A17-14024-009  
A17-14774-004  
A17-14774-009

- FL60 / 70 / 80



NEWSTAR No.

**S-18206**

### HOOD

**Replacement for**

Freightliner Number:  
A17-15092-002  
A17-15420-000

- Columbia and Century C120
- Outboard Hinge 1997-2002



### HOOD

 NEWSTAR<sup>™</sup> No.

**Replacement for**

Freightliner Number:  
A17-15457-002  
A17-15459-002

**S-19090**

- M2 - 106



### HOOD

 NEWSTAR<sup>™</sup> No.

**Replacement for**

Freightliner Number:  
A17-16035-000

**S-19110**

- M2 - 112



### HOOD

 NEWSTAR<sup>™</sup> No.

**Replacement for**

Freightliner Number:  
A17-16515-002

**S-18205**

- Columbia CL120 - FLC
- 2001 and Earlier



## Can't find what you're looking for?

For Additional Body Parts for popular International, Kenworth, Peterbilt, and Volvo Applications, check out our website at [www.sandstruck.com](http://www.sandstruck.com)

# HOOD & BODY PARTS

## HOOD ACCESSORIES



 NEWSTAR<sup>®</sup> No.

**S-20663**

### HOOD BRACKET, LEFT

#### Replacement for

Freightliner Number: A17-13787-002

- Columbia



 NEWSTAR<sup>®</sup> No.

**S-20664**

### HOOD BRACKET, RIGHT

#### Replacement for

Freightliner Number: A17-13787-003

- Columbia



 NEWSTAR<sup>®</sup> No.

**S-11940**

### HOOD CABLE TILT ASSIST

#### Replacement for

Freightliner Number: A17-12081-000

- FLD 12"

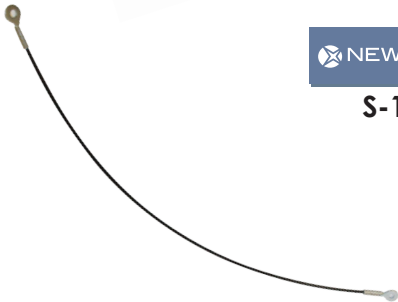

 NEWSTAR<sup>®</sup> No.

**S-11941**

### HOOD CABLE STOP ASSIST

#### Replacement for

Freightliner Number: A17-12082-000

- FLD 32"

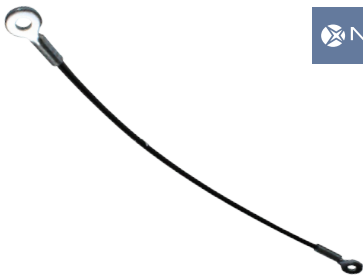

 NEWSTAR<sup>®</sup> No.

**S-19997**

### HOOD CABLE

#### Replacement for

Freightliner Number: A17-12082-002

- FLD 18"



# HOOD & BODY PARTS

## HOOD ACCESSORIES

### HOOD GUIDE

#### Replacement for

Freightliner Number: A17-10464-001

- FLD

 NEWSTAR<sup>®</sup> No.

**S-13329**



### HOOD HINGE BUSHING

#### Replacement for

Freightliner Number: LOR J17700 5

- FLD, Century, Columbia

 NEWSTAR<sup>®</sup> No.

**S-A797**



### HOOD LATCH, LEFT

#### Replacement for

Freightliner Number: 17-12435-000  
A17-12435-000

- FLD

 NEWSTAR<sup>®</sup> No.

**S-13326**

S-13326



### HOOD LATCH, RIGHT

#### Replacement for

Freightliner Number: 17-12435-001  
A17-12435-001

- FLD

 NEWSTAR<sup>®</sup> No.

**S-13327**

S-13327



### HOOD CATCH

#### Replacement for

Freightliner Number: 17-12434-000

- Fits FLD
- Works with S-13326  
(Replacement for A17-12435-000)
- Works with S-13327  
(Replacement for A17-12435-001)

 NEWSTAR<sup>®</sup> No.

**S-20616**

S-20616



### HOOD LATCH, COWL

#### Replacement for

Freightliner Number: 17-12438-000

- FLD Classic

 NEWSTAR<sup>®</sup> No.

**S-19253**



# HOOD & BODY PARTS

## HOODS ACCESSORIES

S-20526



 NEWSTAR<sup>®</sup> No.

**S-20526**

### HOOD LATCH

#### Replacement for

Freightliner Number: A 680 880 01 60

- M2
- Works with S-20611 (Replacement for 17-14781-000)

S-20611



 NEWSTAR<sup>®</sup> No.

**S-20611**

### HOOD CATCH

#### Replacement for

Freightliner Number: 17-14781-000

- M2 and FL
- Works with S-20526 (Replacement for A 680 880 01 60)



 NEWSTAR<sup>®</sup> No.

**S-18893**

### HOOD LATCH

#### Replacement for

Freightliner Number: A17-13534-000

- Century

S-18889



 NEWSTAR<sup>®</sup> No.

**S-18889**

### HOOD, CATCH

#### Replacement for

Freightliner Number: 17-13788-000

- Columbia
- Works with S-19251 (Replacement for A17-15553-000)
- Works with S-19252 (Replacement for A17-15553-001)

S-19251



 NEWSTAR<sup>®</sup> No.

**S-19251**

### HOOD LATCH, LEFT

#### Replacement for

Freightliner Number: A17-15553-000

- Columbia

S-19252



 NEWSTAR<sup>®</sup> No.

**S-19252**

### HOOD LATCH, RIGHT

#### Replacement for

Freightliner Number: A17-15553-001

- Columbia





# HOOD & BODY PARTS

## HOOD ACCESSORIES

### HOOD SPRING

#### Replacement for

Freightliner Number: 17-12069-001

- FLD, FLC and Classic

 NEWSTAR<sup>®</sup> No.

**S-20089**



### HOOD STRAP

#### Replacement for

Freightliner Number: A17-12994-002

- Columbia
- 33.50" Length

 NEWSTAR<sup>®</sup> No.

**S-19993**



### HOOD STRAP

#### Replacement for

Freightliner Number: A17-12994-003

- Cascadia
- 42" Length

 NEWSTAR<sup>®</sup> No.

**S-19994**



### HOOD TILT SHOCK

#### Replacement for

Freightliner Number: A17-19230-000

- Cascadia, Late Columbia

 NEWSTAR<sup>®</sup> No.

**S-20665**



Genuine  
 NEWSTAR<sup>™</sup>

# HOOD & BODY PARTS

## LIGHTS, LAMPS, AND FLASHERS



**NEWSTAR** No.

**S-5162**

### FLASHER

#### Replacement for

Freightliner Number: TNS TF0552TT002

- 12 Volt Mechanical

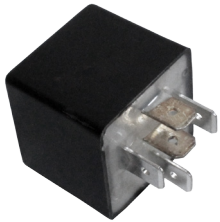

**NEWSTAR** No.

**S-9443**

### FLASHER

#### Replacement for

Freightliner Number: POT VF4-15F21 S01

- 12 Volt Mechanical



**NEWSTAR** No.

**S-A864**

### LAMP

#### Replacement for

Freightliner Number: TL 40202R3

- With Red Lens- 4 Inch Round Sealed Lamp



**NEWSTAR** No.

**S-14063**

### LAMP

#### Replacement for

Freightliner Number: TL 40002Y

- With Amber Lens-4 Inch Round with Grommet and Pigtail



**NEWSTAR** No.

**S-14111**

### LAMP / LENS

#### Replacement for

Freightliner Number: 681 544 01 03

- Red Lens with Grommet and Molded Pigtail



### **BRAKE LIGHT, LEFT**

 **NEWSTAR<sup>®</sup> No.**

**Replacement for**

Freightliner Number:  
A 681 544 04 03

- Medium Duty

**S-20056**

S-20056



S-20057



### **BRAKE LIGHT, RIGHT**

 **NEWSTAR<sup>®</sup> No.**

**Replacement for**

Freightliner Number:  
A 681 544 05 03

- Medium Duty

**S-20057**

### **HEADLIGHT BEZEL, LEFT**

 **NEWSTAR<sup>®</sup> No.**

**Replacement for**

Freightliner Number:  
06-32242-002

- Columbia
- Fits S-19777 (Replacement for A06-75737-004)

**S-18645**



S-18645

### **HEADLIGHT BEZEL, RIGHT**

 **NEWSTAR<sup>®</sup> No.**

**Replacement for**

Freightliner Number:  
06-32242-003

- Columbia
- Fits S-19778 (Replacement for A06-75737-005)

**S-18646**

S-18646



\*See Lamp Assemblies on Page 44

### **HEADLIGHT BEZEL, LEFT**

 **NEWSTAR<sup>®</sup> No.**

**Replacement for**

Freightliner Number:  
A06-20711-000

- Century

**S-20537**



S-20537

### **HEADLIGHT BEZEL, RIGHT**

 **NEWSTAR<sup>®</sup> No.**

**Replacement for**

Freightliner Number:  
A06-20711-001

- Century

**S-20538**

S-20538



Genuine  
 **NEWSTAR<sup>™</sup>**

# HOOD & BODY PARTS

## LIGHTS



S-19774

 NEWSTAR® No.

**S-19774**

### HEADLAMP ASSEMBLY

#### RIGHT

**Replacement for**

Freightliner Number:  
A06-75732-003

- M2



S-19775

 NEWSTAR® No.

**S-19775**

### HEADLAMP ASSEMBLY

#### LEFT

**Replacement for**

Freightliner Number:  
A06-75732-004

- M2



S-19777

 NEWSTAR® No.

**S-19777**

### HEADLAMP ASSEMBLY

#### LEFT

**Replacement for**

Freightliner Number:  
A06-75737-004

- Columbia Models



S-19778

 NEWSTAR® No.

**S-19778**

### HEADLAMP ASSEMBLY

#### RIGHT

**Replacement for**

Freightliner Number:  
A06-75737-005

- Columbia

\*See Bezels on Page 43



### CHROME BEZEL & SIGNAL LAMP

NEWSTAR<sup>™</sup> No.

#### LEFT

Replacement for  
Freightliner Number:  
A06-20738-000

S-19772

- FLD



### CHROME BEZEL & SIGNAL LAMP

NEWSTAR<sup>™</sup> No.

#### RIGHT

Replacement for  
Freightliner Number:  
A06-20738-001

S-19773

- FLD



### SIDE MARKER LAMP

Replacement for  
Freightliner Number: A06-21643-000

NEWSTAR<sup>™</sup> No.

S-20646

- FLD and Century 1996 TO 2008



### FOG LAMP

Replacement for  
Freightliner Number: A06-75742-000

NEWSTAR<sup>™</sup> No.

S-19894

- Columbia



### HEADLIGHT SWITCH

Replacement for  
Freightliner Number: UTA1457011

NEWSTAR<sup>™</sup> No.

S-4356

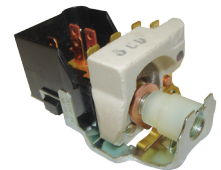

Genuine  
**NEWSTAR<sup>™</sup>**

# HOOD & BODY PARTS

## MIRRORS



**NEWSTAR** No.

**S-20648**

### MIRROR, HEATED

**Replacement for**

Freightliner Number:  
A22-58516-001

- Columbia and M2



**NEWSTAR** No.

**S-20777**

### HEATED CONVEX MIRROR

**Replacement for**

Freightliner Number: A22-59713-001

- Columbia and M2



**NEWSTAR** No.

**S-20649**

### MIRROR CHROME, HEATED

#### RIGHT

**Replacement for**

Freightliner Number:  
A22-59615-015

- M2



**NEWSTAR** No.

**S-20650**

### MIRROR CHROME, HEATED

#### LEFT

**Replacement for**

Freightliner Number:  
A22-59615-016

- M2



### FUEL TANK STRAP

#### Replacement for

Freightliner Number: 03-27310-001

- Columbia, Century and FLD
- Fits with S-19593 (Replacement for A03-28631-002)

 NEWSTAR<sup>®</sup> No.

**S-18857**



### FUEL TANK BAND

#### Replacement for

Freightliner Number: A03-28631-002  
A03-38910-000

- Columbia, Century, and FLD
- Works with S-18857 (Replacement for 03-27310-001 Strap)

 NEWSTAR<sup>®</sup> No.

**S-19593**



### AXLE STOP BUMPER

#### Replacement for

Freightliner Number: 16-15215-000

- Multiple Applications

 NEWSTAR<sup>®</sup> No.

**S-19980**



### STRIKER PIN KIT

#### Replacement for

Freightliner Number: A 681 721 02 K0

- Columbia, Century, and FLD

 NEWSTAR<sup>®</sup> No.

**S-20670**



# CAB

## CAB MOUNTS

S-20642



S-19966

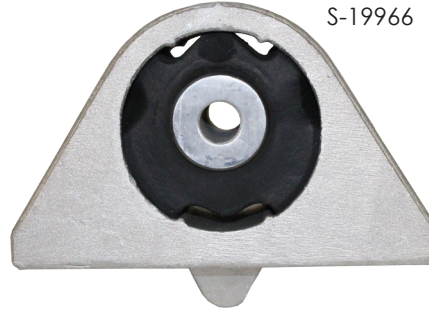

S-20565



S-20564



Newstar Number	Replacement for Freightliner Number	Description	Application
<b>S-20642</b>	18-41005-000	Cabin Mount	Columbia and Century
<b>S-19966</b>	18-45384-000	Cabin Mount	Columbia and Century
<b>S-20565</b>	A 681 890 00 01	Cabin Mount	FLD - Mates with S-20564 (Replacement for A681 891 0001)
<b>S-20564</b>	A 681 891 00 01	Cabin Mount	FLD - Mates with S-20565 (Replacement for A681 890 0001)

### Can't find what you're looking for?

For a complete listing of our Hood and Body products, please see our Hood and Body Parts catalog or visit the S & S Website at [www.sandstruck.com](http://www.sandstruck.com).





## TURN SIGNAL SWITCH

### Replacement for

Freightliner Number: 680 545 01 24  
A 680 545 01 24

- FL50/60/70/80 1994-2003

NEWSTAR<sup>®</sup> No.

**S-12069**

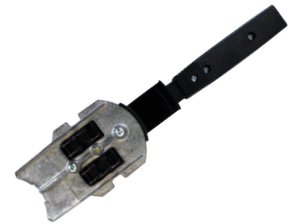

## TURN SIGNAL SWITCH

### Replacement for

Freightliner Number: A06-22743-002

- School Bus Models
- Grey with Dimmer and Hazard

NEWSTAR<sup>®</sup> No.

**S-20596**



## TURN SIGNAL SWITCH

### Replacement for

Freightliner Number: A06-44025-000

- Century, Columbia

NEWSTAR<sup>®</sup> No.

**S-20022**



## TURN SIGNAL SWITCH

### Replacement for

Freightliner Number: A14-13495-000

- Century, Columbia 1998-2003

NEWSTAR<sup>®</sup> No.

**S-12068**



## TURN SIGNAL SWITCH

### Replacement for

Freightliner Number: A14-13495-005

- Century, Columbia 1998-2003
- Coronado, FLD, and M2

NEWSTAR<sup>®</sup> No.

**S-18302**



## TURN SIGNAL SWITCH

### Replacement for

Freightliner Number: GRO-01-4811-77

- FLD

NEWSTAR<sup>®</sup> No.

**S-10275**



# CAB SWITCHES



**NEWSTAR** No.

**S-20674**

## TOGGLE SWITCH

### Replacement for

Freightliner Number: CTH 8956K895

- FLD



**NEWSTAR** No.

**S-20676**

## TOGGLE SWITCH

### Replacement for

Freightliner Number: CTH 8956K897

- FLD



**NEWSTAR** No.

**S-20675**

## TOGGLE SWITCH

### Replacement for

Freightliner Number: CTH 8956K913

- FLD



**NEWSTAR** No.

**S-20677**

## AIR PRESSURE SWITCH

### Replacement for

Freightliner Number: FSC 1749 1907

- Century and Columbia



**NEWSTAR** No.

**S-20678**

## CUT-OFF SWITCH

### Replacement for

Freightliner Number: FSC 1749 2134

- Century and Columbia



**NEWSTAR** No.

**S-20778**

## WINDOW SWITCH

### Replacement for

Freightliner Number: A06-30769-008

- Century and Columbia

## RANGE VALVE

### Replacement for

Freightliner Number: FUL A-6909

- 9 and 10 Speed Fuller Transmissions

 NEWSTAR No.

**S-C462**



## RANGE VALVE

### Replacement for

Freightliner Number: FUL A-6913

- 13 Speed Fuller Transmissions

 NEWSTAR No.

**S-C461**



## RANGE VALVE

### Replacement for

Freightliner Number: FUL A-6915

- 13 Speed Fuller Transmissions

 NEWSTAR No.

**S-C460**



## FLIPPER VALVE

### Replacement for

Freightliner Number: GTD 3222 1

- Multiple Freightliner Applications

 NEWSTAR No.

**S-C065**



# CAB

## CABIN AIR SPRINGS



**NEWSTAR<sup>®</sup> No.**

**S-18856**

### CAB TRANSMISSION LEVER BOOT

**Replacement for**

Freightliner Number: HUN 68D885

- Multiple Freightliner Applications



**NEWSTAR<sup>®</sup> No.**

**S-20126**

### CABIN AIR SPRING

**Replacement for**

Freightliner Number: 18-29919-000

- Century and Argosy COE 2002 and Earlier



**NEWSTAR<sup>®</sup> No.**

**S-20127**

### CABIN AIR SPRING

**Replacement for**

Freightliner Number: 18-52651-000

- Century, Columbia, FLD, Coronado, Cascadia



**NEWSTAR<sup>®</sup> No.**

**S-15566**

### CABIN AIR SPRING

**Replacement for**

Freightliner Number: 1S5-040  
GYR 1S5040

- Columbia, FLD and Century



## CLUTCH BRAKE

### Replacement for

Freightliner Number: SP 127200

- Universal- 2" Clutch

 NEWSTAR<sup>®</sup> No.

**S-15475**



## CLUTCH BRAKE, TORQUE LIMITING

### Replacement for

Freightliner Number: SP 127760

- Universal- 2" Clutch

 NEWSTAR<sup>®</sup> No.

**S-B039**

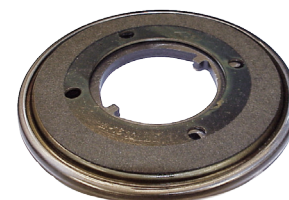

## CLUTCH FORK

### Replacement for

Freightliner Number: SP 105C137

- For 14 and 15 1/2' Clutches

 NEWSTAR<sup>®</sup> No.

**S-7440**



## CLUTCH ROD ASSEMBLY

### Replacement for

Freightliner Number: A02-12321-005  
A02-12765-002  
A02-13110-002

- Columbia, FLD, and Century

 NEWSTAR<sup>®</sup> No.

**S-18883**



## SWAY BAR ISOLATOR KIT

### Replacement for

Freightliner Number: 16-15496-000

- Sterling

 NEWSTAR<sup>®</sup> No.

**S-18487**



Genuine  
 NEWSTAR<sup>™</sup>

# CLUTCH



**NEWSTAR** No.

**S-20885**

## FLYWHEEL

### Replacement for

Freightliner Number: 23514177

- Detroit 60 Engines
- 12 Bolt Holes
- 15" Clutch
- Ring Gear 118 Teeth
- Pilot Bearing 306



**NEWSTAR** No.

**S-20886**

## FLYWHEEL

### Replacement for

Freightliner Number: 3680922

- Cummins ISX Engines
- 12 Bolt Holes
- 15" Clutch
- Ring Gear 113 Teeth
- Pilot Bearing 306

## Can't find what you're looking for?

For a complete listing of NEWSTAR Clutch Assemblies, check out our website at [www.sandstruck.com](http://www.sandstruck.com).

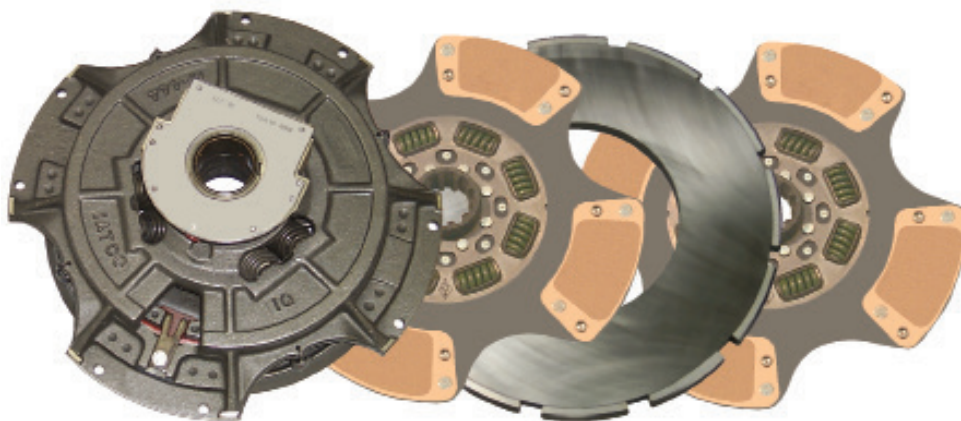



S-3347



S-19164

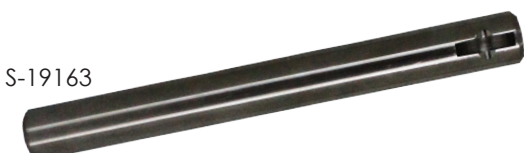

S-19163



S-20225

Newstar Number	Replacement for Freightliner Number	Description	Series
<b>S-3347</b>	02-09174-001 SP 106C1498	Clutch Release Shaft	Length 6 1/2"-For Spicer 14 and 15.5 Inch Clutches
<b>S-19164</b>	02-09788-007	Clutch Shaft	FLD
<b>S-19163</b>	02-12467-004	Clutch Shaft	Century and Columbia, Plain Finish
<b>S-20225</b>	02-12467-007	Clutch Shaft	Century and Columbia Zinc Plated

## PEDAL PAD

### Replacement for

Freightliner Number: 681 291 00 82  
A 681 291 00 82

- Century and M2

 **NEWSTAR<sup>®</sup> No.**

**S-19597**



## PILOT BEARING

### Replacement for

Freightliner Number: GAFP107206  
SBN 6305 2RSJSKF

- Multiple Applications

 **NEWSTAR<sup>®</sup> No.**

**S-11672**



Genuine  
 **NEWSTAR<sup>™</sup>**

# CLUTCH

## CLUTCH INSTALLATION KIT FOR HEAVY DUTY FULLER APPLICATION W/ 2" CLUTCH

 NEWSTAR® No.

**S-9971**

**Replacement for:**  
FUL K-2468



### Consists of:

Newstar Number	Replacement Number	Description
<b>S-15330</b>	-----	GASKET SET
<b>S-5761</b>	12815	BUSHING
<b>S-4596</b>	14750	SNAP RING
<b>S-9063</b>	16980	SNAP RING
<b>S-4312</b>	20550	RETAINER
<b>S-16421</b>	5566505	PILOT BEARING
<b>S-A018</b>	81504	CYLINDRICAL BEARING
<b>S-7440</b>	85533	CLUTCH FORK
<b>S-B039</b>	85535	TORQUE LIMITING BRAKE
<b>S-5501</b>	8677	BUSHING
<b>S-6519</b>	S-1659	INPUT SHAFT ASSY



## CLUTCH INSTALLATION KIT FOR HEAVY DUTY MERITOR APPLICATION W/ 2" CLUTCH

**NEWSTAR** No.

### S-20088

- Includes latest design front bearing cover engineered for smoother clutch brake surface with oil return grooves on the input shaft for maximum lube retention
- Long life pilot bearing with high temperature Viton seals to resist temperatures for today's hotter running engines
- Cross shaft bushings for improved throw out bearing life, smoother shifting, easier operation, and protection against costly clutch housing repairs



### Consists of:

Newstar Number	Replacement Number	Description
S-10309	KIT5367	INPUT SHAFT KIT
S-12006	3105K1155	RETAINER
S-7440	3296-Q-1239	FORK
S-16421	SBN 63062RS2C3SKF	VITON PILOT BEARING
S-B039	R160012	CLUTCH BRAKE 2"
S-A018	1228-G-1203	CYLINDRICAL BEARING
S-5761	12815	CLUTCH BUSHINGS (4 QTY)
S-4924	-----	GASKET TUBE

# DRIVELINE

## CENTER BEARINGS

Newstar Number	Replacement for Freightliner Number	Series	Height	Bearing Width	Mounting Holes**
----------------	-------------------------------------	--------	--------	---------------	------------------

### BEARING I.D. MAX/ MIN : 1.378" / 1.3775"

<b>S-7934</b>	SP 2100881X	1280,1310	2.25"	0.98"	6.63"
---------------	-------------	-----------	-------	-------	-------

### BEARING I.D. MAX/ MIN : 1.5748" / 1.5743"

<b>S-D460</b>	SP 2101401X	1350,1410,1480	2.44"	1.06"	6.63"
<b>S-7020</b>	SP 2103911X	1310,1410,1480	2.47"	1.06"	6.63"

### BEARING I.D. MAX/ MIN : 1.7717" / 1.7712"

<b>S-7935</b>	SP 2100842X	1550,1610,1650	2.69"	1.06"	7.63"
<b>S-D458</b>	SP 2101301X	1550,1610	2.69"	1.06"	7.63"

### BEARING I.D. MAX/ MIN : 1.9685" / 1.9680"

<b>S-1980</b>	TDA CB2101211X	1710	2.81"	1.19"	7.63"
---------------	----------------	------	-------	-------	-------

### BEARING I.D. MAX/ MIN : 2.3622" / 2.3616"

<b>S-7926</b>	SP 2106611X	1760,1810	3.38"	1.41"	8.63"
<b>*S-18847</b>	TDA CB210661 1XSA SP 5003323	1760,1810	3.38"	1.41"	8.63"
<b>S-B333</b>	SP 2108751X	1760,1810	3.38"	1.41"	8.63"

\*Self Aligning

\*\*Mounting Holes are Center to Center

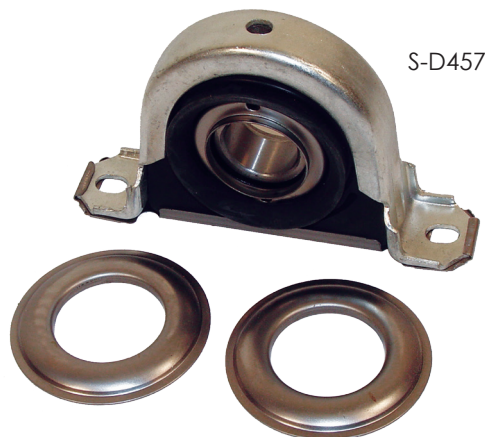



Newstar Number	Replacement Number	Description	Application
<b>S-19815</b>	23-12891-175 TDA CS-C8-20-52	Bolt	Bolts for "CP" Series U-Joints
<b>S-18553</b>	TDA K1TRPL2520	Bolt Kit	For RPL20 and 25 Series U-Joints Includes 4 Bolts and Snap Ring

## Can't find what you're looking for?

For a complete listing of all NEWSTAR Driveline components, including Universal Joints, Slip, End, and Weld Yokes, and Stub Shafts, go to [www.sandstruck.com](http://www.sandstruck.com).

# DRIVELINE

## UNIVERSAL JOINTS

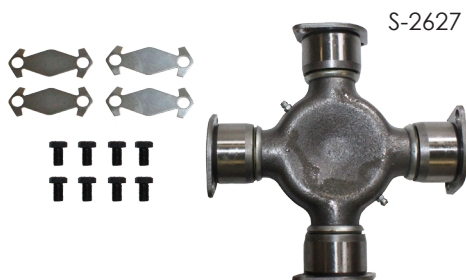

Newstar Number	Replacement for Freightliner Number	Description	Series
<b>S-13529</b>	TDA CP20RPLS	Universal Joint	20 RPL Series
<b>S-13530</b>	TDA CP25RPLS	Universal Joint	25 RPL Series
<b>S-7435</b>	TDA CP280X	Universal Joint	1710 Series
<b>S-7434</b>	TDA R279X	Universal Joint	1610 Series
<b>S-7435</b>	TDA R280X	Universal Joint	1710 Series
<b>S-2627</b>	TDA R281X	Universal Joint	1810 Series
<b>S-6099</b>	TDA R407X	Universal Joint	1760 Series
<b>S-C472</b>	TDA R674X	Universal Joint	1610 Series
<b>S-C473</b>	TDA R675X	Universal Joint	1710 Series
<b>S-C474</b>	TDA R676X	Universal Joint	1810 Series
<b>S-C475</b>	TDA R677X	Universal Joint	1760 Series
<b>S-E129</b>	TDA US90X	Universal Joint	-----
<b>S-E358</b>	TDA US170X	Universal Joint	-----
<b>S-E359</b>	TDA US250X	Universal Joint	-----



## N14 ACCESSORY DRIVE

### Replacement for

Freightliner Number: CUM 3078307

- Application: Cummins N14

 NEWSTAR® No.

**S-20025**



## ALTERNATOR

### Replacement for

Freightliner Number: DR 19011176

- 34SI Series-12 Volt-135 AMP-Pad Mount

 NEWSTAR® No.

**S-10134**



## ALTERNATOR

### Replacement for

Freightliner Number: DR 19020309

- 22SI Series-12 Volt-145 AMP

 NEWSTAR® No.

**S-E230**



## STARTER

### Replacement for

Freightliner Number: DR 10461075  
DR 1990428

- 42MT Series with Overcrank Protection

 NEWSTAR® No.

**S-16660**





 NEWSTAR<sup>™</sup> No.

**S-E226**

## STARTER

### Replacement for

Freightliner Number: DR 1990483  
DR 1990352

- 42MT Series -12 Volt- 11 Tooth Pinion



 NEWSTAR<sup>™</sup> No.

**S-18488**

## WIRING HARNESS

### Replacement for

Freightliner Number: 06-30361-000

## Can't find what you're looking for?

For a complete listing of NEWSTAR products, check out our website at [www.sandstruck.com](http://www.sandstruck.com).

# ENGINE

## FAN CLUTCH, BELTS, AND GASKETS

### OIL PUMP

NEWSTAR<sup>®</sup> No.

#### Replacement for

Freightliner Number:  
DDE 23505886

S-18434

- Application Detroit 60 Engines



### REMANUFACTURED DRIVEMASTER<sup>®</sup> REPAIR KIT

NEWSTAR<sup>®</sup> No.

#### Replacement for

Freightliner Number:  
HOR 994985

S-18298

- Consists of new wear parts and remanufactured Horton Components.
- DriveMaster<sup>®</sup> is a registered trademark of Horton Inc.



### FAN CLUTCH SOLENOID W/ HARNESS

NEWSTAR<sup>®</sup> No.

#### Replacement for

Freightliner Number: A06-26631-000

S-18706

- Female Inlet Ports 1/8"-27 NPTF
- Male Outlet Port 1/8"-27 NPTF
- Columbia, FLD, Century, and M2



Genuine  
NEWSTAR<sup>™</sup>

# ENGINE

## FAN CLUTCH, BELTS, AND GASKETS

### BELTS

Newstar Number	Gates Number	Industry Number	Freightliner Number	Type
<b>S-11896</b>	17510, 17511, 17512	13A1295	23-10001-037	V Belt P.S., w/o A.C.
<b>S-15410</b>	K080560	8PK1427	GT4080562DF	Serpentine Belt Fan & Alt. (56 1/2 In. Belt)
<b>S-15411</b>	K080575	8PK1460	01-27116-006	Serpentine Belt Fan & Idler (58 In. Belt)
<b>S-15421</b>	K060507	6PK1285	01-23683-003	Belt 6 Rib
<b>S-15423</b>	K060560	6PK1420	01-26709-008	Belt 6 Rib
<b>S-15424</b>	K060575	6PK1460	01-26709-009	Belt 6 Rib
<b>S-15425</b>	K080672	8PK1705	01-27086-003 01-27086-004	Belt 8 Rib
<b>S-15426</b>	K080785	8PK1994	01-27110-013	Belt 8 Rib
<b>S-15428</b>	K080855	8PK2170	01-27116-004 01-28330-003	Belt 8 Rib
<b>S-15430</b>	K090609	9PK1548	01-27198-001	Belt 9 Rib
<b>S-15431</b>	K060441	8PK1115	01-29730-115	Belt 6 Rib
<b>S-15432</b>	K080825	8PK2095	01-29866-094	Belt 8 Rib
<b>S-17473</b>	K100502	10PK1275	01-24894-004	V-Belt
<b>S-15414</b>	K100579	10PK1473	01-24894-000	Belt Fan
<b>S-17460</b>	K060547	6PK1390	01-26709-007	Belt 6 Rib
<b>S-15427</b>	K080610	8PK1550	01-27110-023	Belt 8 Rib
<b>S-15418</b>	K080537	8PK1365	01-23415-004	Belt 8 Rib
<b>S-15345</b>	K080740	8PK1880	01-23415-046	Belt 8 Rib
<b>S-15417</b>	K080605	8PK1535	MBT A68199707	Belt 8 Rib
<b>S-15415</b>	-----	8PK1251	MBT A68199705	Belt Fan
<b>S-15441</b>	K080952	8PK2415	01-23415-061	Belt 8 Rib
<b>S-15344</b>	TR28412	22A1055	23-10001-089	V-Belt
<b>S-15435</b>	K060598	6PK1520	01-23683-004	Belt 6 Rib
<b>S-17505</b>	K060637	6PK1620	01-26709-018	Belt 6 Rib
<b>S-17509</b>	K080530	8PK1345	01-27110-022	Belt 8 Rib
<b>S-17517</b>	K080939	8PK2385	02-23415-053 01-27110-038	Belt 8 Rib
<b>S-17542</b>	K081005	8PK2555	01-23415-080	Belt 8 Rib
<b>S-17544</b>	K081124	8PK2855	01-27110-059 01-23415-093	Belt 8 Rib
<b>S-15533</b>	K080939	8PK2390	01-23415-053	Belt 8 Rib
<b>S-17476</b>	K060685	6PK1740	01-24196-010	Belt 6 Rib





# ENGINE

## FAN CLUTCH, BELTS, AND GASKETS

### DIPSTICK TUBE

#### Replacement for

Freightliner Number: A01-16025-006

- Cummins L10 Engine

 NEWSTAR<sup>®</sup> No.

**S-A906**



### OIL PAN GASKET

#### Replacement for

Freightliner Number: 23522279  
DDE 23522279

- Fits Detroit 60 Engines

 NEWSTAR<sup>®</sup> No.

**S-18719**



### OIL PAN GASKET

#### Replacement for

Freightliner Number: 8929102  
DDE 8929102

- Fits Detroit 60 Engines

 NEWSTAR<sup>®</sup> No.

**S-18718**



### ROCKER COVER GASKET

#### Replacement for

Freightliner Number: 23516322  
DDE 23516322

- Fits Detroit 60 Engines

 NEWSTAR<sup>®</sup> No.

**S-18720**



### ROCKER COVER GASKET

#### Replacement for

Freightliner Number: DDE 23522269  
DDE 23539103

- Fits Detroit 60 Engines

 NEWSTAR<sup>®</sup> No.

**S-20655**

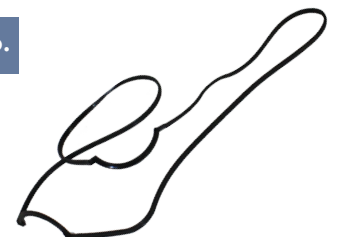

*Genuine*  
 **NEWSTAR<sup>™</sup>**

# ENGINE SENSORS



 NEWSTAR<sup>™</sup> No.

**S-20812**

## WATER TEMPERATURE SENSOR

### Replacement for

Freightliner Number: DDE 23514708

- Application: Detroit Diesel
- 3/4" NPT



 NEWSTAR<sup>™</sup> No.

**S-20811**

## WATER TEMPERATURE SENSOR

### Replacement for

Freightliner Number: DDE 23515251

- Application: Detroit Diesel
- 3/4" NPT, Brass



 NEWSTAR<sup>™</sup> No.

**S-20810**

## ABS SPEEDO SENSOR

### Replacement for

Freightliner Number: SAA 85920038

- Application: Meritor ABS Brakes



 NEWSTAR<sup>™</sup> No.

**S-20809**

## COOLANT LEVEL SENSOR

### Replacement for

Freightliner Number: DDE 23520380

- Application: Detroit Diesel
- 1/4"-18 NPTF Threads

## ENGINE MOUNT, REAR

### Replacement for

Freightliner Number: BCD 27330 1

- Columbia and Century
- Mates with S-19293 (Replacement for BCD 28805 1)

NEWSTAR<sup>®</sup> No.

**S-19292**



## ENGINE MOUNT, REAR

### Replacement for

Freightliner Number: BCD 27330 2

- Columbia, Century and Cascadia
- Mates with S-19293 (Replacement for BCD 28805 1)

NEWSTAR<sup>®</sup> No.

**S-20672**



## ENGINE MOUNT, REAR

### Replacement for

Freightliner Number: BCD 27477 2  
BCD 28805 1

- Columbia and Century
- Mates with S-19292 (Replacement for BCD 273301)
- Mates with S-20672 (Replacement for BCD 273302)

NEWSTAR<sup>®</sup> No.

**S-19293**



## ENGINE MOUNT, UPPER FRONT

### Replacement for

Freightliner Number: BCD 27651 2

- Columbia and Century
- Mates with S-19291 (Replacement for BCD 28945 1)

NEWSTAR<sup>®</sup> No.

**S-20314**



## ENGINE MOUNT, ISOLATOR

### Replacement for

Freightliner Number: BCD 27651 3

- Colombia and Century
- Mates with S-19291 (Replacement for BCD 28945 1)

NEWSTAR<sup>®</sup> No.

**S-20315**



# ENGINE MOUNTS



 NEWSTAR<sup>™</sup> No.

**S-19317**

## ENGINE MOUNT, REAR

### Replacement for

Freightliner Number: LOR CBA24 650 17

- FLD



 NEWSTAR<sup>™</sup> No.

**S-19998**

## ENGINE MOUNT, REAR

### Replacement for

Freightliner Number: LOR J20941 6

- FLD, Early Columbia, Early Century



 NEWSTAR<sup>™</sup> No.

**S-19525**

## ENGINE MOUNT, REAR

### Replacement for

Freightliner Number: LOR SSB33 10017

- FLD, Century, Columbia and M2



 NEWSTAR<sup>™</sup> No.

**S-19334**

## ENGINE MOUNT, FRONT

### Replacement for

Freightliner Number: LOR SSB33 10018

- FLD, Century, Columbia and M2



 NEWSTAR<sup>™</sup> No.

**S-19291**

## ISOLATOR

### Replacement for

Freightliner Number: BCD 28945 1

- Lower Engine Support
- For Columbia and Century Class
- Mates with S-20314 (Replacement for BCD 27651 2)
- Mates with S-20315 (Replacement for BCD 27651 3)



# ENGINE SENSORS, RELAYS, SENDERS, AND SOLENOIDS



Newstar Number	Replacement for Freightliner Number	Description	Series
<b>S-20628</b>	A22-42390-005	Fuel Sender	FLD, FLD Classic
<b>S-20629</b>	A22-68359-000	Fuel Sender	Columbia, Century, M2, Cascadia, and Coronado



S-18706



S-18497



S-D895



S-18268

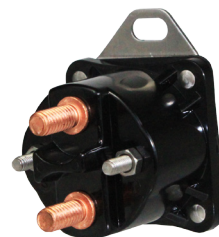

S-19127

Newstar Number	Replacement for Freightliner Number	Description	Series
<b>S-18706</b>	A06-26631-000	Fan Clutch Solenoid	M2, FLD, Century and Columbia
<b>S-18497</b>	06-26989-000	Magnetic Solenoid	Remote Mount Starter Solenoid- 12 Volt
<b>S-D895</b>	DR 1115556	Solenoid Switch	Universal Delco Design- 12 Volt
<b>S-18268</b>	ESX 120-105112-2	Magnetic Solenoid	FLD
<b>S-19127</b>	LN SAZ4201BR	Magnetic Solenoid	Century and Columbia

# ENGINE

## SENSORS, RELAYS, SENDERS, AND SOLENOIDS

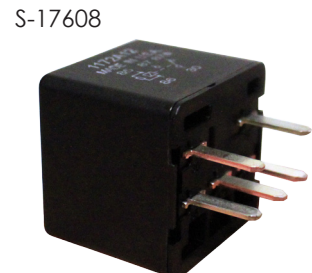
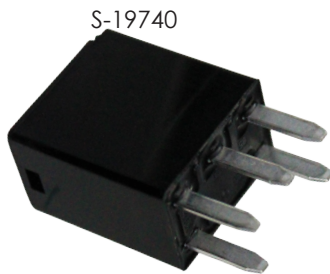

Newstar Number	Replacement for Freightliner Number	Description	Series
<b>S-19740</b>	23-13265-001	Micro Relay	5 Terminal, Universal 12 Volt
<b>S-9443</b>	POT VF4 15F21 S01	Relay	5 Terminal, 12 Volt, 40 AMP
<b>S-A859</b>	SOG 8961CR1U0312S POT VF4 15F11	Micro Relay	5 Terminal, 12 Volt, 10 AMP
<b>S-17608</b>	POT VF28 15F14 C05 SOG 898H1CR1U0312S	Relay	5 Terminal, 12 Volt



### ISO Certification Announcement!

S & S Truck Parts, Inc is proud to announce it is now certified as an ISO 9001:2008 compliant organization. The certification is accredited by Perry Johnson Registrars (PJR).

The certification of compliance with ISO 9001:2008 recognizes that the policies, practices, and procedures of our company ensure consistent quality in the product and services we provide our clients. With this certification, our clients can be confident that S and S Truck Parts, Inc is dedicated to maintaining the highest efficiency and responsiveness in achieving our ultimate goal – guaranteed client satisfaction.





Newstar Number	Replacement for Freightliner Number	Description	Special Features
<b>S-B339</b>	ABP N35 30PLS	Clamp	3" Stainless Preformed
<b>S-C110</b>	ABP N35 35PLA	Clamp	3.5" Aluminized Preformed
<b>S-8476</b>	ABP N35 40PLA	Clamp	4" Aluminized Preformed
<b>S-D424</b>	ABP N35 40PLS	Clamp	4" Stainless Preformed
<b>S-7687</b>	ABP N35 50PLA	Clamp	5" Aluminized Preformed
<b>S-4332</b>	ABP N35 400UBRS	Clamp	4" U-Bolt Saddle
<b>S-4333</b>	ABP N35 500UBRS	Clamp	5" U-Bolt Saddle
<b>S-9414</b>	BRZ B9224-0411 FR U B	Clamp	Turbo Clamp Size Range 4-1/8 to 4-7/16"
<b>S-14057</b>	BRZ B9226-0406	Clamp	Turbo Clamp Size Range 4.06 to 4.37"
<b>S-A862</b>	CIU500F1	Clamp	U-Bolt Saddle Design for 5" Exhaust
<b>S-B068</b>	DNX004478	Clamp	3" Stainless Flat Band
<b>S-4965</b>	DNX004482	Clamp	4" Stainless Flat Band
<b>S-4966</b>	DNX004484	Clamp	5" Stainless Flat Band
<b>S-A910</b>	DNX006202	Clamp	For 5" Exhaust Pipes Flat Band Aluminized
<b>S-18652</b>	GAFP114238	Clamp	Bolt Turbo Clamp 3.22 to 3.60"
<b>S-7537</b>	RAY 10028-006	Clamp	Turbo 4.61"
<b>S-A999</b>	RKR 50PLB	Clamp	Exhaust 5" Stainless Preformed
<b>S-A914</b>	RKR U500PL	Clamp	Exhaust 5" Chrome Saddle and U-Bolt Design
<b>S-5222</b>	HDC 21215 RAY 001010001	Clamp	Turbo 5"

## EXHAUST PIPE

### Replacement for

Freightliner Number: GAFP117306

- Exhaust 2.75"

 NEWSTAR No.

**S-20283**



## FLEX TUBING

### Replacement for

Freightliner Number: GAFP114646

- Exhaust 3.5" ID X 19" Long Galvanized

 NEWSTAR No.

**S-19062**



Genuine  
 **NEWSTAR™**

# EXHAUST



 NEWSTAR<sup>®</sup> No.

**S-18664**

## FLEX TUBING

### Replacement for

Freightliner Number: GAFP117693

- Exhaust 3.5" X 22" Stainless



 NEWSTAR<sup>®</sup> No.

**S-A995**

## MUFFLER

### Replacement for

Freightliner Number: DNM100465

- 10" Diameter Round X 51" Long, 5" Inlet and Outlet



 NEWSTAR<sup>®</sup> No.

**S-18825**

## TAILPIPE

### Replacement for

Freightliner Number: 04-21421-000

- Rear Pipe for FLD
- 3.5" Exhaust



 NEWSTAR<sup>®</sup> No.

**S-19176**

## TAILPIPE

### Replacement for

Freightliner Number: GAFP115559

- Exhaust 3.5"



 NEWSTAR<sup>®</sup> No.

**S-18494**

## TAILPIPE EXTENSION

### Replacement for

Freightliner Number: GAFP116403

- Exhaust 3.5"



 NEWSTAR<sup>®</sup> No.

**S-20394**

## EXHAUST ISOLATOR

### Replacement for

Freightliner Number: 04-19919-000



 NEWSTAR<sup>®</sup> No.

**S-20902**

## PIPE, MUFFLER INLET

### Replacement for

Freightliner Number: 04-22338-000

- 5" Exhaust





## BLOWER MOTOR, SHORT WIRE

### Replacement for

Freightliner Number: ABP N83 301137  
BOA 80 415 00789

- Early FLD

 NEWSTAR<sup>®</sup> No.

**S-B398**



## BLOWER MOTOR, LONG WIRE

### Replacement for

Freightliner Number: ABP N83 301017

- FLD

 NEWSTAR<sup>®</sup> No.

**S-18721**



## BLOWER MOTOR

### Replacement for

Freightliner Number: BOA D8587

- Columbia

 NEWSTAR<sup>®</sup> No.

**S-18270**



## BLOWER MOTOR

### Replacement for

Freightliner Number: ABP N83 301527

- Century

 NEWSTAR<sup>®</sup> No.

**S-11455**



# HVAC

## COMPRESSORS



 NEWSTAR<sup>®</sup> No.

**S-18995**

### A/C COMPRESSOR

#### Replacement for

Freightliner Number: 4417  
ABP N83 304543  
SKI 4417

- Detroit 60 Engines for Century, Columbia, M2, Cascadia, and Coronado



 NEWSTAR<sup>®</sup> No.

**S-17955**

### A/C COMPRESSOR

#### Replacement for

Freightliner Number: ABP N83 304061T

- Columbia, Century, FLD, and M2
- York/Tecumseh Style



 NEWSTAR<sup>®</sup> No.

**S-19249**

### A/C COMPRESSOR

#### Replacement for

Freightliner Number: ABP N83 304201T

- Columbia, Century, FLD, and M2
- York/Tecumseh Style with Pulley



## CONDENSER

 NEWSTAR™ No.

**Replacement for**  
Freightliner Number:  
22-32466-001

**S-16264**

- FLD and Early Century

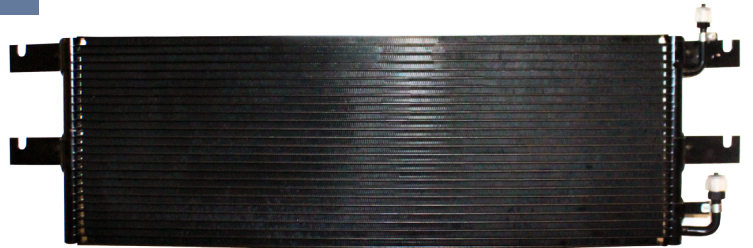

## CONDENSER

 NEWSTAR™ No.

**Replacement for**  
Freightliner Number:  
22-42084-000  
22-42084-002  
BOA 3101211TC

**S-11405**

- Century



## CONDENSER

 NEWSTAR™ No.

**Replacement for**  
Freightliner Number:  
5104114AA

**S-18727**

- Dodge Sprinter



## CONDENSER

 NEWSTAR™ No.

**Replacement for**  
Freightliner Number:  
A22-66825-000  
A22-66840-000  
A22-67126-000

**S-19639**

- Cascadia, Late Model Columbia  
and Century
- Parallel Flow Version



 NEWSTAR™

# HVAC

## CONDENSERS

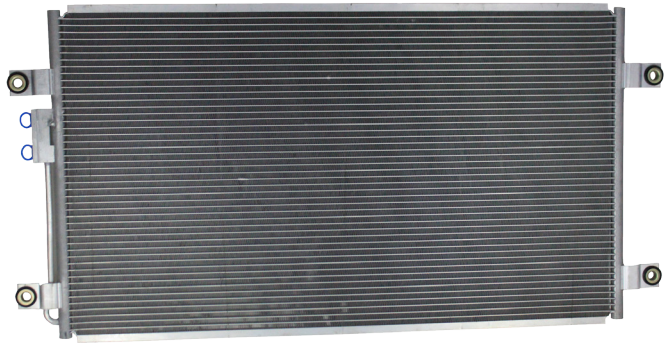

NEWSTAR<sup>®</sup> No.

**S-19610**

### CONDENSER

**Replacement for**

Freightliner Number:  
A22-66839-000  
A22-67125-000  
A22-65663-000  
A22-66824-000

- Cascadia, Late Columbia, Century, Coronado, FLD, and FLD Classic
- DDA 60 Engine Only
- Parallel Flow Version

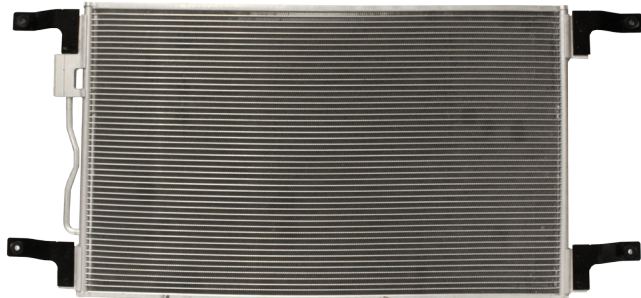

NEWSTAR<sup>®</sup> No.

**S-16265**

### CONDENSER

**Replacement for**

Freightliner Number:  
MOD 1E6068  
BHT 79465  
BHT 92710  
MOD 1E5864

- FLD, Century, FLD Classic, and Colombia

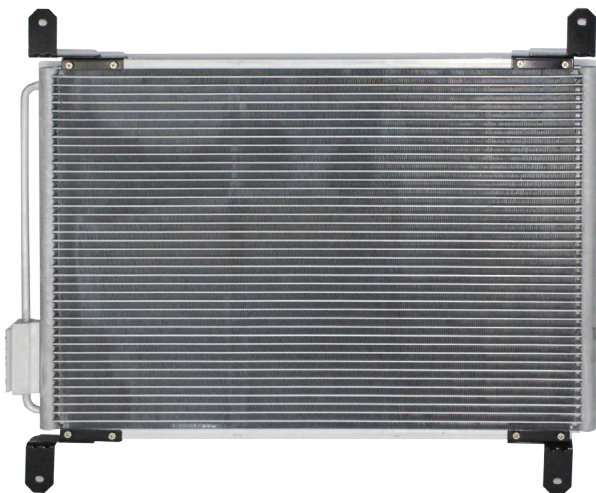

NEWSTAR<sup>®</sup> No.

**S-19499**

### CONDENSER

**Replacement for**

Freightliner Number:  
BHT E2108  
BHT P5631001

- M2

### EXPANSION VALVE

#### Replacement for

Freightliner Number: A4965  
BOA A4965

- Columbia, Century, and FLD

 NEWSTAR<sup>®</sup> No.

**S-18924**



### EXPANSION VALVE

#### Replacement for

Freightliner Number: ABP N83 308011

- FLD Sleeper Units

 NEWSTAR<sup>®</sup> No.

**S-18824**



### EXPANSION VALVE

#### Replacement for

Freightliner Number: ABP N83 308375

- FLD, Classic, and Columbia

 NEWSTAR<sup>®</sup> No.

**S-19357**



### EXPANSION VALVE

#### Replacement for

Freightliner Number: BOA 803210026900

- Columbia and Century

 NEWSTAR<sup>®</sup> No.

**S-20458**



### EXPANSION VALVE

#### Replacement for

Freightliner Number: BOA 93674

- Columbia, Century and FLD

 NEWSTAR<sup>®</sup> No.

**S-18875**



Genuine  
 **NEWSTAR<sup>™</sup>**

# HVAC

## RECEIVER DRYERS



**NEWSTAR<sup>®</sup> No.**

**S-18725**

### RECEIVER DRYER

**Replacement for**

Freightliner Number: ABP N83 319614

- Columbia and FLD



**NEWSTAR<sup>®</sup> No.**

**S-20393**

### RECEIVER DRYER

**Replacement for**

Freightliner Number: A22-63992-001  
A22-63992-000

- Cascadia and Late Columbia



**NEWSTAR<sup>®</sup> No.**

**S-18724**

### RECEIVER DRYER

**Replacement for**

Freightliner Number: ABP N83 319744  
PH 088539 00

- Columbia, Century and FLD



### BINARY SWITCH

#### Replacement for

Freightliner Number: 22-51296-000

- Columbia, FLD and Century

NEWSTAR<sup>®</sup> No.

S-20461



### WATER VALVE ASSEMBLY

#### Replacement for

Freightliner Number: 173119N

- FLD and Century
- Kysor Air and Heating Systems

NEWSTAR<sup>®</sup> No.

S-18269

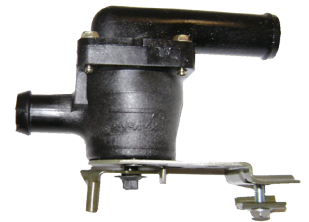

### SEALING RING

#### Replacement for

Freightliner Number: 23-13201-000

- M2, Columbia, and Century
- Fits S-18724 (Replacement for ABP N83 319744)

NEWSTAR<sup>®</sup> No.

S-19798



### SEALING RING

#### Replacement for

Freightliner Number: 23-13202-000

- Columbia, Century and M2
- Fits AC Compressors

NEWSTAR<sup>®</sup> No.

S-19526



### SEALING RING

#### Replacement for

Freightliner Number: 23-13205-000

- Columbia, Century and M2
- Fits AC Compressors

NEWSTAR<sup>®</sup> No.

S-19799



### AIR CYLINDER

#### Replacement for

Freightliner Number: ARS BVC3A

- Columbia and Century

NEWSTAR<sup>®</sup> No.

S-19498



Genuine  
NEWSTAR<sup>™</sup>

# HVAC

## MISCELLANEOUS



**NEWSTAR<sup>®</sup> No.**

**S-20436**

### ACTUATOR

**Replacement for**

Freightliner Number: BOA 91594

- Century and Columbia



**NEWSTAR<sup>®</sup> No.**

**S-20607**

### TEMPERATURE SENSOR

**Replacement for**

Freightliner Number: BOA 91619

- Century and Columbia



**NEWSTAR<sup>®</sup> No.**

**S-18958**

### EVAPORATOR

**Replacement for**

Freightliner Number:  
BOA 91616

- Century and Columbia



**NEWSTAR<sup>®</sup> No.**

**S-18728**

### HEATER CORE

**Replacement for**

Freightliner Number:  
BOA 93675

- Century, Columbia, and FLD





# RADIATORS, CHARGE AIR COOLERS AND SURGE TANKS

## CHARGED AIR COOLER

NEWSTAR<sup>®</sup> No.

**Replacement for**  
Freightliner Number:  
01-23132-000

**S-19888**

- FLD



## CHARGED AIR COOLER

NEWSTAR<sup>®</sup> No.

**Replacement for**  
Freightliner Number:  
01-31241-000

**S-19955**

- Cascadia



## CHARGED AIR COOLER

NEWSTAR<sup>®</sup> No.

**Replacement for**  
Freightliner Number:  
01-31242-000

**S-19954**

- Cascadia



## CHARGED AIR COOLER

NEWSTAR<sup>®</sup> No.

**Replacement for**  
Freightliner Number:  
BHT D3526

**S-19956**

- Coronado with Detroit 60 DD15



Genuine  
**NEWSTAR<sup>™</sup>**

# RADIATORS, CHARGE AIR COOLERS AND SURGE TANKS

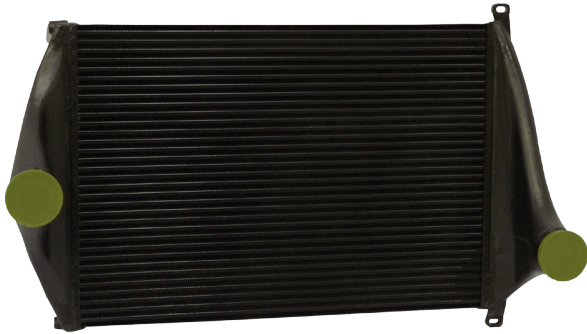

**NEWSTAR<sup>®</sup> No.**

**S-17115**

## CHARGED AIR COOLER

### Replacement for

Freightliner Number:  
BHT D3521

- Century and M2



**NEWSTAR<sup>®</sup> No.**

**S-17116**

## CHARGED AIR COOLER

### Replacement for

Freightliner Number:  
BHT D3523  
MOD 1E6017

- Columbia



**NEWSTAR<sup>®</sup> No.**

**S-20530**

## HOSE CLAMP

### Replacement for

Freightliner Number: 23-12201-250

- Century and Columbia
- Range- 2.69" to 3"



**NEWSTAR<sup>®</sup> No.**

**S-20224**

## HOSE CLAMP

### Replacement for

Freightliner Number: 23-12485-250

- Century, Columbia, FLD, M2, Coronado, and Cascadia
- Range- 2-9/16" to 3-1/2"



# RADIATORS, CHARGE AIR COOLERS AND SURGE TANKS

## RADIATOR

 NEWSTAR No.

### Replacement for

Freightliner Number:  
05-16366-004  
A05-16366-004  
310011T

**S-11398**

- FLD112/120



## RADIATOR

 NEWSTAR No.

### Replacement for

Freightliner Number:  
05-29617-003

**S-20712**

- Cascadia
- Plastic and Aluminum
- Height- 41-5/8", Length- 38"

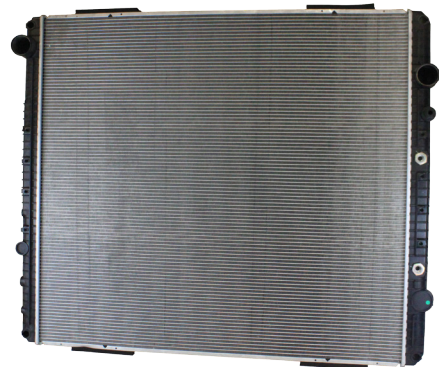

## RADIATOR

 NEWSTAR No.

### Replacement for

Freightliner Number:  
05-29617-005

**S-20586**

- Cascadia 2008 and Later
- Plastic and Aluminum
- Height- 42-1/8", Length- 38"

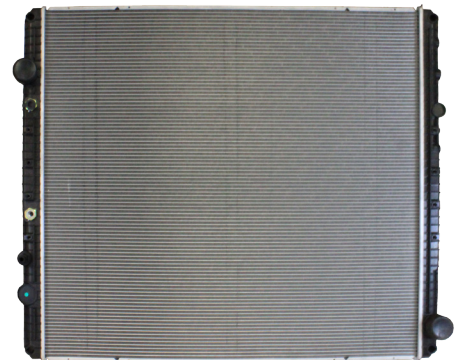

## RADIATOR

 NEWSTAR No.

### Replacement for

Freightliner Number:  
BHT A6724  
BHT A6725002  
BHT B4763002

**S-11397**

- Columbia, Century, and M2



*Genuine*  
 **NEWSTAR™**

# RADIATORS, CHARGE AIR COOLERS AND SURGE TANKS

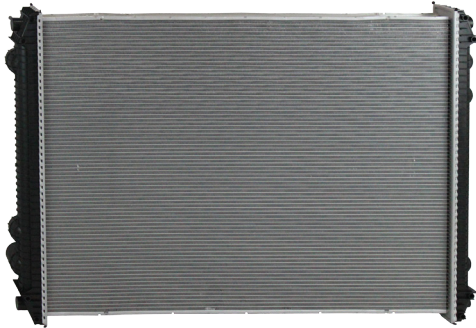

**NEWSTAR** No.

**S-18929**

## RADIATOR

### Replacement for

Freightliner Number:  
BHT U3692001

- Century and Columbia



**NEWSTAR** No.

**S-20037**

## RADIATOR MOUNTING PIN

### Replacement for

Freightliner Number: EXO 7AH00038-01-SP

- Century and Columbia
- Use with S-18929 (Replacement for BHT U3692001)
- Use with S-11397 (Replacement for BHT A6725002)



**NEWSTAR** No.

**S-19782**

## RADIATOR ISOLATOR

### Replacement for

Freightliner Number: 05-16070-000

- Century, Columbia and FLD



**NEWSTAR** No.

**S-19891**

## RADIATOR ISOLATOR

### Replacement for

Freightliner Number: LOR CB220273

- Century and Columbia Truck



**NEWSTAR** No.

**S-20673**

## RADIATOR MOUNT

### Replacement for

Freightliner Number: BCD 28847 1

- Colombia and Century



# RADIATORS, CHARGE AIR COOLERS AND SURGE TANKS

## RADIATOR MOUNT

### Replacement for

Freightliner Number: CB-1120  
CB1120-3  
LOR CB1120 3

- Columbia / Century

 NEWSTAR<sup>®</sup> No.

**S-20014**



## SIGHT GLASS

### Replacement for

Freightliner Number: VML T3248

- Part of VML T1555

 NEWSTAR<sup>®</sup> No.

**S-E849**



## SURGE TANK

### Replacement for

Freightliner Number:  
05-23045-000  
05-23045-001

- Century, Columbia and FLD
- Fits with S-20471  
(Replacement for 05-20763-001 Cap)

 NEWSTAR<sup>®</sup> No.

**S-20397**



## SURGE TANK

### Replacement for

Freightliner Number:  
05-23195-000  
05-23195-001  
Z05-30740-000

- M2 Surge Tank
- Fits with S-20462  
(Replacement for 05-17223-002 Cap)

 NEWSTAR<sup>®</sup> No.

**S-20638**



*Genuine*  
 **NEWSTAR<sup>™</sup>**

# RADIATORS, CHARGE AIR COOLERS AND SURGE TANKS



NEWSTAR<sup>®</sup> No.

**S-18502**

## SURGE TANK

**Replacement for**  
Freightliner Number:  
VML T1555

- FLD



NEWSTAR<sup>®</sup> No.

**S-19974**

## SURGE TANK CAP

**Replacement for**  
Freightliner Number: 05-16271-000

- Century, Columbia and FLD
- Fits S-19603 (Replacement for A05-17076-000)



NEWSTAR<sup>®</sup> No.

**S-20462**

## SURGE TANK CAP

**Replacement for**  
Freightliner Number: 05-17223-002

- M2
- Fits S-20638 (Replacement for Fits 05-23195-000)



# RADIATORS, CHARGE AIR COOLERS AND SURGE TANKS

## SURGE TANK CAP

### Replacement for

Freightliner Number: 05-20763-001

- Century, Columbia and FLD
- Fits S-20397 (Replacement for 05-23045-000 Surge Tank)

 NEWSTAR<sup>®</sup> No.

**S-20471**



## RADIATOR CAP

### Replacement for

Freightliner Number: 05-17223-003

 NEWSTAR<sup>®</sup> No.

**S-20750**



## RADIATOR CAP

### Replacement for

Freightliner Number: 05-17223-000

- Various

 NEWSTAR<sup>®</sup> No.

**S-7625**



## TURBO

### Replacement for

Freightliner Number:  
23528065

- Application: Detroit 60 Engines

 NEWSTAR<sup>®</sup> No.

**S-20996**

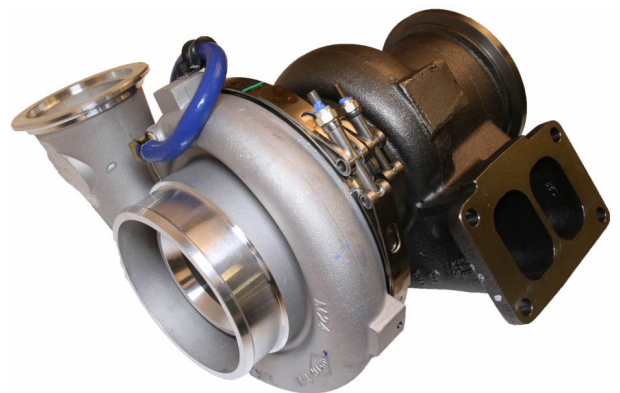

Genuine  
 NEWSTAR<sup>™</sup>

# STEERING PUMPS

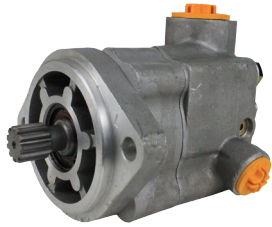

**NEWSTAR<sup>®</sup> No.**

**S-17600**

## POWER STEERING PUMP

### Replacement for

Freightliner Number:	14-12347-000	14-12347-001
	14-12347-002	14-12384-001
	14-12384-003	

- Used with CAT 3406E Engines and TAS85 Steering Gears



**NEWSTAR<sup>®</sup> No.**

**S-D484**

## POWER STEERING PUMP

### Replacement for

Freightliner Number:	14-12464-003
	681 466 50 01

- Century Class, FLD, FLD Military and M2 106
- Cummins NTC and N14 Engines W/ TAS65 and M100 Steering Gears



**NEWSTAR<sup>®</sup> No.**

**S-17552**

## POWER STEERING PUMP

### Replacement for

Freightliner Number:	14-12657-002
----------------------	--------------

- Used with HFB70, TAS40,55,65,85 and M100 Steering Gears



**NEWSTAR<sup>®</sup> No.**

**S-18665**

## POWER STEERING PUMP

### Replacement for

Freightliner Number:	14-13086-000
----------------------	--------------

- Used with HFB70, TAS40,55,65,85 and M100 Steering Gears



**NEWSTAR<sup>®</sup> No.**

**S-19041**

## POWER STEERING PUMP

### Replacement for

Freightliner Number:	14-14323-000
----------------------	--------------

- Cascadia, Century, Columbia, Coronado, FLD and M2



**NEWSTAR<sup>®</sup> No.**

**S-18458**

## POWER STEERING PUMP

### Replacement for

Freightliner Number:	14-14375-000
----------------------	--------------

- Cascadia, Century, Columbia, Coronado, FLD and M2



# STEERING

## PUMPS AND SECTOR SHAFTS

### POWER STEERING PUMP

#### Replacement for

Freightliner Number: 14-14375-002

- FLD
- Sterling with CAT C13

NEWSTAR<sup>®</sup> No.

**S-20762**



### POWER STEERING HOSE

#### Replacement for

Freightliner Number: 14-12872-000

- Multiple Applications

NEWSTAR<sup>®</sup> No.

**S-17550**



### SECTOR SHAFT

#### Replacement for

Freightliner Number: RGB HFB644100A10387

- Application: TAS65 Steering Gear

NEWSTAR<sup>®</sup> No.

**S-4935**



### SECTOR SHAFT

#### Replacement for

Freightliner Number: RHS 18703731

- Application: M100 Steering Gear

NEWSTAR<sup>®</sup> No.

**S-E036**

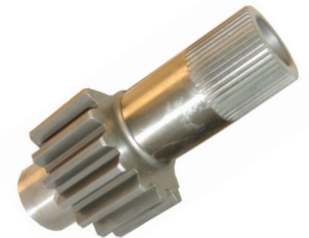

### GASKET

#### Replacement for

Freightliner Number: CUM 154916

- Universal Applications

NEWSTAR<sup>®</sup> No.

**S-C556**



# STEERING KITS



Newstar Number	Replacement for Freightliner Number	Description	Application
----------------	-------------------------------------	-------------	-------------

<b>S-B066</b>	RGT TAS000001	Input Shaft Seal Kit	TAS65
<b>S-11556</b>	RHS 5544861	Input Shaft Seal Kit	M80, 90, 100, 110 Input Seal Kit
<b>S-D837</b>	RHS 2351251K	Input Shaft Seal Kit	Sheppard 392, 492, 592

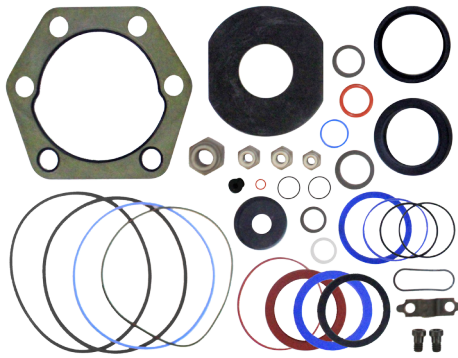

**NEWSTAR No.**

**S-4590**

## MASTER KIT

**Replacement for**  
Freightliner Number:  
RGT HFB640001

- Application: HFB64 Steering Gear

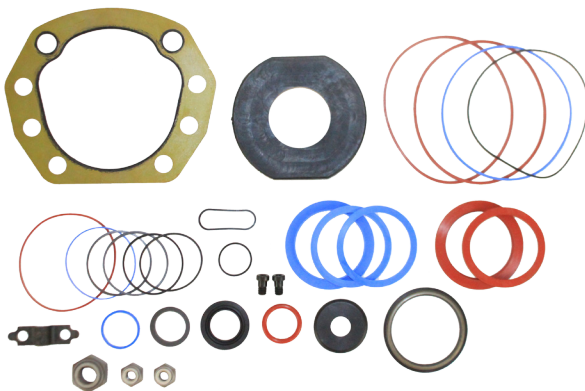

**NEWSTAR No.**

**S-7198**

## MASTER KIT

**Replacement for**  
Freightliner Number:  
RGT HFB700000

- Application: HFB70 Steering Gear



**NEWSTAR No.**

**S-7989**

## MASTER KIT

**Replacement for**  
Freightliner Number:  
VIC 922733

- Application: Vickers V20 Steering Pump

## MASTER KIT

NEWSTAR No.

### Replacement for

Freightliner Number:  
VIC 923548

**S-7988**

- Application: Vickers V10 Steering Pump

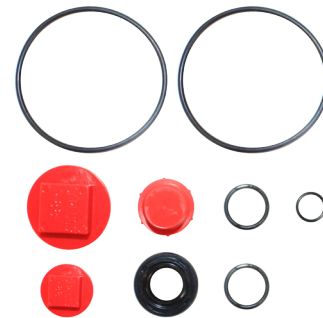

## MASTER KIT

NEWSTAR No.

### Replacement for

Freightliner Number:  
RGT TAS400003

**S-9501**

- Application: TAS40 Steering Gear

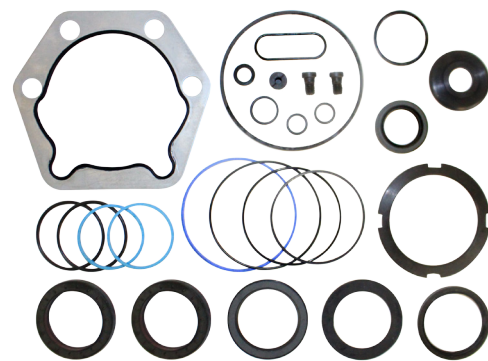

## MASTER KIT

NEWSTAR No.

### Replacement for

Freightliner Number:  
RGT TAS550004

**S-9502**

- Application: TAS55 Steering Gear

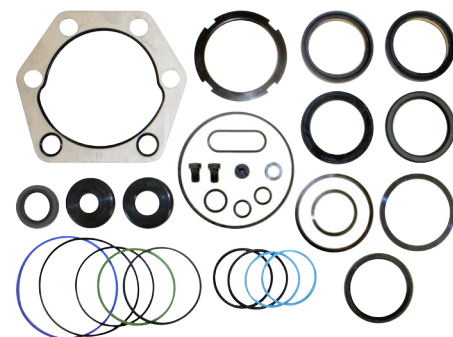

## MASTER KIT

NEWSTAR No.

### Replacement for

Freightliner Number:  
RGT TAS650012

**S-7627**

- Universal Applications
- Application: TAS65 Steering Gear

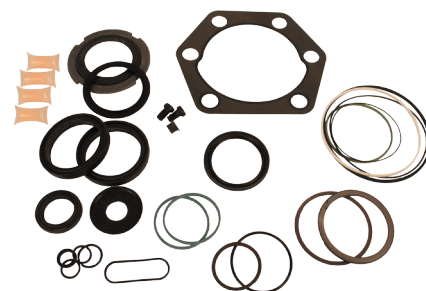

# STEERING KITS

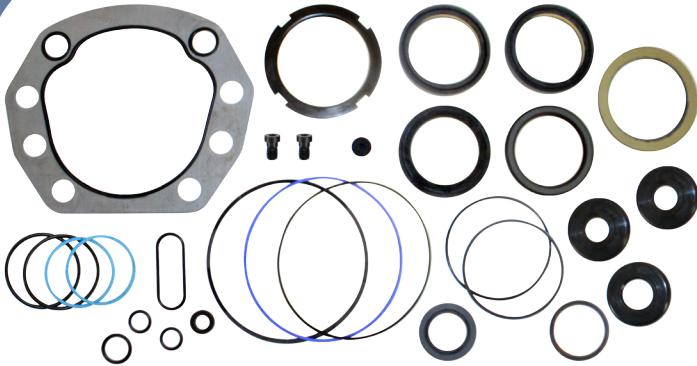

NEWSTAR No.

S-9504

## MASTER KIT

### Replacement for

Freightliner Number:  
RGT TAS850005

- Application: TAS85 Steering Gear

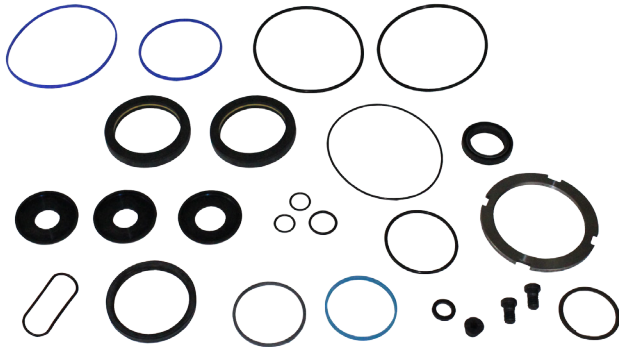

NEWSTAR No.

S-18829

## SECTOR SEAL KIT

### Replacement for

Freightliner Number:  
RGT THP600001

- Application: THP60 Steering Gear



NEWSTAR No.

S-11557

## SECTOR SEAL KIT

### Replacement for

Freightliner Number:  
RHS 5544911

- Application: M90, 100 Steering Gear



NEWSTAR No.

S-11558

## SECTOR SEAL KIT

### Replacement for

Freightliner Number:  
RHS 5545201

- Application: M80 Steering Gear

## MASTER KIT

NEWSTAR<sup>®</sup> No.

### Replacement for

Freightliner Number:  
RHS 5543551

S-D421

- Application: M90 Steering Gear

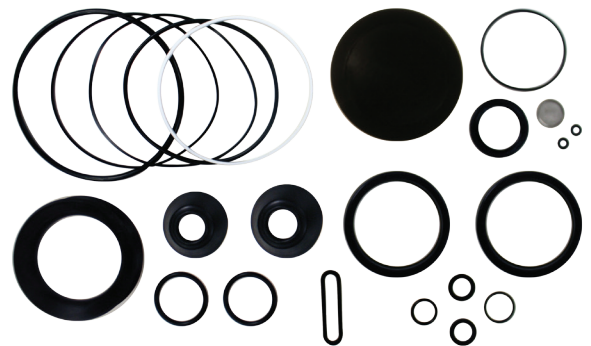

## MASTER KIT

NEWSTAR<sup>®</sup> No.

- Application: M100 Steering Gear
- Freightliner, International, and Volvo Applications

S-17310



## MASTER KIT

NEWSTAR<sup>®</sup> No.

### Replacement for

Freightliner Number:  
RHS 5545221

S-16201

- Application: M100 Steering Gear



## WORM GEAR KIT

NEWSTAR<sup>®</sup> No.

### Replacement for

Freightliner Number:  
RHS 5541421A

S-D694

- Application: M80, 80 and 100 Valve Ring Kit



Genuine  
NEWSTAR<sup>™</sup>

# SUSPENSION

## CAB AIR SPRINGS / MISCELLANEOUS



**NEWSTAR** No.

**S-15566**

### CABIN AIR SPRING

#### Replacement for

Freightliner Number: 1S5-040  
GYR 1S5040

- Columbia, FLD, and Century



**NEWSTAR** No.

**S-20127**

### CABIN AIR SPRING

#### Replacement for

Freightliner Number: 18-52651-000

- Century, Columbia, FLD120SD, Coronado, and Cascadia



**NEWSTAR** No.

**S-20126**

### CABIN AIR SPRING

#### Replacement for

Freightliner Number: 18-29919-000

- Century and Argosy COE 2002 and Earlier

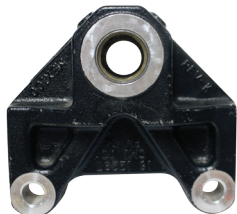

**NEWSTAR** No.

**S-20647**

### BRACKET

#### Replacement for

Freightliner Number: A16-12355-003

- FLD112,120 Conventional/COE



**NEWSTAR** No.

**S-18693**

### BUSHING

#### Replacement for

Freightliner Number: 16-12301-000

- Century, Columbia, and FLD
- Mates with S-B003 (Replacement for 16-12302-000)



**NEWSTAR** No.

**S-15348**

### BUSHING

#### Replacement for

Freightliner Number: 680 322 01 50

- Front End Suspension
- Multiple Freightliner Applications



# SUSPENSION

## CAB MOUNTS / MISCELLANEOUS

### SPRING PIN

#### Replacement for

Freightliner Number: 16-12302-000

- Century, Columbia, and FLD
- Mates with S-18693 (Replacement for 16-12301-000)

NEWSTAR<sup>®</sup> No.

**S-B003**



### SPRING PIN

#### Replacement for

Freightliner Number: 16-12373-000

- FLC, FLD112, 120 Conventional/COE with 4" Spring

NEWSTAR<sup>®</sup> No.

**S-9433**



### CABIN MOUNT

#### Replacement for

Freightliner Number: 18-41005-000

- Columbia and Century

NEWSTAR<sup>®</sup> No.

**S-20642**



### CABIN MOUNT

#### Replacement for

Freightliner Number: A 681 890 00 01

- FLD
- Mates with S-20564 (Replacement for A 681 891 0001)

NEWSTAR<sup>®</sup> No.

**S-20565**



### CABIN MOUNT

#### Replacement for

Freightliner Number: A 681 891 00 01

- FLD
- Mates with S-20565 (Replacement for A 681 890 0001)

NEWSTAR<sup>®</sup> No.

**S-20564**



### CAB MOUNT SWAY BAR BUSHING

#### Replacement for

Freightliner Number: IPC 234761

- FLD

NEWSTAR<sup>®</sup> No.

**S-15349**



# SUSPENSION

## DRAG LINKS



Newstar Number	Replacement for Freightliner Number	Description	Series
<b>S-13715</b>	14-10281-000	Drag Link	FLD - 18.83" Length
<b>S-19938</b>	14-10299-001	Drag Link	FLD - 18.72" Length with M100 Steering Gears
<b>S-13415</b>	14-12098-001	Drag Link	FLD - 28.87" Length with M100 Steering Gears
<b>S-13716</b>	14-12098-005	Drag Link	FLD - 32.03" Length with TAS65 Steering Gears
<b>S-13717</b>	14-12349-000	Drag Link	FLD - 18.83" Length
<b>S-13538</b>	14-12479-000 14-17273-000	Drag Link	Century and Columbia
<b>S-20395</b>	14-17322-000	Drag Link	Century and Columbia





# SUSPENSION KING PIN SETS

## KING PIN SET

NEWSTAR<sup>®</sup> No.

S-C119

### Replacement for

Freightliner Number:  
TDA R201419

- FF981, 982, 986 Axles

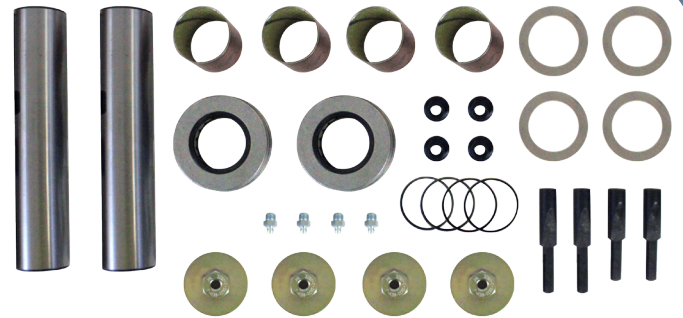

## KING PIN SET

NEWSTAR<sup>®</sup> No.

S-17327

### Replacement for:

Freightliner Number:  
TDA R201475

- Axle Code MFS18  
with E-Z Steer Bushings
- King Pin Size 1.999" x 11.212"



## KING PIN SET

NEWSTAR<sup>®</sup> No.

S-6948

### Replacement for:

Freightliner Number:  
TDA R200195

- Axle Code FF931  
with Bronze Bushings
- King Pin Size 1.7935" x 10.39"



## KING PIN SET

NEWSTAR<sup>®</sup> No.

S-C464

### Replacement for:

Freightliner Number:  
ETN 328344

- Axle Codes E1000I and 1200I  
with E-Z Steer Bushings
- King Pin Size 1.794" x 9.05"



Genuine  
NEWSTAR<sup>™</sup>

# SUSPENSION

## KING PIN SETS



NEWSTAR<sup>™</sup> No.

**S-D562**

### KING PIN SET

**Replacement for:**

Freightliner Number:  
ETN 328342

- Axle Codes E10001 and 12001 with Bronze Bushings
- King Pin Size 1.794" x 9.05"



NEWSTAR<sup>™</sup> No.

**S-6965**

### KING PIN SET

**Replacement for:**

Freightliner Number:  
TDA R201309

- Axle Codes FF931, 952, FG931, 933, 943, 952, 17100, and 17101
- King Pin Size 1.7935" x 10.392"



NEWSTAR<sup>™</sup> No.

**S-8678**

### KING PIN SET

**Replacement for:**

Freightliner Number:  
TDA R201315

- Axle Code F961 with E-Z Steer Bushing
- King Pin Size 1.7935" x 10.392"

## Can't find what you're looking for?

For a complete listing of King Pin Sets, Tie Rod Ends, Torque Rods, Drag Links, and more, check out our website at [www.sandstruck.com](http://www.sandstruck.com).



# SUSPENSION

## BUSHINGS / MISCELLANEOUS

### LEAF SPRING BUSHING

**Replacement for**

Freightliner Number: 16-16412-000

- Century, Columbia, and FLD

 NEWSTAR<sup>®</sup> No.

**S-15468**



### LEAF SPRING BUSHING

**Replacement for**

Freightliner Number: 16-18035-000

- Century, Columbia, and FLD

 NEWSTAR<sup>®</sup> No.

**S-18356**

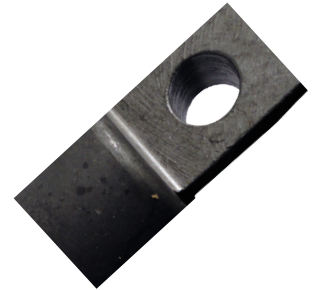

### SHACKLE

**Replacement for**

Freightliner Number: 16-11890-000

- FLD and Century Series

 NEWSTAR<sup>®</sup> No.

**S-A766**



### SHIM KIT

**Replacement for**

Freightliner Number: 16-09040-001

- Consists of 8 Shims
- Front COE and Conventional Cab with 3 1/2 Springs

 NEWSTAR<sup>®</sup> No.

**S-19197**



### SHIM AND WASHER KIT

**Replacement for**

Freightliner Number: 23-09860-012

- Century and Columbia

 NEWSTAR<sup>®</sup> No.

**S-19196**

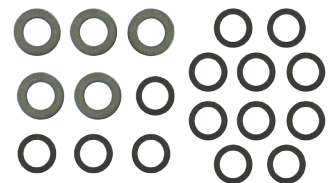

Genuine  
 NEWSTAR<sup>™</sup>

# SUSPENSION

## SHOCKS



NEWSTAR<sup>®</sup> No.

**S-11873**

### SHOCK ABSORBER

#### Replacement for

Freightliner Number: 10-12542-000

- Century with 12M Taper Leaf Suspension
- Model Years 1997-1999



NEWSTAR<sup>®</sup> No.

**S-11800**

### SHOCK ABSORBER

#### Replacement for

Freightliner Number: 10-13021-000

- Century with 12M Taper Leaf Suspension
- Year 2000



NEWSTAR<sup>®</sup> No.

**S-F393**

### SHOCK ABSORBER

#### Replacement for

Freightliner Number: 16-13957-000  
TDA 85724

- Century, Classic, and Columbia with Fas II Rear Air Suspension



NEWSTAR<sup>®</sup> No.

**S-F384**

### SHOCK ABSORBER

#### Replacement for

Freightliner Number: 16-14759-000

- With Hendrickson Suspension



NEWSTAR<sup>®</sup> No.

**S-11804**

### SHOCK ABSORBER

#### Replacement for

Freightliner Number: 18-29846-000

- Legacy Models



# SUSPENSION

## SHOCKS / MISCELLANEOUS

### SHOCK ABSORBER

#### Replacement for

Freightliner Number: 18-32999-000

NEWSTAR<sup>®</sup> No.

S-11801



### SHOCK ABSORBER

#### Replacement for

Freightliner Number: GAB 85047

NEWSTAR<sup>®</sup> No.

S-11798



- Universal

### SPRING HANGER

#### Replacement for

Freightliner Number: 16-14416-000

NEWSTAR<sup>®</sup> No.

S-20321



- FLD

### SPRING PAD

#### Replacement for

Freightliner Number: 680 325 00 09  
A 680 325 00 09

NEWSTAR<sup>®</sup> No.

S-19198



- Century

### SPRING SHACKLE

#### Replacement for

Freightliner Number: A16-16057-000

NEWSTAR<sup>®</sup> No.

S-18489



- Sterling

### SWAYBAR ISOLATOR KIT

#### Replacement for

Freightliner Number: 16-15496-000

NEWSTAR<sup>®</sup> No.

S-18487



- Sterling

# SUSPENSION

## TIE ROD ENDS AND TORQUE BUSHINGS

S-7357



S-E394



Newstar Number	Replacement for Freightliner Number	Description	Series
<b>S-18491</b>	ABP P6073380810	Tie Rod End	1.06" Offset End- Alliance Axle with Hendrickson Suspension- RH
<b>S-18490</b>	ABP P6073382210	Tie Rod End	1.06" Offset End- Alliance Axle with Hendrickson Suspension- LH
<b>S-8999</b>	ETN 1009009	Tie Rod End	Eaton Dana Axle Model: EFA12F4
<b>S-9000</b>	ETN 1009010	Tie Rod End	Eaton Dana Axle Model: EFA12F4
<b>S-E394</b>	ETN 817018	Tie Rod End	Eaton Dana Front Axles E10001, E12001 and E13201- LH
<b>S-E395</b>	ETN 817019	Tie Rod End	Eaton Dana Front Axles E10001, E12001 and E13201- RH
<b>S-7358</b>	TDA R230068	Tie Rod End	FF921, 931, 932, 941, FA109, 139, 309, 329, 339 Axles- LH
<b>S-7357</b>	TDA R230069	Tie Rod End	FF921, 931, 932, 941, FA109, 139, 309, 329, 339 Axles- RH



**NEWSTAR** No.

**S-19962**

### TORQUE ARM BUSHING

#### Replacement for

Freightliner Number: HDR 44695

- Universal



**NEWSTAR** No.

**S-17611**

### TORQUE ARM BUSHING

#### Replacement for

Freightliner Number: HDR 47691

- Fits on A16-16749-001 and A16-16749-002



**NEWSTAR** No.

**S-19963**

### TORQUE ARM BUSHING

#### Replacement for

Freightliner Number: HDR 44697  
IPC 229610

- Application: Hendrickson Torque Rod Bushing
- Fits Pin Style Torque Rod

# SUSPENSION

## TORQUE RODS AND SHACKLE KITS

### SHACKLE KIT

 NEWSTAR<sup>®</sup> No.

**Replacement for:**  
Freightliner Number:  
FL1100

**S-19194**

- Century and Columbia for 4" Leaf Spring
- Includes 2 Shackles and Spring Pins

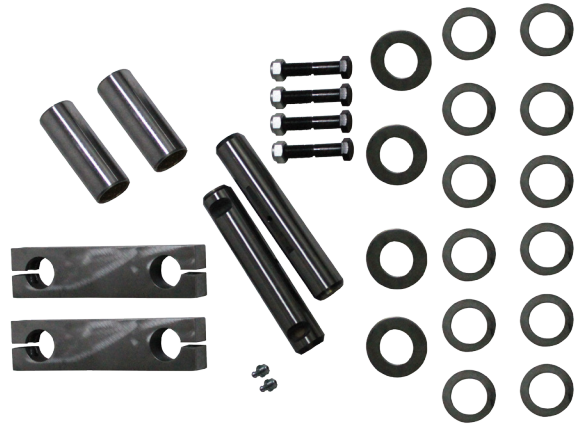

### SHACKLE KIT

 NEWSTAR<sup>®</sup> No.

**Replacement for:**  
Freightliner Number:  
FL1200

**S-19195**

- Century and Columbia for 4" Leaf Spring
- Includes 2 Shackles and Spring Pins

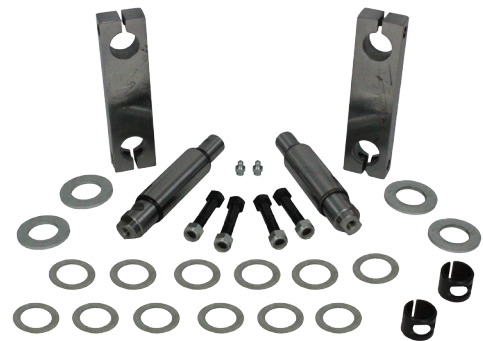

S-20319



S-13373



S-11652

Newstar  
Number

Replacement for  
Freightliner  
Number

Description

Special Features

**S-20319**

16-18972-000

Torque Rod Assembly

Airliner Suspension

**S-13373**

A16-16749-001

Torque Rod Assembly

FLD/Century/Columbia

**S-11652**

A16-16749-002

Torque Rod Assembly

FLD/Century/Columbia

Genuine  
 NEWSTAR<sup>™</sup>

# SUSPENSION

S-13703

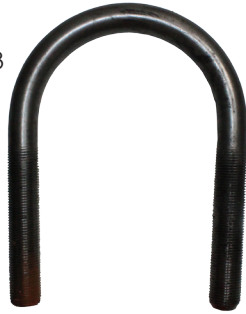

S-19841



S-19809



Newstar Number	Replacement for Freightliner Number	Description	Special Features
<b>S-13703</b>	11-09363-065	U-Bolt	3/4"-16 X 4" X 6.5" Round
<b>S-13829</b>	11-09363-080	U-Bolt	3/4"-16 X 4 X 8" Round
<b>S-B023</b>	11-09624-090	U-Bolt	7/8"-14 X 12.44" Square
<b>S-15526</b>	11-23853-000	U-Bolt	7/8"-14 X 5-5/16 X 14" Square
<b>S-19841</b>	11-23853-001	U-Bolt	7/8"-14 X 5-1.4" X 15-3.8" Semiround
<b>S-19578</b>	16-15435-000	U-Bolt Kit	5/8"-18 X 3-1.2" X 16.75/17.75" Semiround W/ Hardware
<b>S-18913</b>	16-15649-000	U-Bolt Kit	5/8"-18 X 3.06 X 14.5/16" Semiround W/ Hardware
<b>S-18237</b>	16-15649-001	U-Bolt Kit	5/8"-18 X 3.06 X 15.5/17" Semiround W/ Hardware
<b>S-20597</b>	A 680 322 12 25	U-Bolt Kit	3/4"-16 X 7 5/8" Square
<b>S-19809</b>	23-09114-004	U-Bolt Washer	3/4" Grade 8 U-Bolt Washer
<b>S-20898</b>	23-09114-003	U-Bolt Washer	5/8" Grade 8 U-Bolt Washer
<b>S-19808</b>	23-09114-005	U-Bolt Washer	7/8" Grade 8 U-Bolt Washer
<b>S-20897</b>	23-00461-008	High Nut	1"-14 Grade 8 High Nut
<b>S-20893</b>	23-00461-006	High Nut	3/4"-16 Grade 8 High Nut
<b>S-19807</b>	23-00461-005	High Nut	5/8"-18 Grade 8 High Nut
<b>S-20377</b>	23-00461-007	High Nut	7/8"-14 Grade 8 High Nut
<b>S-4433</b>	23-11011-125	Frame Bolt	1/2"-20 X 1-1/4"
<b>S-4435</b>	23-11011-175	Frame Bolt	1/2"-20 X 1-3/4"
<b>S-4436</b>	23-11011-200	Frame Bolt	1/2"-20 X 2"
<b>S-4437</b>	23-11011-225	Frame Bolt	1/2"-20 X 2"-1/4"
<b>S-4505</b>	23-11015-150	Frame Bolt	5/8"-18 X 1-1/2"
<b>S-4733</b>	23-11015-175	Frame Bolt	5/8"-18 X 1-3/4"
<b>S-4734</b>	23-11015-200	Frame Bolt	5/8"-18 X 2"
<b>S-4735</b>	23-11015-225	Frame Bolt	5/8"-18 X 2-1/4"
<b>S-4736</b>	23-11015-250	Frame Bolt	5/8"-18 X 2-1/2"
<b>S-5861</b>	23-11015-275	Frame Bolt	5/8"-18 X 2-3/4"
<b>S-5862</b>	23-11015-300	Frame Bolt	5/8"-18 X 3"
<b>S-4442</b>	23-11015-350	Frame Bolt	5/8"-18 X 3-1/2"
<b>S-9022</b>	23-11015-400	Frame Bolt	5/8"-18 X 4"
<b>S-4737</b>	23-11020-008	Frame Locknut	1/2"-20
<b>S-4738</b>	23-11020-010	Frame Locknut	5/8"-18
<b>S-C635</b>	23-11017-200	Frame Bolt	3/4"-16 X 2"
<b>S-7604</b>	23-11017-250	Frame Bolt	3/4"-16 X 2-1/2"
<b>S-4740</b>	23-11020-012	Frame Locknut	3/4"-16
<b>S-8420</b>	23-11015-450	Frame Bolt	5/8"-18 X 4-1/2"



## AIR COIL

### Replacement for

Freightliner Number: MID 11952

- Universal 15' Set

 NEWSTAR<sup>®</sup> No.

**S-C333**



## HEIGHT CONTROL VALVE

### Replacement for

Freightliner Number: NEW 90054007

- Columbia, FLD and Century

 NEWSTAR<sup>®</sup> No.

**S-8718**



## TRACTOR PROTECTION VALVE

### Replacement for

Freightliner Number: BW 065706

 NEWSTAR<sup>®</sup> No.

**S-16394**



## BRAKE CHAMBER

### Replacement for

Freightliner Number: 3030TS

- Type 30 Tandem Sealed Unit

 NEWSTAR<sup>®</sup> No.

**S-16987**

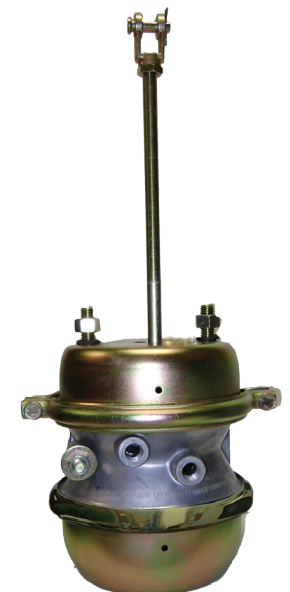

Genuine  
 NEWSTAR<sup>™</sup>



**NEWSTAR** No.

**S-14095**

## FIFTH WHEEL KIT

**Replacement for:**

Freightliner Number:  
FON KTRPR6000L

- Application: Fontaine Fifth Wheel



**NEWSTAR** No.

**S-C322**

## LINKAGE KIT

**Replacement for:**

Freightliner Number:  
HDX 48100225  
HDX SRK168

- Application: Midland/Haldex Leveling Valve



**NEWSTAR** No.

**S-19892**

## MAJOR LH REBUILD KIT

**Replacement for:**

Freightliner Number:  
HLD RK 351 A L

- For Holland XA351 Top Plate



**NEWSTAR** No.

**S-19908**

## TRUNNION KIT

**Replacement for:**

Freightliner Number:  
FON KIT PIN 191

- Application: Fontaine Fifth Wheel



# WIPER ARMS, MOTORS, AND COMPONENTS

## WIPER ARM ASSEMBLY

### Replacement for

Freightliner Number: 4188 30 BWS

- FLD

NEWSTAR<sup>®</sup> No.

S-19443



## WIPER ARM ASSEMBLY

### Replacement for

Freightliner Number: A22-47433-002

- Century

NEWSTAR<sup>®</sup> No.

S-19444



## WIPER ARM ASSEMBLY

### Replacement for

Freightliner Number: A22-51969-000

- Columbia

NEWSTAR<sup>®</sup> No.

S-19665



## WIPER MOTOR

### Replacement for

Freightliner Number: 6685540M025WJ

- FLD

NEWSTAR<sup>®</sup> No.

S-13253



## WIPER ARM NOZZLE

### Replacement for

Freightliner Number: TRI F88171 405

- Columbia
- Used on S-19665 (Replacement for A22-51969-000)

NEWSTAR<sup>®</sup> No.

S-20609



## WIPER ARM NOZZLE ASSEMBLY

### Replacement for

Freightliner Number: SPR GW 254

- FLD
- Use with S-19443 (Replacement for 4188 30 BWS)

NEWSTAR<sup>®</sup> No.

S-21053

Genuine  
**NEWSTAR**<sup>™</sup>

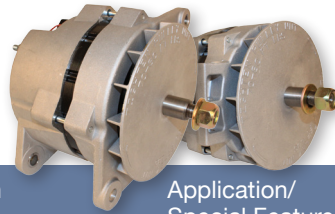
**NEW****REPLACEMENT ELECTRICAL PARTS**

Newstar #	Replacement for Freightliner #	Description	Application/ Special Features
<b>S-21575</b>	110-555HD	Alternator	Replaces 22SI, 12V, 140 AMP, SAE J-180 Swing Mount
<b>S-21576</b>	110-555P	Alternator	Replaces 22SI, 12V, 140 AMP, Pad Mount

**REPLACEMENT CAB & BODY PARTS**

Newstar #	Replacement for Freightliner #	Description	Application/ Special Features
<b>S-21361</b>	03-37017-000	Fuel Cap	Non-locking, Female, 1/4" Turn, 3" Nominal Size
<b>S-21362</b>	03-37017-002	Fuel Cap	Locking with Keys, 1/4" Turn
<b>S-20638</b>	05-23195-000	Surge Tank	Superseded to Z05-30740-000
<b>S-20663</b>	A17-13787-002	Hood Bracket, LH	Columbia
<b>S-20664</b>	A17-13787-003	Hood Bracket, RH	Columbia
<b>S-21788</b>	A17-14930-000	Headlamp Bezel, LH	M2
<b>S-21789</b>	A17-14930-001	Headlamp Bezel, RH	M2
<b>S-19554</b>	A17-15340-004	Hood	Cascadia 120
<b>S-20667</b>	A18-52044-000	Window Regulator, LH	Electronic, Columbia/Century
<b>S-20881</b>	A18-52044-001	Window Regulator, RH	Electronic, Columbia/Century
<b>S-20668</b>	A18-53290-000	Door Hinge Assembly	Century/Columbia
<b>S-20777</b>	A22-59713-001	Mirror Assembly	Columbia M2
<b>S-21679</b>	A22-66565-002	Chrome Mirror, LH	Cascadia
<b>S-21680</b>	A22-66565-003	Chrome Mirror, RH	Cascadia
<b>s-20778</b>	A06-30769-008	Window Switch	Columbia

**REPLACEMENT DRIVETRAIN PARTS**

Newstar #	Replacement for Freightliner #	Description	Application/ Special Features
<b>S-20730</b>	MBA 01-39976-246	Pinion Seal	Alliance/Mercedes Rear
<b>S-20731</b>	MBA 01-39976-646	Input Seal	Alliance/Mercedes Front
<b>S-20732</b>	MBA 01-39976-746	Output Seal	Alliance/Mercedes Front
<b>S-21208</b>	MBA 681 357 06 01	Axle Shaft	Alliance/Mercedes, 38 3/8" Length, 41 Spline, 2.10" Dia.
<b>S-21207</b>	MBA 681 357 07 01	Axle Shaft	Alliance/Mercedes, 43 1/2" Length, 41 Spline, 2.10" Dia.
<b>S-21265</b>	MBA 681-990-02-52	Nut	Alliance/Mercedes, Pinion
<b>S-21254</b>	S-5001	Helical Drive Gear	Alliance/Mercedes, 14 IAD Teeth
<b>S-21255</b>	S-5002	Pinion Drive Gear	Alliance/Mercedes
<b>S-21256</b>	S-5003	Clutch Collar	Alliance/Mercedes, Differential Lock
<b>S-21258</b>	S-5009	Side Gear Input Shaft	Alliance/Mercedes, IAD
<b>S-21259</b>	S-5012	Input Shaft	Alliance/Mercedes
<b>S-21260</b>	S-5014	Power Divider Kit	Alliance/Mercedes, Pinion Gears(4) & Cross Only
<b>S-21452</b>	S-5015	Power Divider Oil Baffle	Alliance/Mercedes
<b>S-21261</b>	S-5016	Gear Set	Alliance, Ratio 3.58 Front & Rear, Standard Diff. Lock
<b>S-21262</b>	S-5017	Case Half	Half-Non Ring Gear Side
<b>S-21270</b>	S-5018	Sliding Clutch	Alliance, IAD
<b>S-21263</b>	S-5019	Gear Set	Alliance, Ratio 3.42 Front & Rear, Standard Diff. Lock
<b>S-21264</b>	S-5020	Differential Gear Kit	Alliance, 46 Spline w/ Diff. Lock, 4 Pinions Consists of: 2 Side Gears, 3-Piece Cross Shaft & Washers
<b>S-13807</b>	23-11015-375	Flange Bolt	

**NEW**



## REPLACEMENT AIR & BRAKE PARTS

Newstar #	Replacement for Freightliner #	Description	Application/ Special Features
<b>S-21233</b>	802078	Disc Pad Set	Bendix Caliper ADB22X, SB6000 FMSI # 8479-D1369
<b>S-21128</b>	ASL0204002619	Guide Bolt Kit	Used w/ 66mm & 73mm, 2 Wheel Brake Hardware Kit
<b>S-20674</b>	CTH 8956K895	Toggle Switch	FLD
<b>S-20675</b>	CTH 8956K913	Toggle Switch	FLD
<b>S-20676</b>	CTH 8956K897	Toggle Switch	FLD
<b>S-20677</b>	FSC 1749-1907	Air Pressure Switch	Columbia, Century, & FLD
<b>S-20678</b>	FSC 1749-2134	Cut-Off Switch	Columbia, Century, & FLD
<b>S-11892</b>	16-1438-000	Leveling Valve	Genuine Barksdale, Multiple Applications



## REPLACEMENT POWER STEERING & ENGINE PARTS

Newstar #	Replacement for Freightliner #	Description	Application/ Special Features
<b>S-20762</b>	14-14375-002	Power Steering Pump	TRW/ROSS, Sterling w/ CAT C13 Engine, Cummins ISX
<b>S-21127</b>	14-14442-020	Power Steering Hose	Cascadia, Columbia, Coronado, FLD, & M2
<b>S-21246</b>	04-17131-009	Exhaust Pipe	Detroit Series 60, Century Class Sleepers
<b>S-21321</b>	04-21166-000	Turbo Pipe, Aluminized	Fits B5.9L Cummins Diesel 2004 & Up w/ 5.9L
<b>S-21787</b>	04-24279-000	Heat Shield Clamp	Cascadia
<b>S-21107</b>	A04-17476-000	Exhaust Pipe	Century & Columbia, 90° Elbow, Decrement Coating 5"
<b>S-20673</b>	BCD 28847 1	Radiator Mount	Columbia & Century
<b>S-21455</b>	BHT U3933001	Radiator	Columbia AN M2, Mercedes Engine
<b>S-21125</b>	DDE 08929388	TRS Sensor	90° 2 Pin Terminal, Includes Bracket & O-Ring Detroit Diesel Series 60 Engines
<b>S-21206</b>	DDE 23528418	Turbo Boost Sensor	Detroit Diesel Series 60 DDEC Engines



## REPLACEMENT CHASSIS PARTS

Newstar #	Replacement for Freightliner #	Description	Application/ Special Features
<b>S-21407</b>	16-15141-000	Sway Bar Isolator	FLD
<b>S-20645</b>	23-12705-001	Isolator Nut	Columbia, 1/4-20, Grip 0.08/0.45, QTY Pk of 10, Fits S-18650
<b>S-20261</b>	A16-12614-001	Leaf Spring	Front Taper, 14K w/ Bushing for Hendrickson Suspension
<b>S-20262</b>	A16-13977-000	Leaf Spring	14K Parabolic Spring for Hendrickson Suspension
<b>S-20263</b>	A16-15293-000	Leaf Spring	Front Taper, FL, CL120 w/ 14.6K
<b>S-21423</b>	89412	Shock Absorber	Gas SLX Adjust. Rear, FLD, FLC, COE w/ convoluted Air Suspension
<b>S-20334</b>	5541801	Steering Gear Kit	All M Series Steering Gears, Rotary Valve Seal Kit
<b>S-21095</b>	XB-00112	Rubber Cushion	2 Req., Holland Wheel Pivot Bushing



## REPLACEMENT HVAC PARTS

Newstar #	Replacement for Freightliner #	Description	Application/ Special Features
<b>S-21076</b>	A22-66700-000	Receiver Dryer	Cascadia w/ Detroit Diesel 13 & 15L, EPA10 Engines
<b>S-21463</b>	A22-66842-000	A/C Condenser	M2, Sterling Acterra
<b>S-19245</b>	ABP N83 303123T	A/C Condenser Clutch	Columbia, Century, FLD & M2, York/Tecumseh Style
<b>S-21389</b>	ABP N83 318179	Binary Switch	Columbia, FLD, Century & FL
<b>S-21462</b>	ABP N83-319624	A/C Receiver Dryer	FLD, Classic XL
<b>S-21358</b>	FLF FRE1020 0001	Turbo Hose	Multiple Applications, Cold Air Return 4" x 6.5" CAC

# INTERCHANGE INDEX

## REPLACEMENT FOR FREIGHTLINER

Newstar Number	Replacement Number	Page
S-18153	204	20
S-A043	493	20
S-18410	496	20
S-A044	497	20
S-A045	563	20
S-A046	567	20
S-C525	3720	20
S-C526	3782	20
S-D995	3920	13, 20
S-18995	4417	74
S-5501	8677	56
S-18997	9220	20
S-18998	9278	20
S-5761	12815	56, 57
S-F450	14287	20
S-4596	14750	56
S-9063	16980	56
S-4312	20550	56
S-C024	21355	20
S-C025	21356	20
S-A047	29630	20
S-A048	29675	20
S-10459	31520	20
S-A049	31597	20
S-A050	47820	20
S-A051	47890	20
S-15332	52400	20
S-18129	52618	20
S-A053	55437	20
S-6654	72487	20
S-A018	81504	56
S-7440	85533	56
S-B039	85535	56
S-7667	107276	13, 14
S-F028	127545	20
S-B140	127591	20
S-B141	127592	20
S-F022	216220	15
S-12100	216221	15
S-7205	415009	20
S-8604	415146	20
S-20327	805096	13, 14, 20
S-20328	805097	13, 14, 20
S-20886	3680922	54
S-C026	4300828	20
S-C027	4300902	20
S-13750	4301855	20
S-C029	4302074	20
S-19859	4303031	20
S-C031	4304080	20
S-18573	4304599	20
S-16421	5566505	56
S-10233	5566507	20
S-19649	5566508	20
S-F531	5566510	20
S-18718	8929102	65
S-20885	23514177	54
S-18720	23516322	65
S-18719	23522279	65
S-20996	23528065	87
S-19888	01-23132-000	81
S-15418	01-23415-004	64
S-15345	01-23415-046	64
S-15533	01-23415-053	64
S-15441	01-23415-061	64
S-17542	01-23415-080	64
S-17544	01-23415-093	64
S-15421	01-23683-003	64

## REPLACEMENT FOR FREIGHTLINER

Newstar Number	Replacement Number	Page
S-15435	01-23683-004	64
S-17476	01-24196-010	64
S-15414	01-24894-000	64
S-17473	01-24894-004	64
S-17460	01-26709-007	64
S-15423	01-26709-008	64
S-15424	01-26709-009	64
S-17505	01-26709-018	64
S-15425	01-27086-003	64
S-15425	01-27086-004	64
S-15426	01-27110-013	64
S-17509	01-27110-022	64
S-15427	01-27110-023	64
S-17517	01-27110-038	64
S-17544	01-27110-059	64
S-15428	01-27116-004	64
S-15411	01-27116-006	64
S-15430	01-27198-001	64
S-15428	01-28330-003	64
S-15431	01-29730-115	64
S-15432	01-29866-094	64
S-19955	01-31241-000	81
S-19954	01-31242-000	81
S-3347	02-09174-001	55
S-19164	02-09788-007	55
S-19163	02-12467-004	55
S-20225	02-12467-007	55
S-17517	02-23415-053	64
S-18857	03-27310-001	47
S-20394	04-19919-000	72
S-18825	04-21421-000	72
S-20902	04-22338-000	72
S-19782	05-16070-000	84
S-19974	05-16271-000	86
S-11398	05-16366-004	83
S-7625	05-17223-000	87
S-20462	05-17223-002	86
S-20750	05-17223-003	87
S-20471	05-20763-001	87
S-20397	05-23045-000	85
S-20397	05-23045-001	85
S-20638	05-23195-000	85
S-20638	05-23195-001	85
S-20712	05-29617-003	83
S-20586	05-29617-005	83
S-18497	06-26989-000	69
S-18488	06-30361-000	62
S-18645	06-32242-002	43
S-18646	06-32242-003	43
S-11873	10-12542-000	100
S-11800	10-13021-000	100
S-13703	11-09363-065	104
S-13829	11-09363-080	104
S-B023	11-09624-090	104
S-19817	11-14418-000	18
S-15526	11-23853-000	104
S-19841	11-23853-001	104
S-A001	118L	20
S-17595	119L	20
S-A018	1212SLV	20
S-A018	1228-G-1203	57
S-A020	1310L	20
S-C034	1310SLV	21
S-13221	1311L	21
S-13715	14-10281-000	96
S-19938	14-10299-001	96
S-13415	14-12098-001	96
S-13716	14-12098-005	96

## REPLACEMENT FOR FREIGHTLINER

Newstar Number	Replacement Number	Page
S-17600	14-12347-000	88
S-17600	14-12347-001	88
S-17600	14-12347-002	88
S-13717	14-12349-000	96
S-17600	14-12384-001	88
S-17600	14-12384-003	88
S-D484	14-12464-003	88
S-13538	14-12479-000	96
S-17552	14-12657-002	88
S-17550	14-12872-000	89
S-18665	14-13086-000	88
S-19041	14-14323-000	88
S-18458	14-14375-000	88
S-20762	14-14375-002	89
S-13538	14-17273-000	96
S-20395	14-17322-000	96
S-19197	16-09040-001	99
S-A766	16-11890-000	99
S-18693	16-12301-000	94
S-B003	16-12302-000	95
S-9433	16-12373-000	95
S-F393	16-13957-000	100
S-20321	16-14416-000	101
S-F384	16-14759-000	100
S-19980	16-15215-000	47
S-19578	16-15435-000	104
S-18487	16-15496-000	53, 101
S-18913	16-15649-000	104
S-18237	16-15649-001	104
S-15468	16-16412-000	99
S-18356	16-18035-000	99
S-20319	16-18972-000	103
S-20089	17-12069-001	41
S-19995	17-12127-000	35
S-20616	17-12434-000	39
S-13326	17-12435-000	39
S-13327	17-12435-001	39
S-19253	17-12438-000	39
S-18889	17-13788-000	40
S-20611	17-14781-000	40
S-19521	17-14787-000	32
S-19522	17-14787-001	32
S-18269	173119N	79
S-11804	18-29846-000	100
S-20126	18-29919-000	52, 94
S-11801	18-32999-000	101
S-20642	18-41005-000	48, 95
S-19966	18-45384-000	48
S-20643	18-48225-000	29
S-20644	18-48225-001	29
S-20543	18-51378-000	8
S-20127	18-52651-000	52, 94
S-15566	1S5-040	52, 94
S-18986	21-20112-000	23
S-18985	21-20112-001	23
S-18987	21-20113-003	23
S-20386	21-26020-006	23
S-20386	21-26020-011	23
S-19813	21-26021-004	24
S-19814	21-26021-005	24
S-19813	21-26021-006	24
S-19814	21-26021-007	24
S-20350	21-26517-000	25
S-20350	21-26517-000F	25
S-20349	21-26517-001	25
S-20349	21-26517-001F	25
S-20154	21-26684-000	24
S-20155	21-26684-001	24

# INTERCHANGE INDEX

## REPLACEMENT FOR FREIGHTLINER

Newstar Number	Replacement Number	Page
S-20359	21-28177-001	25
S-20358	21-28177-001C	25
S-A004	211B	21
S-16264	22-32466-001	75
S-18647	22-37670-000	26
S-18648	22-37670-001	26
S-11405	22-42084-000	75
S-11405	22-42084-002	75
S-20461	22-51296-000	79
S-20713	22-54495-000	29
S-19807	23-00461-005	104
S-20893	23-00461-006	104
S-20377	23-00461-007	104
S-20897	23-00461-008	104
S-20898	23-09114-003	104
S-19809	23-09114-004	104
S-19808	23-09114-005	104
S-19196	23-09860-012	99
S-11896	23-10001-037	64
S-15344	23-10001-089	64
S-4433	23-11011-125	104
S-4435	23-11011-175	104
S-8420	23-11015-450	104
S-4436	23-11011-200	104
S-4437	23-11011-225	104
S-4505	23-11015-150	104
S-4733	23-11015-175	104
S-4734	23-11015-200	104
S-4735	23-11015-225	104
S-4736	23-11015-250	104
S-5861	23-11015-275	104
S-5862	23-11015-300	104
S-4442	23-11015-350	104
S-9022	23-11015-400	104
S-C635	23-11017-200	104
S-7604	23-11017-250	104
S-4737	23-11020-008	104
S-4738	23-11020-010	104
S-4740	23-11020-012	104
S-20530	23-12201-250	82
S-20224	23-12485-250	82
S-20645	23-12705-001	35
S-19815	23-12891-175	59
S-19798	23-13201-000	79
S-19526	23-13202-000	79
S-19799	23-13205-000	79
S-19740	23-13265-001	70
S-16987	3030TS	11, 105
S-11398	310011T	83
S-12006	3105K1155	57
S-20539	32017X	13, 14, 21
S-20521	32022X	13, 14, 21
S-7440	3296-Q-1239	57
S-7199	35949N	21
S-4710	405-367-C	21
S-19443	4188 30 BWS	107
S-18727	5104114AA	75
S-A052	55200C	21
S-18130	55206C	21
S-11512	55212C	21
S-16461	552A	21
S-13793	555S	21
S-A305	592A	21
S-A306	594A	21
S-13253	6685540M025WJ	107
S-15348	680 322 01 50	94
S-19198	680 325 00 09	101
S-12069	680 545 01 24	49

## REPLACEMENT FOR FREIGHTLINER

Newstar Number	Replacement Number	Page
S-19597	681 291 00 82	55
S-D484	681 466 50 01	88
S-14111	681 544 01 03	42
S-A054	72200C	21
S-A055	72212C	21
S-A650	72218C	21
S-A056	72225C	21
S-20597	A 680 322 12 25	104
S-19198	A 680 325 00 09	101
S-12069	A 680 545 01 24	49
S-18814	A 680 697 00 98	30
S-20526	A 680 880 01 60	40
S-19233	A 680 881 0001	26
S-19234	A 680 881 0101	26
S-19597	A 681 291 00 82	55
S-20056	A 681 544 04 03	43
S-20057	A 681 544 05 03	43
S-20670	A 681 721 02 K0	47
S-20565	A 681 890 00 01	48, 95
S-20564	A 681 891 00 01	48, 95
S-A720	A-1205-G-2425	21
S-B435	A-1205-N-2588	21
S-E014	A-1205-P-1914	21
S-A630	A-1205-P-2590	21
S-A941	A-1205-Q-2591	21
S-A942	A-1205-R-2592	21
S-16394	A-1205-Y-1897	21
S-A906	A01-16025-006	65
S-18883	A02-12321-005	53
S-18883	A02-12765-002	53
S-18883	A02-13110-002	53
S-19593	A03-28631-002	47
S-19593	A03-38910-000	47
S-11398	A05-16366-004	83
S-20537	A06-20711-000	43
S-20538	A06-20711-001	43
S-19772	A06-20738-000	45
S-19773	A06-20738-001	45
S-20646	A06-21643-000	45
S-20596	A06-22743-002	49
S-18706	A06-26631-000	63, 69
S-20778	A06-30769-008	31, 47
S-20022	A06-44025-000	49
S-19774	A06-75732-003	44
S-19775	A06-75732-004	44
S-19777	A06-75737-004	44
S-19778	A06-75737-005	44
S-19894	A06-75742-000	45
S-12068	A14-13495-000	49
S-18302	A14-13495-005	49
S-20647	A16-12355-003	94
S-18489	A16-16057-000	101
S-13373	A16-16749-001	103
S-11652	A16-16749-002	103
S-13329	A17-10464-001	39
S-11940	A17-12081-000	38
S-11941	A17-12082-000	38
S-19997	A17-12082-002	38
S-13326	A17-12435-000	39
S-13327	A17-12435-001	39
S-18204	A17-12442-002	36
S-18204	A17-12443-000	36
S-18207	A17-12622-007	32
S-18209	A17-12623-014	33
S-18894	A17-12792-005	36
S-20392	A17-12934-000	33
S-19993	A17-12994-002	41
S-19994	A17-12994-003	41

## REPLACEMENT FOR FREIGHTLINER

Newstar Number	Replacement Number	Page
S-18893	A17-13534-000	40
S-20663	A17-13787-002	38
S-20664	A17-13787-003	38
S-18894	A17-14024-009	36
S-18217	A17-14768-000	33
S-18894	A17-14774-004	36
S-18894	A17-14774-009	36
S-19521	A17-14787-000	32
S-19522	A17-14787-001	32
S-18206	A17-15092-002	36
S-18651	A17-15192-005	34
S-18649	A17-15251-000	34
S-18650	A17-15251-002	34
S-18650	A17-15251-003	34
S-18206	A17-15420-000	36
S-19090	A17-15457-002	37
S-19090	A17-15459-002	37
S-19251	A17-15553-000	40
S-19252	A17-15553-001	40
S-19106	A17-15624-003	35
S-19110	A17-16035-000	37
S-18651	A17-16132-001	34
S-18651	A17-16132-004	34
S-18205	A17-16515-002	37
S-19106	A17-19112-000	35
S-20665	A17-19230-000	41
S-18895	A18-18557-002	29
S-18808	A18-27783-000	29
S-18809	A18-27783-001	29
S-18815	A18-35381-000	28
S-18816	A18-35381-001	28
S-18817	A18-42228-000	28
S-18818	A18-42228-001	28
S-19117	A18-42228-002	28
S-19118	A18-42228-003	28
S-19838	A18-43367-000	30
S-19839	A18-43367-001	30
S-19912	A18-44466-000	30
S-20667	A18-52044-000	31
S-20881	A18-52044-001	31
S-20668	A18-53290-000	30
S-19562	A21-26500-040	27
S-20628	A22-42390-005	69
S-19444	A22-47433-002	107
S-19665	A22-51969-000	107
S-20404	A22-54198-000	27
S-20405	A22-54198-001	27
S-18504	A22-57423-000	27
S-18505	A22-57423-001	27
S-20648	A22-58516-001	46
S-20649	A22-59615-015	46
S-20650	A22-59615-016	46
S-20777	A22-59713-001	46
S-20856	A22-63159-041	29
S-20393	A22-63992-000	78
S-20393	A22-63992-001	78
S-19610	A22-65663-000	76
S-19734	A22-65847-000	35
S-19610	A22-66824-000	76
S-19639	A22-66825-000	75
S-19610	A22-66839-000	76
S-19639	A22-66840-000	75
S-19610	A22-67125-000	76
S-19639	A22-67126-000	75
S-20629	A22-68359-000	69
S-E918	A2892	21
S-20739	A3071	21
S-18924	A4965	77

# INTERCHANGE INDEX

## REPLACEMENT FOR FREIGHTLINER

Newstar Number	Replacement Number	Page
S-B339	ABP N35 30PLS	71
S-C110	ABP N35 35PLA	71
S-4332	ABP N35 400UBRS	71
S-7687	ABP N35 50PLA	71
S-8476	ABP N35 40PLA	71
S-D424	ABP N35 40PLS	71
S-4333	ABP N35 500UBRS	71
S-18721	ABP N83 301017	73
S-B398	ABP N83 301137	73
S-11455	ABP N83 301527	73
S-17955	ABP N83 304061T	74
S-19249	ABP N83 304201T	74
S-18995	ABP N83 304543	74
S-18824	ABP N83 308011	77
S-19357	ABP N83 308375	77
S-18725	ABP N83 319614	78
S-18724	ABP N83 319744	78
S-18491	ABP P6073380810	102
S-18490	ABP P6073382210	102
S-19498	ARS BVC3A	79
S-18633	ASL 4150080	12
S-20336	ASL 4151751	12
S-19292	BCD 27330 1	67
S-20672	BCD 27330 2	67
S-19293	BCD 27477 2	67
S-20314	BCD 27651 2	67
S-20315	BCD 27651 3	67
S-19293	BCD 28805 1	67
S-20673	BCD 28847 1	84
S-19291	BCD 28945 1	68
S-16265	BHT 79465	76
S-16265	BHT 92710	76
S-11397	BHT A6724	83
S-11397	BHT A6725002	83
S-11397	BHT B4763002	83
S-17115	BHT D3521	82
S-17116	BHT D3523	82
S-19956	BHT D3526	81
S-19499	BHT E2108	76
S-19499	BHT P5631001	76
S-18929	BHT U3692001	84
S-11405	BOA 3101211TC	75
S-B398	BOA 80 415 00789	73
S-20458	BOA 803210026900	77
S-20436	BOA 91594	80
S-18958	BOA 91616	80
S-20607	BOA 91619	80
S-18875	BOA 93674	77
S-18728	BOA 93675	80
S-18924	BOA A4965	77
S-18270	BOA D8587	73
S-9414	BRZ B9224-0411 FR U B	71
S-14057	BRZ B9226-0406	71
S-F345	BW 065225	4
S-11844	BW 065625	4
S-16394	BW 065706	8, 105
S-16725	BW 104574	8
S-C428	BW 107216	11
S-A323	BW 109994	4
S-6106	BW 275491	5
S-F496	BW 275491-12	5
S-A535	BW 284358	5
S-14094	BW 298715	12
S-13394	BW 5004188	12
S-A568	BW 5005037	9
S-18044	BW 800333	8
S-11874	BW 800361	5
S-12093	BW 800404	9

## REPLACEMENT FOR FREIGHTLINER

Newstar Number	Replacement Number	Page
S-D810	BW 800405	9
S-16933	BW 800573	9
S-17760	BW K022105	9
S-11844	BX 109493	4
S-20014	CB-1120	85
S-20014	CB1120-3	85
S-A862	CIU500F1	71
S-20674	CTH 8956K895	7, 50
S-20676	CTH 8956K897	7, 50
S-20675	CTH 8956K913	7, 50
S-C556	CUM 154916	89
S-20025	CUM 3078307	61
S-18434	DDE 23505886	63
S-20812	DDE 23514708	66
S-20811	DDE 23515251	66
S-18720	DDE 23516322	65
S-20809	DDE 23520380	66
S-20655	DDE 23522269	65
S-18719	DDE 23522279	65
S-18719	DDE 23539103	65
S-18718	DDE 8929102	65
S-A995	DNM100465	72
S-B068	DNX004478	71
S-4965	DNX004482	71
S-4966	DNX004484	71
S-A910	DNX006202	71
S-D895	DR 1115556	69
S-E226	DR 1990352	62
S-16660	DR 1990428	61
S-E226	DR 1990483	62
S-16660	DR 10461075	61
S-10134	DR 19011176	61
S-E230	DR 19020309	61
S-18268	ESX 120-105112-2	69
S-8999	ETN 1009009	102
S-9000	ETN 1009010	102
S-D562	ETN 328342	98
S-C464	ETN 328344	97
S-E394	ETN 817018	102
S-E395	ETN 817019	102
S-20037	EXO 7AH00038-01-SP	84
S-19194	FL1100	103
S-19195	FL1200	103
S-19908	FON KIT PIN 191	106
S-14095	FON KITRPR6000L	106
S-20677	FSC 1749 1907	7, 50
S-20678	FSC 1749 2134	7, 50
S-C462	FUL A-6909	10, 51
S-C461	FUL A-6913	10, 51
S-C460	FUL A-6915	10, 51
S-9971	FUL K-2468	56
S-11798	GAB 85047	101
S-11672	GAFP107206	55
S-18652	GAFP114238	71
S-19176	GAFP115559	72
S-18494	GAFP116403	72
S-18664	GAFP117693	72
S-10275	GRO-01-4811-77	49
S-13884	GRV 1600	11
S-5116	GRV 1650	10
S-15410	GT4080562DF	64
S-C065	GTD 3222 1	10, 51
S-B888	GUN AS1132	6
S-C299	GUN AS1136	6
S-C300	GUN AS1138	6
S-15566	GYR 1S5040	52, 94
S-F316	H600	8
S-A074	H715311	21

## REPLACEMENT FOR FREIGHTLINER

Newstar Number	Replacement Number	Page
S-A075	H715334	21
S-A076	H715343	21
S-5222	HDC 21215	71
S-19962	HDR 44695	102
S-19963	HDR 44697	102
S-17611	HDR 47691	102
S-C322	HDX 48100225	106
S-C322	HDX SRK168	106
S-18298	HOR 994985	63
S-19892	HLD RK 351 A L	106
S-E002	HM813810	21
S-E003	HM813843	21
S-18856	HUN 68D885	52
S-19963	IPC 229610	102
S-15349	IPC 234761	95
S-A062	JLM104910	21
S-A063	JLM104949	21
S-A072	JLM710910	21
S-A073	JLM710949C	21
S-18133	JLM714110	13, 21
S-18134	JLM714149	13, 21
S-A068	JM511910	21
S-11492	JM511945	13, 21
S-A069	JM511946	21
S-A077	JM716610	22
S-A078	JM716649	22
S-17679	JP10010A	22
S-16045	JP10049	22
S-9836	K-1079	16
S-9613	K-1554	16
S-9614	K-1850	16
S-9599	K-1851	16
S-17177	K-1860	16
S-A573	K-1861	16
S-9601	K-1862	16
S-9602	K-1870	16
S-9598	K-1871	16
S-9608	K-1872	16
S-9600	K-1880	16
S-19159	K-1971	16
S-13514	K-1972	16
S-20842	K-1995	16
S-17060	K-1999	16
S-9053	K-2043	16
S-19316	K-2047	16
S-7663	K-2256	22
S-8474	K-2262	22
S-17052	K-2275	16
S-0948	K-2277	16
S-17061	K-2280	16
S-9600	K-2283	16
S-0750	K-2284	16
S-11446	K-2286	16
S-11447	K-2287	16
S-17053	K-2288	16
S-11837	K-2336	16
S-17054	K-2758	16
S-17055	K-2760	16
S-17056	K-2761	16
S-20843	K-2762	16
S-20844	K-2763	16
S-20804	K-2765	16
S-F489	K-2773	16
S-17057	K-2779	16
S-9596	K-2780	16
S-11448	K-2865	16
S-18444	K-2866	16
S-11449	K-2924	16



# INTERCHANGE INDEX

REPLACEMENT FOR FREIGHTLINER		
Newstar Number	Replacement Number	Page
S-20845	K-2993	16
S-20846	K-2994	16
S-15477	K-3132	16
S-17059	K-3233	16
S-17058	K-3234	16
S-18259	K-3256	16
S-19629	K-3273	16
S-16913	K-3282	16
S-18395	K-3283	16
S-12099	K-3286	16
S-17271	K-3287	17
S-17612	K-3323	17
S-17696	K-3339	17
S-13017	K-3340	17
S-16576	K-3342	17
S-11450	K-3343	17
S-20847	K-3345	17
S-15365	K-3346	17
S-20848	K-3347	17
S-20849	K-3354	17
S-17968	K-3355	17
S-17592	K-3425	17
S-18264	K-3426	17
S-20850	K-3459	17
S-20851	K-3461	17
S-17317	K-3522	17
S-17263	K-3660	17
S-9582	KIT-4000	15
S-9779	KIT-4005	15
S-9705	KIT-4010	15
S-9706	KIT-4025	15
S-9568	KIT-4045	15
S-9570	KIT-4055	15
S-9569	KIT-4065	15
S-9562	KIT-4075	15
S-9561	KIT-4080	15
S-9562	KIT-4105	15
S-20835	KIT-4140	15
S-9557	KIT-4150	15
S-20836	KIT-4220	15
S-9839	KIT-4340	15
S-20837	KIT-4345	15
S-20838	KIT-4350	15
S-11197	KIT-4356	15
S-A575	KIT-4385	15
S-C545	KIT-4390	15
S-9578	KIT-4395	15
S-C546	KIT-4396	15
S-A574	KIT-4400	15
S-C547	KIT-4405	15
S-C548	KIT-4406	15
S-C549	KIT-4415	15
S-F245	KIT-4420	15
S-17325	KIT-4422	15
S-C550	KIT-4423	15
S-C551	KIT-4426	15
S-C552	KIT-4428	15
S-C553	KIT-4435	15
S-20839	KIT-4436	15
S-C554	KIT-4437	15
S-20840	KIT-4440	15
S-18592	KIT-4441	15
S-18593	KIT-4443	15
S-20841	KIT-4450	15
S-17702	KIT-5356	17
S-17355	KIT-5357	17
S-20852	KIT-5358	17
S-20853	KIT-5360	17

REPLACEMENT FOR FREIGHTLINER		
Newstar Number	Replacement Number	Page
S-16966	KIT-5406	17
S-10309	KIT5367	57
S-13443	LM603011	22
S-A071	LM603049	22
S-19127	LN SAZ4201BR	69
S-20014	LOR CB1120 3	85
S-19891	LOR CB220273	84
S-19317	LOR CBA24 650 17	68
S-A797	LOR J17700 5	39
S-19998	LOR J20941 6	68
S-19525	LOR SSB33 10017	68
S-19334	LOR SSB33 10018	68
S-20730	MBA 01-39976-246	14
S-20731	MBA 01-39976-646	13
S-20732	MBA 01-39976-746	13
S-15415	MBT A68199705	64
S-15417	MBT A68199707	64
S-C333	MID 11952	12, 105
S-16265	MOD 1E5864	76
S-17116	MOD 1E6017	82
S-16265	MOD 1E6068	76
S-A024	MR1307EL	22
S-A023	MSN1211REX	22
S-A028	MU1308UM	22
S-19805	MUB1307UM	22
S-13489	MUB7307UM	22
S-8718	NEW 90054007	105
S-18724	PH 088539 00	78
S-17608	POT VF28 15F14 C05	70
S-A859	POT VF4 15F11	70
S-9443	POT VF4 15F21 S01	42, 70
S-B039	R160012	57
S-5222	RAY 001010001	71
S-7537	RAY 10028-006	71
S-4935	RGB HFB644100A10387	89
S-4590	RGT HFB640001	90
S-7198	RGT HFB700000	90
S-B066	RGT TAS000001	90
S-9501	RGT TAS400003	91
S-9502	RGT TAS550004	91
S-7627	RGT TAS650012	91
S-9504	RGT TAS850005	92
S-18829	RGT THP600001	92
S-E036	RHS 18703731	89
S-D837	RHS 2351251K	90
S-D694	RHS 5541421A	93
S-D421	RHS 5543551	93
S-11556	RHS 5544861	90
S-11557	RHS 5544911	92
S-11558	RHS 5545201	92
S-16201	RHS 5545221	93
S-A999	RKR 50PLB	71
S-A914	RKR U50OPL	71
S-A031	RU1570UM	22
S-C632	RU9008UM	22
S-6519	S-1659	56
S-20810	SA A 85920038	66
S-11672	SBN 6305 2RSJSKF	55
S-16421	SBN 63062RS2C3SKF	57
S-18995	SKI 4417	74
S-A859	SOG 8961CR1U0312S	70
S-17608	SOG 898H1CR1U0312S	70
S-19630	SP 071HG100	18
S-7440	SP 105C137	53
S-3347	SP 106C1498	55
S-15475	SP 127200	53
S-B039	SP 127760	53
S-7935	SP 2100842X	58

REPLACEMENT FOR FREIGHTLINER		
Newstar Number	Replacement Number	Page
S-7934	SP 2100881X	58
S-D458	SP 2101301X	58
S-D460	SP 2101401X	58
S-7020	SP 2103911X	58
S-7926	SP 2106611X	58
S-B333	SP 2108751X	58
S-18847	SP 5003323	58
S-21053	SPR GW 254	107
S-B360	STM 343-4009	6
S-B358	STM 343-4024	6
S-B362	STM 343-4075	6
S-B365	STM 359-5990	6
S-E781	STM 359-5995	6
S-F393	TDA 85724	100
S-16980	TDAA1-1205Y-2729	22
S-1980	TDA CB2101211X	58
S-18847	TDA CB210661 1XSA	58
S-13529	TDA CP20RPLS	60
S-13530	TDA CP25RPLS	60
S-7435	TDA CP280X	60
S-19815	TDA CS-C8-20-52	59
S-14654	TDA KIT 1432	18
S-18553	TDA KITRPL2520	59
S-6948	TDA R200195	97
S-6965	TDA R201309	98
S-8678	TDA R201315	98
S-C119	TDA R201419	97
S-17327	TDA R201475	97
S-7358	TDA R230068	102
S-7357	TDA R230069	102
S-7434	TDA R279X	60
S-7435	TDA R280X	60
S-2627	TDA R281X	60
S-6099	TDA R407X	60
S-C472	TDA R674X	60
S-C473	TDA R675X	60
S-C474	TDA R676X	60
S-C475	TDA R677X	60
S-A670	TDA R801079	6
S-19077	TDA R810019	11
S-13728	TDA R955205	4
S-E358	TDA US170X	60
S-E359	TDA US250X	60
S-E129	TDA US90X	60
S-14063	TL 40002Y	42
S-A864	TL 40202R3	42
S-5162	TNS TF0552TT002	42
S-20609	TRI F88171 405	107
S-4356	UTA 1457011	45
S-7989	VIC 922733	90
S-7988	VIC 923548	91
S-18502	VML T1555	86
S-E849	VML T3248	85
S-A038	WJ162116	22
S-20638	Z05-30740-000	85
S-19549	Z18-48818-000	28
S-19550	Z18-48818-020	28

# NEWSTAR™ ADDITIONAL CATALOGS AND INFORMATION



COMPLETE BINDERS AVAILABLE BY REQUEST



POWER STEERING      CHASSIS      AIR & HYDRAULIC      FREIGHTLINER TRUCK      HOODS & GRILLES



MILITARY TRUCK      INTERNATIONAL TRUCK      DRIVELINE      PTO & HYDRAULIC      HVAC

VIEW ONLINE CATALOGS AT :  
[WWW.SANDSTRUCK.COM](http://WWW.SANDSTRUCK.COM)

OR CONTACT US TO RECEIVE OUR CATALOGS IN THE FOLLOWING FORMATS:  
PRINTED CATALOG  
CD-ROM



DRIVE TRAIN      STARTERS & ALTERNATORS      WATER PUMPS      SEVERE DUTY V-BELTS



FOR OVER HALF A CENTURY S & S TRUCK PARTS, INC., THE PARENT COMPANY OF NEWSTAR HAS SUPPLIED REPLACEMENT COMPONENTS FOR MEDIUM AND HEAVY DUTY TRUCKS. WE ARE KNOWN FOR PROVIDING QUALITY PARTS THAT ARE COMPETITIVELY PRICED AND SUPPORTING OUR CUSTOMERS WITH AN EXTREMELY KNOWLEDGEABLE STAFF THAT IS BOTH FRIENDLY AND SERVICE-ORIENTED. AS WE PASS THE DECADE MARK AT OUR CORPORATE FACILITY IN SCHAUMBURG, ILLINOIS, WE STRIVE TO STRENGTHEN OUR SHIPPING LOGISTICS WITH STATE-OF-THE-ART PACKAGING AND MATERIAL HANDLING EQUIPMENT. ADD TO THE EQUATION OUR UNSURPASSED QUALITY CONTROL LABORATORY, OUR ADDITIONAL BRANCH LOCATIONS IN RALEIGH, NC AND ONTARIO, CA, AND OUR 97% ORDER FILL RATE, YOU CAN RELY ON S & S TO PROVIDE THE SERVICE AND PERFORMANCE YOU ARE ENTITLED TO.

## QUALITY CONTROL

OUR COMMITMENT TO QUALITY EXTENDS FROM OUR MANUFACTURING PROCESS TO OUR QUALITY CONTROL LABORATORY (QCL). THE QCL LOCATED AT OUR CORPORATE HEADQUARTERS IN SCHAUMBURG, ILLINOIS CONTAINS THE MOST ADVANCED AND SOPHISTICATED QUALITY INSPECTION EQUIPMENT TO ENSURE THAT NEWSTAR COMPONENTS MEET THE INDUSTRY'S MOST STRINGENT QUALITY STANDARDS.

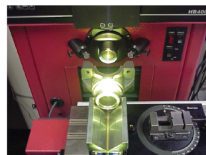

CNC OPTICAL COMPARATOR



CNC GEAR CHECKER



COORDINATE MEASURING MACHINE (CMM)



CUSTOM ENGINEERED FIXTURES

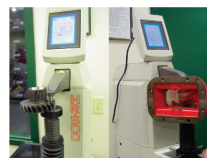

MITUTOYO HR-500 ROCKWELL HARDNESS TESTER



GLEASON UNIVERSAL GEAR TESTER



DUMP PUMP TESTER

## S & S WARRANTY

All Replacement Freightliner Components covered in this catalog are warranted for one (1) year / 100,000 miles from installation, or 18 months after purchase from S & S Truck Parts, Inc., whichever comes first. We warrant all new parts against defective material or workmanship when such parts are used in appropriate applications. We will NOT extend this warranty to parts where failure or damage was caused by misapplication, accident, or abuse.

Unless otherwise stated, authorization from your salesperson is required to initiate any return for warranty. If our examination shows the parts to be defective, we will replace such parts free of charge. This warranty extends solely to replacement of defective parts; we disclaim liability for labor and/or special or consequential damages of any nature.

If it is necessary to return any parts under this warranty, the buyer agrees to wait for settlement of his claim before any deductions are made in payment to S & S. Any expenses incurred without the consent of S & S will be disallowed.



*Genuine*  
**NEWSTAR™**

## 2013 FREIGHTLINER CATALOG

Established in 1954, S&S Truck Parts, Inc. is one of the largest independent suppliers of replacement truck parts in the world. Traditionally known as a drive train gear specialist, S&S has aggressively expanded its product range with the **NEWSTAR** brand.

Under the **NEWSTAR** brand, S&S supplies many of the fastest-moving parts and components in categories including Powertrain, Transmission, Differential, Chassis, Drive Line, Hydraulic, PTO, Power Steering, Air Brake Parts and “captive” vehicle components.

Look for our full line of new product catalogs online at [sandstruck.com/catalogs](http://sandstruck.com/catalogs) and at your authorized distributor.



### UNITED STATES

#### Corporate Headquarters

600 W. Irving Park Road Schaumburg, Illinois 60193  
Order Desk: 847-584-2000 | Toll Free: 844-446-7388  
Fax: 847-584-3000 | Toll Free Fax: 800-621-1558  
Mexico Toll Free: 001-800-727-8373

5320 Departure Drive Raleigh, NC 27616  
Toll Free: 800-334-7058 | Local Fax : 919-872-2836

5200 Ontario Mills Pkwy, Suite 100 Ontario, CA 91764  
Toll Free: 888-621-1553 | Local Fax : 909-481-8555

1401 Valley View Lane, Suite 135 Irving, TX 75061  
Toll Free: 855-621-1553 | Local Fax : 972-986-9333

### CANADA

6460 Kestrel Road Mississauga, Ontario L5T 1Z7  
Local Phone: 905-564-7100 | Toll Free: 800-363-4148  
Local Fax: 905-564-3485

19272 - 96th Ave. Unit #15 Surrey, British Columbia V4N 4C1  
Local Phone: 604-882-2577 | Toll Free: 800-665-4327  
Local Fax: 604-882-3898

176 Creditstone Road, Unit 10 Concord, Ontario L4K 4H7  
Local Phone: 905-761-1399 | Toll Free: 800-363-4148  
Local Fax: 905-761-0698

5318 Finch Ave. East Unit #1-4 Scarborough, Ontario M1S 5G2  
Local Phone : 416-412-7555  
Local Fax : 416-412-7580

