



*Genuine*  
**NEWSTAR™**

**INTERNATIONAL**



**REPLACEMENT PARTS**



## ISO CERTIFICATION

**S&S Truck Parts, Inc.** is certified as an ISO 9001:2008 compliant organization. The certification is accredited by Perry Johnson Registrars (PJR). The certification of compliance with ISO 9001:2008 recognizes that the policies, practices and procedures of our company ensure consistent quality in the product and services we provide our clients. With this certification, our clients can be confident that S&S Truck Parts, Inc. is dedicated to maintaining the highest efficiency and responsiveness in achieving our ultimate goal – guaranteed client satisfaction.



## TRADEMARK ACKNOWLEDGMENTS

S&S Truck Parts, Inc. / NEWSTAR use of the names of original manufacturers, their models, types, part numbers and other descriptive product information is only for the purpose of aiding customers in cross-referencing to the appropriate S&S/NEWSTAR part. The following is a listing, compiled to the best of our knowledge, of Trademarks used in this catalog for the aforementioned purpose.

BENDIX is a trademark of Bendix Commercial Vehicle Systems, LLC  
 CHELSEA is a trademark of Parker Hannifin Corp.  
 DANA® is a trademark of Dana Corp.  
 EATON is a trademark of Eaton Corp.  
 FORD is a trademark of Ford Motor Co.  
 FREIGHTLINER is a trademark of Daimler Trucks No. America, LLC  
 INTERNATIONAL TRUCK is a trademark of Navistar International Corp.  
 IVECO is a trademark of Iveco S.P.A.  
 KENWORTH is a trademark of Paccar, Inc.  
 MERITOR is a trademark of Meritor, Inc.

NEWSTAR is a brand of S&S Truck Parts, Inc.  
 PETERBILT is a trademark of Paccar, Inc.  
 SPL\_X® is a trademark of DANA Corp.  
 SAGINAW is a registered trademark of General Motors Corporation  
 SEALCO is a registered trademark of Sealco Air Controls  
 SPICER is a trademark of DANA Corp.  
 TRW/ROSS is a trademark of TRW Automotive  
 VOLVO is a trademark of AB Volvo Corp.  
 WABCO is a trademark of Wabco GMBH & Co.

BENDIX® and the following alpha-numeric trademarks are owned or licensed by Bendix Commercial Vehicle Systems, LLC. and are used within our catalog for reference and informational purposes only:

AD-4™, AD-9™, AD-IP™, AD-IS®, AD-SP™, BP-R1™, BX-2150™, D-2™, D-2A™, DC-1™, DC-4™, DS-1™, DS-2™, DV-2™, E-3™, E-5™, E-6™, E-7™, E-8P™, E-10™, E-10P™, HV-3™, LP-3™, LQ-2™, LQ-4™, MV-3™, PP-1™, PP-2™, PP-3™, PP-5™, PP-7™, PP-8™, PP-DC™, PR-2™, PR-4™, QR-1™, QR-1C™, R-12™, R-12P™, R-14™, R-6™, R-7™, R-8™, RE-6™, RV-1™, SC-2™, SC-3™, SL-4™, SR-1™, SR-2™, SR-4™, SR-5™, ST-1™, ST-3™, ST-4™, TC-2™, TP-2™, TP-3™, TP-3DC™, TP-5™, TR-2™, TR-3™, TW-1™, TW-4™



All parts supplied are S&S Truck Parts Inc./NEWSTAR. Use of other manufacturer's names, part numbers, or trademarks are solely used for informational/identification purposes.





**AIR & BRAKE 7**

GOVERNORS	7
AIR COMPRESSORS	7
AIR DRYER CARTRIDGES & ASSEMBLIES	10
WHEEL SPEED SENSORS	11
PURGE VALVE KITS	12
BRAKE & DASH VALVES	13
QUICK RELEASE, SAFETY & TRACTOR PROTECTION VALVES	12
BRAKE PADS & CALIPERS	13
EMERGENCY BRAKE SHOES & COMPONENTS	15
ROTORS & COMPONENTS	16
HEATER/THERMOSTAT KITS	17
HUB CAPS & COMPONENTS	18
ADDITIONAL AIR & BRAKE COMPONENTS	18

**CAB & BODY 19**

HOODS & COMPONENTS	19
GRILLES & BEZELS	22
BUMPERS & COMPONENTS	23
FENDER & HOOD EXTENSIONS	24
LAMPS & BEZELS	25
DOOR COMPONENTS	26
WINDOW COMPONENTS	27
MIRRORS	29
FUEL CAPS	31
HANGERS & COMPONENTS	32
HUB COVERS	33
QUARTER FENDERS	33
STEPS & COVERS	34
HORNS	34
ADDITIONAL CAB & BODY COMPONENTS	35

**DRIVELINE 37**

U-JOINTS	37
STRAP KITS & U-BOLT KITS	39
CENTER BEARINGS	40

**DRIVETRAIN 41**

CLUTCH BRAKES & COMPONENTS	41
CLUTCH SHAFTS	42

All parts supplied are S&S Truck Parts Inc./NEWSTAR. Use of other manufacturer's names, part numbers, or trademarks are solely used for informational/identification purposes.

## DRIVETRAIN CNT'D

FLYWHEELS	42
BEARING & SLEEVE ASSEMBLIES	42
DRIVE PINS	42
CLUTCH ASSEMBLIES	43
CLUTCH INSTALLATION KITS	46
ADDITIONAL DRIVETRAIN COMPONENTS	47

## ENGINE 48

RADIATORS & COMPONENTS	48
CHARGE AIR COOLERS	52
TURBO CHARGERS & HOSES	53
TURBO CLAMPS	54
OIL COOLERS	54
EGR COOLERS & COMPONENTS	54
SURGE TANKS & CAPS	55
EXHAUST CLAMPS	56
MUFFLER COMPONENTS	57
FAN CLUTCHES & BELTS	58
INJECTOR SEAL KITS	58
O-RINGS, SEALS & GASKETS	58
ENGINE VALVES & COMPONENTS	58
FUEL PUMPS & COMPONENTS	59
FILTERS	59
OIL CAPS	60
WATERPUMPS	62
MOUNTS	63
CABLES	64
FUEL SENDERS	64
STARTERS	65
ALTERNATORS & COMPONENTS	65
GLOW PLUGS	66
THERMOSTATS	66
HARNESSES	66
ADDITIONAL ENGINE COMPONENTS	67

## HVAC 68

FANS	68
BLOWER MOTORS & WHEELS	68

All parts supplied are S&S Truck Parts Inc./NEWSTAR. Use of other manufacturer's names, part numbers, or trademarks are solely used for informational/identification purposes.







## HVAC CNT'D

RECEIVER DRYERS	70
ACCUMULTOR	70
CONDENSERS	71
CABIN AIR FILTERS	72
COMPRESORS	73
SEALS	74
ACTUATORS	74
EXPANSION VALVES	74
EVAPORATORS & HEATER CORES	75
ADDITIONAL HVAC COMPONENTS	76

## POWER STEERING

**78**

POWER STEERING PUMPS	78
REBUILDING KITS & COMPONENTS	80
SECTOR SHAFTS	83
ADDITIONAL POWER STEERING COMPONENTS	83

## SENSORS

**84**

ICP SENSORS	84
CIRCUIT BREAKERS	84
RELAYS	85
ADDITIONAL SENSORS	86

## SUSPENSION

**87**

AIR BAGS	87
BOLTS	87
U-BOLTS	88
DRAG LINKS	88
KING PIN KITS	89
NUTS	91
SPRING PINS & COMPONENTS	92
TIE ROD ENDS	92
TORQUE RODS & BUSHINGS	94
SHOCK ABSORBERS	95
SHACKLES	95

<b>SWITCHES</b>	<b>96</b>
TURN SIGNAL SWITCHES	96
DIMMER SWITCHES	97
STOP LIGHT SWITCHES	97
IGNITION SWITCHES	98
BACKUP, BRAKE & HEADLAMP SWITCHES	98
LOW PRESSURE SWITCHES	98
BLOWER SWITCHES	99
CRUISE CONTROL SWITCHES	99
SOLENOID SWITCHES	99
OIL SENSORS & GAUGES	100
<b>ADDITIONAL COMPONENTS</b>	<b>101</b>
ADDITIONAL ELECTRICAL COMPONENTS	101



All parts supplied are S&S Truck Parts Inc./NEWSTAR. Use of other manufacturer's names, part numbers, or trademarks are solely used for informational/identification purposes.



## GOVERNORS

### ALL REPLACEMENT GOVERNORS HAVE THE FOLLOWING FEATURES:

- Passed The SAE Standards Endurance Test
- 130 PSI Input Pressure & Delivery, Exhausted in a 4 Second Cycle +200,000 Times



NEWSTAR #:	REPLACES #:	PRODUCT INFORMATION:
<b>S-9977</b>	BX267051 BX267098 BX267100	Replacement for Bendix D-2™ All Ports 1/8" NPT Includes 4 Plugs & MTG. Gasket Pre-set at 125 PSI

NEWSTAR #:	REPLACES #:	PRODUCT INFORMATION:
<b>S-6106</b>	BX275491 ZZKN18530	Replacement for Bendix D-2® All Ports 1/8" NPT Includes 4 Plugs & Mounting Gasket Pre-set at 125 PSI

**S-6106 AVAILABLE IN 12 PACK W/ COUNTER DISPLAY (S-F496)**

## AIR COMPRESSORS-REPLACEMENT FOR BENDIX®

### FEATURES OF ALL REPLACEMENT BENDIX® COMPRESSORS:

- Components are 100% Interchangeable w/ OEM
- New Outright
- No Core Charges
- Newstar Replacement for Bendix® TF750, Upgraded Version of TF550

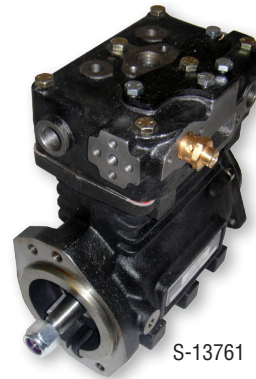

NEWSTAR #:	REPLACES CAT #:	REPLACES BENDIX® #:	REPLACES DDA & VOLVO #:	REPLACES NAVISTAR #:	PRODUCT INFORMATION:
<b>S-13761</b>	104-3823	065273	109552		CAT 3116, 3126, C7 Acert & C9 Acert Applications HT530 Mountings (2004 & Before) Configured to Both CAT & International ITE I-6, NGD & DT466 All w/ Electronic & Mechanical Engines (1995-2007) Over-the-Road Applications Only (Not for Severe Duty)
	106-7851	107980	109626		
	106-7852	107981	109522		
	106-9089	108193	800468		
	109-2996	107979	800469		
	122-1713	108236	5000559	12546827	
	125-9562	108237	109882	15977688	
	164-7557	108730	5003762	3093850	
	164-7558	108194	5004612	8166665	
	4P-0596	109087	5004613	15978946	
	4P-2419	109088	5010279	85102174	
	4P-3596	109110	5005412		
	4P-5435	108987	5005413		
	61-1670	109136	5006716		
	OR-3391	109253	065457		
		109367	065461		
		109111	065601		
		109551			

D-2 is a trademark of Bendix Commercial Vehicle Systems, LLC.

All parts supplied are S&S Truck Parts Inc./NEWSTAR. Use of other manufacturer's names, part numbers, or trademarks are solely used for informational/identification purposes.

## AIR COMPRESSORS-REPLACEMENT FOR BENDIX<sup>®</sup>

### FEATURES OF ALL REPLACEMENT BENDIX<sup>®</sup> COMPRESSORS:

- Components are 100% Interchangeable w/ OEM
- New Outright
- No Core Charges
- Newstar Replacement for Bendix<sup>®</sup> TF750, Upgraded Version of TF550

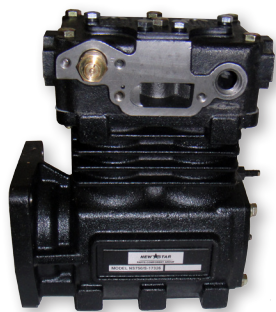

S-17326

NEWSTAR #:	REPLACES CAT #:	REPLACES BENDIX <sup>®</sup> #:		PRODUCT INFORMATION:
S-17326	118-2798	065683	5001788	CAT 3176J, 3406, C10, C12, C15 & C16 Engine Models Includes Safety Valve & Rear Cover Studs
	118-2806	065684	5001789	
	131-6679	109816	5002032	
	131-6680	109824	5002033	
	132-9813	109860	5002652	
	132-9814	109863	5002713	
	133-7032	109864	5002984	
	143-9185	800256	5003228	
	164-7564	800292	5003229	
	215-8055	5001522	5003230	
	OR-3845	5001523	5003234	
	OR-4740	5001533	5003235	
	OR-8253	5001534	5003236	
	OR-8340	5001773	5005419	
OR-8341	5001774	5005478		
S-13753	102-9551	065465	5003231	CAT 3406E, 3176J, C15 & C16 Applications No Rear Cover Studs, Includes Safety Valve
	102-9553	5008609	5003232	
	139-9009	109138	5002983	
	143-9186	109139	5005422	
	164-7566	065466	5005491	
	164-7567	109142	5005421	
	167-1288	109319	5005496	
	61-3909	109141	5005790	
	9Y-6320	109322	5005492	
	OR-8442	800291	5007469	
		109321	5007471	
		5002082	5007468	
		5002826	5007471	
		800725		

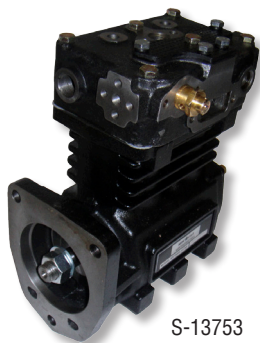

S-13753

### MATING COMPONENTS



GOVERNOR  
(S-6106)



## AIR COMPRESSORS-REPLACEMENT FOR WABCO

### FEATURES OF ALL REPLACEMENT COMPRESSORS:

- Components are 100% interchangeable w/ OEM
- New Outright
- No Core Charges

NEWSTAR #:	REPLACES CUMMINS #:	REPLACES MERITOR #:	REPLACES WABCO #:	PRODUCT INFORMATION:
<b>S-21431</b>	3103413 3681904 3104216R 3101137 3681902 3104216 3104216RX 4952758	ECU9111535100X R9559111535100X	9111535100	NS318 Applications Cummins ISX Engine Models Water Ports: M18 - 1.5 STOR Discharge Ports: M27 - 2.0 STOR Governor Ports: M10 - 1.0 STOR

#### MATING COMPONENTS



**GOVERNOR**  
(S-9977)  
Replaces:  
1055047



**CYLINDER HEAD KIT**  
(S-21432)  
Replaces:  
9111539212  
4936225



**8MM CYLINDER HEAD BOTTOM PLATE**  
(S-21442)



S-21431

NEWSTAR #:	REPLACES CUMMINS #:	REPLACES MERITOR #:	REPLACES WABCO #:	PRODUCT INFORMATION:
<b>S-21435</b>	3944524 3944525 3966522 3944526	ECU9111535300X R9559111535300X	9111535300	NS318 Applications Cummins ISC & ISL Engine Models Water Ports: 3/4" - 16 STOR Discharge Ports: M27 - 2.0 STOR Governor Ports: M10 - 1.0 STOR

#### MATING COMPONENTS

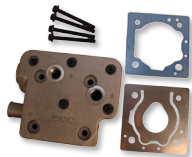

**CYLINDER HEAD** (S-21434)  
Replaces:  
9111539202

ISB, ISC, ISM, M11, N14,  
ISL Engine Models



**GOVERNOR**  
(S-9977)



S-21435

## AIR DRYER CARTRIDGES & ASSEMBLIES

### COMPLEMENTARY COMPONENTS

**AIR DRYER CARTRIDGE**  
S-A323



**AIR DRYER ASSEMBLY**  
S-20738



NEWSTAR #:	REPLACES #:	DESCRIPTION:	PRODUCT INFORMATION:
<b>S-20738</b>	TDAR955300 432-421-009-0 S432-413-024-0 S432-413-024-7 S432-421-048-0 S432-421-048-7	Air Dryer Assembly	Replacement for Meritor SS1200P Requires External Purge Tank
<b>S-A323</b>	432-420-220-2 1-85127-004 432-410-020-2 1-487-434-901 BX5008414	Air Dryer Cartridge	Replacement for Bendix AD-SP™

**AIR DRYER CARTRIDGES ARE NEW/NO CORE CHARGE & INCLUDE SEAL RING KIT**

### COMPLEMENTARY COMPONENTS

**AIR DRYER CARTRIDGE**  
S-A474



**AIR DRYER ASSEMBLY**  
S-F345



NEWSTAR #:	REPLACES #:	DESCRIPTION:	PRODUCT INFORMATION:
<b>S-F345</b>	BX065225 BX109685	Air Dryer Assembly	Replacement for Bendix AD-9™ 12 Volt Complete Replacement Unit Includes Bracket (S-16027)
<b>S-A474</b>	BX107794 BX107796	Air Dryer Cartridge	Replacement for Bendix AD-9™

**AIR DRYER CARTRIDGES ARE NEW/NO CORE CHARGE & INCLUDE SEAL RING KIT**



S-11844

NEWSTAR #:	REPLACES #:	DESCRIPTION:	PRODUCT INFORMATION:
<b>S-11844</b>	BW 109493 BW 065624	Air Dryer Cartridge	Replacement for Bendix AD-IP™
<b>S-A473</b>	BW 103981 BW 104358	Air Dryer Cartridge	Replacement for Bendix AD-4™

**AIR DRYER CARTRIDGES ARE NEW/NO CORE CHARGE & INCLUDE SEAL RING KIT**

AD-9, AD-SP & AD-IP are a trademark of Bendix Commercial Vehicle Systems, LLC.

All parts supplied are S&S Truck Parts Inc./NEWSTAR. Use of other manufacturer's names, part numbers, or trademarks are solely used for informational/identification purposes.



## WHEEL SPEED SENSORS

NEWSTAR #:	REPLACEMENT FOR BENDIX® #:	PRODUCT INFORMATION:
<b>NEW!</b> S-22905	BX801549	Harness Length: 60"/ 1524mm Body Type: 90° Connector Type: DT04
<b>NEW!</b> S-22906	BX801550	Harness Length: 75"/ 1905mm Body Type: 90° Connector Type: DT04
<b>NEW!</b> S-22897	BX801551	Harness Length: 40"/ 1016mm Body Type: 90° Connector Type: DT04
<b>NEW!</b> S-22907	BX801552	Harness Length: 75"/ 1905mm Body Type: Straight Connector Type: DT04
<b>NEW!</b> S-22902	BX801553	Harness Length: 40"/ 1016mm Body Type: Straight Connector Type: DT04



S-22905

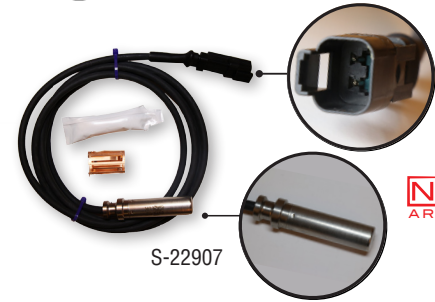

S-22907

Air Dryers

NEWSTAR #:	REPLACEMENT FOR MERITOR WABCO #:	PRODUCT INFORMATION:
<b>NEW!</b> S-22909	TDAR955336	Harness Length: 36"/914mm Body Type: 90° Connector Type: Black Cannon



S-22909

## PURGE VALVE KITS



NEWSTAR #:	REPLACES #:	PRODUCT INFORMATION:
<b>NEW!</b> S-22528	103818	Works w/ Bendix AD-4™ Air Dryers
<b>NEW!</b> S-22527	287053	Works w/ Bendix AD-2™ Air Dryers
<b>S-E278</b>	BX109570 BX109695 BX5004338 BX5004381	Works w/ Works w/ AD-9™ Air Dryers 24 Volt (Grey Cover) Includes Soft Seat Piston Assembly Heater/Thermostat Kit & Purge Housing
<b>S-12093</b>	BX800404 BX065626	Works w/ Bendix AD-IP™ & AD-IS™ Air Dryers
<b>S-D810</b>	BX109569 BX109686 BX800405 BX5004341	Works w/ Bendix AD-9™ Air Dryers 12 Volt White Cover
<b>S-18629</b>	BX109995	Works w/ Bendix AD-SP™ Air Dryers

NEWSTAR #:	REPLACES #:	DESCRIPTION:	PRODUCT INFORMATION:
<b>S-17760</b>	BXK022105	High Boost Purge Valve Assembly Kit	Works w/ Bendix AD-IP™ & AD-IS™

AD-2, AD-4, AD-9, AD-IP, AD-IS & AD-SP are a trademark of Bendix Commercial Vehicle Systems, LLC.

All parts supplied are S&S Truck Parts Inc./NEWSTAR. Use of other manufacturer's names, part numbers, or trademarks are solely used for informational/identification purposes.

## HEATER/THERMOSTAT KITS

NEWSTAR #:	REPLACES #:	PRODUCT INFORMATION:
S-E854	BX109495	Replacement for Bendix AD-SP, AD-IP & AD-IS 12 Volt, Includes Seal Rings & Hardware
S-E855	BX109496	Replacement for Bendix AD-SP, AD-IP & AD-IS 24 Volt, Includes Seal Rings & Hardware
S-C680	BX109578	Replacement for Bendix AD-9 Includes Seal Rings & Hardware 12 Volt (White Cover)
S-E277	BX109579	Replacement for Bendix AD-9 Includes Seal Rings & Hardware 24 Volt (Grey Cover)



## BRAKE VALVES

NEWSTAR #:	REPLACES #:	DESCRIPTION:	PRODUCT INFORMATION:
S-11201	SN4017A BX275747	Brake Valve Treadle Assembly	Fits All Foot Valves Except Bendix E-7™ & E-5™
S-C446	286880 BX286880	Brake Valve	Replacement For Bendix E-6™ w/ Treadle Assembly



NEWSTAR #:	REPLACES #:	DESCRIPTION:	PRODUCT INFORMATION:
S-4771	BX286171	Brake Valve	Replacement for Bendix E-6™ 3/8" NPT supply ports (4) 3/8" NPT delivery ports (4) Dual circuit valve

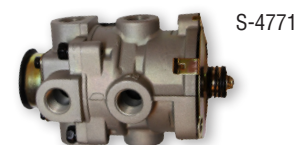

## DASH VALVES

NEWSTAR #:	REPLACES #:	PRODUCT INFORMATION:
S-16988	BX065157 BX800516 1605095C91	Replacement for Bendix MV-3™ Type I Plate (Recessed) w/ .275" Open Mounting Holes (4)
S-11528	ZZKN-20611	Replacement for Midland 1/4" - 20 Threads (4) in Mounting Holes
S-11529	ZZKN-20615	Replacement for Midland 1/4" Mounting Holes (4) w/out Threads
S-16929	BX800257	Replacement for Bendix MV-3™ Type 1 Plate (Recessed) 9/32" Open Mounting Holes P-T-C Fittings in All Ports
S-16933	BX800573 2041137C91	Replacement for Bendix MV-3™ Type 1 Plate (Recessed) 1/4" - 20 Threads (4) in Mounting Holes



E-5, E-6, E-7 & MV-3 are a trademark of Bendix Commercial Vehicle Systems, LLC.

All parts supplied are S&S Truck Parts Inc./NEWSTAR. Use of other manufacturer's names, part numbers, or trademarks are solely used for informational/identification purposes.

## QUICK RELEASE VALVES



NEWSTAR #:	REPLACES #:	PRODUCT INFORMATION:
<b>S-4922</b>	BX229859 BX065212 BX288251	Replacement for Bendix QR-1 NPT Supply: 3/8" NPT Delivery: 3/8"
<b>S-8328</b>	BX229860 ZZKN32011	Replacement for Bendix QR-1 NPT Supply: 1/2" NPT Delivery: 3/8"
<b>S-9749</b>	BX289714	Replacement for Bendix QR-1C NPT Supply: 1/4" NPT Delivery (2): 3/8" NPT Balance: 1/4"

## SAFETY VALVES

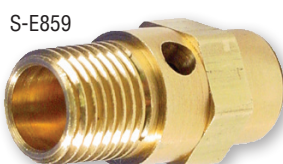

NEWSTAR #:	REPLACES #:	PRODUCT INFORMATION:
<b>S-E859</b>	BX800350	Replacement for Bendix ST-4™ 1/4" NPT Low Profile for Air Dryers Preset at 175 PSI

## TRACTOR PROTECTION VALVES

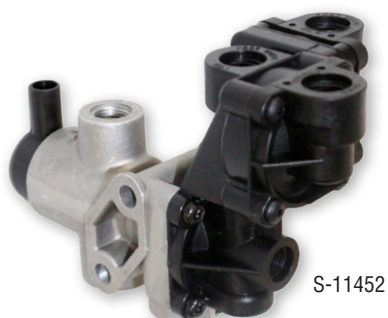

NEWSTAR #:	REPLACES #:	PRODUCT INFORMATION:
<b>S-11452</b>	ZZKN34110 ZZKN34111	NPT Tractor Emergency Port: 3/8" NPT Foot Valve #1 & #2 Ports: 3/8" NPT Hand Control Port: 3/8" NPT Stop LAMP Switch #1 Port: 1/4" NPT Trailer Emergency Port: 1 1/2" NPT Trailer Service Port: 1/2"



QR-1, QR-1C & ST-4 are a trademark of Bendix Commercial Vehicle Systems, LLC.

All parts supplied are S&S Truck Parts Inc./NEWSTAR. Use of other manufacturer's names, part numbers, or trademarks are solely used for informational/identification purposes.

**BRAKE PADS & CALIPERS**



**COMPLEMENTARY COMPONENTS**



NEWSTAR #:	REPLACES #:	DESCRIPTION:	PRODUCT INFORMATION:
<b>S-A782</b>	1658443C91 BX55250	Twin Piston Caliper	S Series & 4000 Series Medium Duty 1700-1800 Flat Back Cows (1981-1988) 3400-3800 Flat Back Cows (1997 & Before) 3600 & 3800 School Bus Series (1997 & Up)  3900 & FC School Bus Series (1997 & Before)  Amtran FE (1999), Genesis/FC & RE School Bus Series (1999 & Before)  Dimensions: 2 7/8"
<b>S-E738</b>	990953C93 FPD225HD	Disc Pad Set	—
<b>S-D418</b>	990956C91 BXH5635	Caliper Key Kit	—
<b>S-E585</b>	254468C1 571250C1 BX94010	Caliper Bleeder Screw	Dimensions: 7/16" - 24

**COMPLEMENTARY COMPONENTS**



NEWSTAR #:	REPLACES #:	DESCRIPTION:	PRODUCT INFORMATION:
<b>S-10130</b>	BX55849 2501839C91 2509253C91 2593418C91	Twin Piston Caliper	4000 Series 3000 School Bus Series (1997 & Up)  3000 IC Integrated School Bus Series (1997 & Before)  3600 & 3800 School Bus Series (1997 & Up)  Dimensions: 2 7/8"
<b>S-13997</b>	2501842C91 ZJCMKD786A 2596037C91	Disc Pad Set	—
<b>S-21128</b>	2509252C92	Caliper Pin Kit	2 Wheel Brake Hardware Kit Bosch Slide Pin Design Works w/ 66 mm & 73 mm Brake Calipers
<b>S-E585</b>	254468C1 571250C1 BX94010	Caliper Bleeder Screw	Dimensions: 7/16" - 24



All parts supplied are S&S Truck Parts Inc./NEWSTAR. Use of other manufacturer's names, part numbers, or trademarks are solely used for informational/identification purposes.



## BRAKE PADS & CALIPERS



### COMPLEMENTARY COMPONENTS



NEWSTAR #:	REPLACES #:	DESCRIPTION:	PRODUCT INFORMATION:
<b>S-10131</b>	BX55850 2501838C91 2509254C91 2593419C91	Twin Piston Caliper	4000 Series 3000 IC & 3000 RE (1999 & Up) 3000 FE School Bus Series (1997 & Up)  3600 & 3800 School Bus Series (1997 & Before)  Amtran FE Series (1999) Amtran Genesis/FC/RE Series (1999 & Before) Dimensions: 2 <sup>7</sup> / <sub>8</sub> "
<b>S-13998</b>	2501841C91 BXMKD786 ZJCMKD786	Disc Pad Set	—
<b>S-21128</b>	2509252C92	Caliper Pin Kit	2 Wheel Brake Hardware Kit Bosch Slide Pin Design Works w/ 66 mm & 73 mm Brake Calipers
<b>S-E585</b>	254468C1 571250C1 BX94010	Caliper Bleeder Screw	Dimensions: <sup>7</sup> / <sub>16</sub> " - 24

### COMPLEMENTARY COMPONENTS



NEWSTAR #:	REPLACES #:	DESCRIPTION:	PRODUCT INFORMATION:
<b>S-A917</b>	1669311C91 BX55314 1669312C91 BX55245 582024C91	Twin Piston Caliper	4000 & S Series Medium Duty 1700 & 1800 Flat Cowls (1981-1988) 3000 School Bus Chassis (1997)  3400-3800 Flat Back Cowls (1997 & Before) 3600 & 3800 School Bus Series (1997 & Up)  3900 School Bus Series (1997 & Before)  Dimensions: 2 <sup>39</sup> / <sub>64</sub> "
<b>S-4252</b>	582028C93 990952C93	Disc Pad Set	—
<b>S-E585</b>	254468C1 571250C1 BX94010	Caliper Bleeder Screw	Dimensions: <sup>7</sup> / <sub>16</sub> " - 24

All parts supplied are S&S Truck Parts Inc./NEWSTAR. Use of other manufacturer's names, part numbers, or trademarks are solely used for informational/identification purposes.

**ROTORS & COMPONENTS**

**COMPLEMENTARY COMPONENTS**

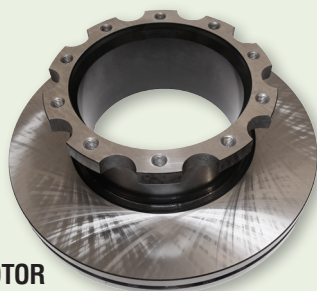

**BRAKE ROTOR**  
S-23223

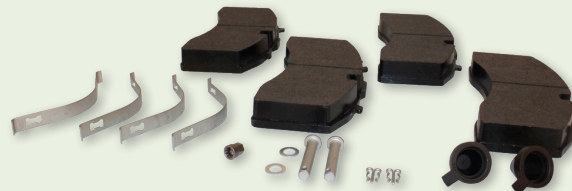

**DISC PAD SET**  
S-21233

NEWSTAR #:	REPLACES #:	DESCRIPTION:	PRODUCT INFORMATION:
<b>S-21233</b>	BX802078 BXK070796	Disc Pad Set	Works w/ 8B6000 & FMSI 8479-D1369 Calipers Includes 4 Pad Assemblies (802078) Includes Dayco Hardware Kit: 7 Springs, 2 Pins, 2 Washers, 2 Split Pins, 1 Hexagonal Adapter & 2 Rubber Caps
<b>S-23223</b>	BX802082	Brake Rotor	Replacement for Bendix Brake Model ADB22X OD: 430.00 mm Height: 150.00 mm Bolt Size: 13.5 mm Bolt Circle: 10 x 250.00 mm

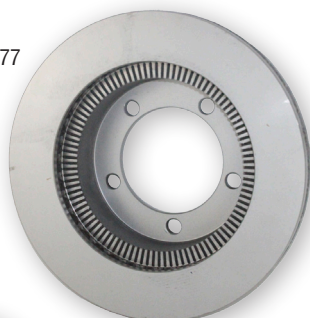

S-11177

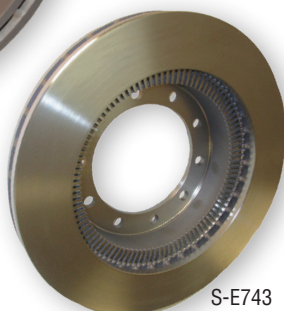
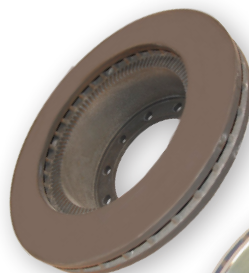

S-13295





S-E743

NEWSTAR #:	REPLACES #:	PRODUCT INFORMATION:
<b>S-11177</b>	3531661C2 2596609C1	4000 & 3000 School Bus Series  OD: 15" Height: 3 1/2" 5 Stud, Dayton Walther Style ABS Exciter Teeth & Rust Inhibitor Coating
<b>S-E743</b>	3531662C1 2596610C1	4000 & 3000 School Bus Series  OD: 15" Height: 3 1/8" 10 Stud, Dayton Walther Style ABS Exciter Teeth & Rust Inhibitor Coating
<b>S-13295</b>	3531663C2 1646750C1 2596611C1	3000 & 4200-4900 Series Medium Duty CE 200, CE 300 & FE 300 School Bus Series  OD: 15" Height: 4 1/2" 10 Stud, Dayton Walther Style ABS Exciter Teeth & Rust Inhibitor Coating

All parts supplied are S&S Truck Parts Inc./NEWSTAR. Use of other manufacturer's names, part numbers, or trademarks are solely used for informational/identification purposes.

## EMERGENCY BRAKE SHOES & COMPONENTS

NEWSTAR #:	REPLACES #:	DESCRIPTION:	PRODUCT INFORMATION:
S-A173	388912C91 A2-3722-G-501	Emergency Brake Shoe	4000 School Bus Series  10" x 3" DCM S Series
S-9985	597577C92	Emergency Brake Shoes	4000 School Bus Series  9" x 3" DCM S Series Set of 2 Shoes





NEWSTAR #:	REPLACES #:	DESCRIPTION:
S-21233	590684C91	Dust Shield



## COMPLEMENTARY COMPONENTS



NEWSTAR #:	REPLACES #:	DESCRIPTION:	PRODUCT INFORMATION:
S-3502	232040R91 A33722E421	Emergency Brake Shoe	4000 Series 4000 School Bus Series  12" x 4" DCM S Series
S-3145	233009R1	Emergency Brake Shoe Springs	4000 Series 4000 School Bus Series  10 Per Package
S-9046	232049R11 A-3736-K-375	Backing Plate	—
S-3886	233010R11 A-3787-N-14	Strut	—
S-C120	388914C1 A-3787-Q-17	Strut	—

All parts supplied are S&S Truck Parts Inc./NEWSTAR. Use of other manufacturer's names, part numbers, or trademarks are solely used for informational/identification purposes.

## 6 HOLE ALUMINUM HUB CAPS

THE FOLLOWING HUB CAPS ARE EQUIPPED WITH:

- Interchange w/ C/R & Stemco
- Include Plug & Gasket
- 5/16" Bolt Size
- 6 Bolt

NEWSTAR #:	REPLACES #:	BOLT CIRCLE (A):	OVERALL HEIGHT (B):	FLANGE I.D. (C):	FLANGE O.D. (D):
<b>S-20000</b>	340-4195 388249C1	6 3/4"	3 11/16"	5 11/16"	7 1/2"
<b>S-B360</b>	343-4009 1657081C91 2033863C9 1695989C91	5 1/2"	2 11/16"	4 3/8"	6 1/4"
<b>S-B358</b>	343-4024	4 1/2"	2 5/8"	3 1/2"	5 1/4"
<b>S-B363</b>	343-4095	5 1/2"	1 13/16"	4 9/16"	6 3/16"
<b>S-B364</b>	343-4249	5 9/16"	1 13/16"	4 7/16"	6 3/16"

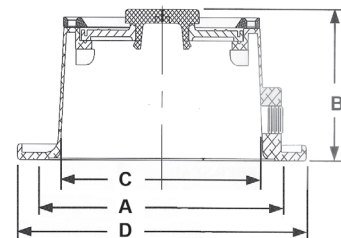

## 5 HOLE ALUMINUM HUB CAPS

THE FOLLOWING HUB CAPS ARE EQUIPPED WITH:

- Interchange w/ C/R & Stemco
- Include Plug & Gasket
- 5/16" Bolt Size
- 5 Bolt

NEWSTAR #:	REPLACES #:	BOLT CIRCLE (A):	OVERALL HEIGHT (B):	FLANGE I.D. (C):	FLANGE O.D. (D):
<b>S-B361</b>	343-4013	5 1/2"	3 11/16"	4 3/8"	6 1/4"

## SPIN OFF HUB CAPS

NEWSTAR #:	REPLACES #:	DESCRIPTION:
<b>S-B359</b>	340-4975	Plastic Fruehauf Spin-Off
<b>S-B362</b>	343-4075	Aluminum Fruehauf Spin-Off



S-B359



S-B362

## ADDITIONAL HUB CAP COMPONENTS

NEWSTAR #:	REPLACES #:	DESCRIPTION:
<b>S-5285</b>	330-3009 388249C	Universal Hub Cap Gasket
<b>S-B365</b>	359-5990	Vent Plug
<b>S-E781</b>	359-5995	Hub Cap Window Kit



S-B365



S-E781

## ADDITIONAL AIR COMPONENTS

NEWSTAR #:	REPLACES #:	DESCRIPTION:	PRODUCT INFORMATION:
<b>S-E858</b>	BX109869 BX298948 BX109871	Wiring Harness	Replacement for Bendix AD-9™, AD-SP™, AD-IP™ & AD-IS™



S-E858



**HOODS**



S-21302

NEWSTAR #:	REPLACES #:	PRODUCT INFORMATION:
<b>S-21302</b>	2010717C1	2500 & 2600 Series (1989-1998) 8200 & 8300 Series (1989-2001) Length: 54"



S-18193

NEWSTAR #:	REPLACES #:	PRODUCT INFORMATION:
<b>S-18193</b>	2023778C1	3800, 4600, 4700 & 4900 Series (1989-2002) Length: 44 1/2"



S-18192

NEWSTAR #:	REPLACES #:	PRODUCT INFORMATION:
<b>S-18192</b>	3521968C91	9200 Series (1997-1999) Length: 59 1/2" Flat Windshield



S-18194

NEWSTAR #:	REPLACES #:	PRODUCT INFORMATION:
<b>S-18194</b>	3521969C91	9400 Series (1997-1999) Length: 65" Flat Windshield

All parts supplied are S&S Truck Parts Inc./NEWSTAR. Use of other manufacturer's names, part numbers, or trademarks are solely used for informational/identification purposes.

## HOODS

NEWSTAR #:	REPLACES #:	PRODUCT INFORMATION:
S-18197	3537837C	7300-7500 Series Length: 40"



NEWSTAR #:	REPLACES #:	PRODUCT INFORMATION:
S-18196	3551824C	9200I Series (1999-2009) Length: 54" Curved Windshield



NEWSTAR #:	REPLACES #:	PRODUCT INFORMATION:
S-18195	3551825C	9400I Series (1999-2009) Length: 60" Curved Windshield

## HOOD COMPONENTS

### COMPLEMENTARY COMPONENTS

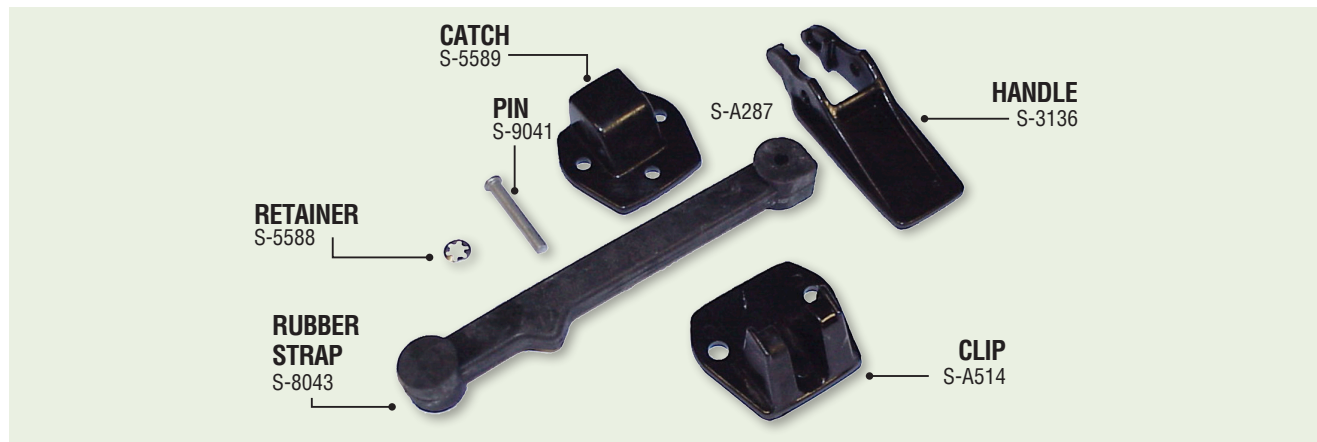

NEWSTAR #:	REPLACES #:	DESCRIPTION:	PRODUCT INFORMATION:
S-A287	1699929C91 500269ASSY	Hood Hold Down Kit	4700, 4900, 7100, 8100-8300 & S Series Medium Duty
<b>CONSISTS OF:</b>			
S-5589	500271C1	Catch	—
S-3136	500269C1	Handle	—
S-A514	500274C1	Clip	—
S-8043	499523C1	Rubber Strap	—
S-5588	500270C1	Retainer	—
S-9041	500273C1	Pin	—

**AVAILABLE AS A KIT OR SEPERATELY**

All parts supplied are S&S Truck Parts Inc./NEWSTAR. Use of other manufacturer's names, part numbers, or trademarks are solely used for informational/identification purposes.

## HOOD COMPONENTS

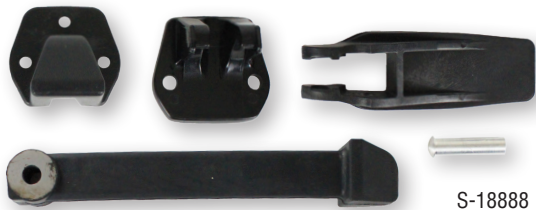

NEWSTAR #:	REPLACES #:	DESCRIPTION:	PRODUCT INFORMATION:
<b>S-18888</b>	1699930C92	Hood Hold Down Kit	9000 Series

S-18888



S-21821

S-11605

NEWSTAR #:	REPLACES #:	DESCRIPTION:	PRODUCT INFORMATION:
<b>S-21821</b>	3544924C1	Hood Latch	4100-4400 Series Medium Duty
<b>S-11605</b>	3558776C1	Hood Latch	4700, 4900, 7100 & 8100-8300 Series



S-20631

NEWSTAR #:	REPLACES #:	DESCRIPTION:	PRODUCT INFORMATION:
<b>S-20631</b>	3551734C2	Hood Safety Cable	3200, 3300, FBC, BE & CE200-300 School Bus Series 

## COMPLEMENTARY COMPONENTS



**HOOD BUMPER**  
S-4921



**HOOD GUIDE**  
S-2983

NEWSTAR #:	REPLACES #:	DESCRIPTION:	PRODUCT INFORMATION:
<b>S-2983</b>	472697C1	Hood Guide	4000 & S Series
<b>S-4921</b>	472698C1	Hood Bumper	

## HOOD COMPONENTS

NEWSTAR #:	REPLACES #:	DESCRIPTION:	PRODUCT INFORMATION:
<b>S-3061</b>	491668C92	Hood Catch Kit	4000, 8000, 9370 & 9670 Series 3000 & 3800 School Bus Series (May 1997 & Up)
<b>RETAINER S-21189 (777937C1) AVAILABLE SEPERATELY</b>			

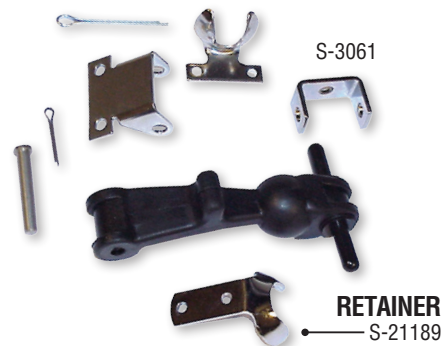

NEWSTAR #:	REPLACES #:	DESCRIPTION:	PRODUCT INFORMATION:
<b>S-21313</b>	598574C	Hood Spring	2500, 2600, 9100, 9200 & 9400 Series
<b>S-21242</b>	1675762C2	Hood Spring	2500 Series Medium Duty (January 1998 & Up) 3000 & 3800 School Bus Series (June 1997 & Up) 4700-4900 Series Medium Duty (June 1997 & Up)
<b>S-21122</b>	3588532C2	Hood Spring	9000 Series



## GRILLES

NEWSTAR #:	REPLACES #:	PRODUCT INFORMATION:
<b>S-18203</b>	3566927C91	9100, 9100I, 9200, 9200I, 9400 & 9400I Series (1997 & Up) Width: 41 3/4" Height: 23 3/4" Chrome Finish

### MATING COMPONENTS



**GRILLE BEZEL (S-23056)**  
Replaces:  
3501482C1



NEWSTAR #:	REPLACES #:	PRODUCT INFORMATION:
<b>S-18662</b>	3551015C99	4200, 4300 & 4400 Series Dimensions: 57" x 25" Plastic Chrome



## GRILLE BEZELS

NEWSTAR #:	REPLACES #:	PRODUCT INFORMATION:
<b>S-23056</b>	3501482C1	9200 & 9400 Premium Conventionals 5500I, 5600I & 5900I Conventionals Polished Aluminum



All parts supplied are S&S Truck Parts Inc./NEWSTAR. Use of other manufacturer's names, part numbers, or trademarks are solely used for informational/identification purposes.



**BUMPERS**



NEWSTAR #:	REPLACES #:	PRODUCT INFORMATION:
<b>S-23258</b>	3610930C	4200-4300 & 8600 Series (2004 & Up) 1 Piece Large Tow Hooks Painted Silver Finish
<b>S-23002</b>	3610935C	4200-4300 & 8600 Series 1 Piece Large Tow Hooks Chrome Finish
<b>S-23843</b>	3610939C	4200-4300 & 8600 Series 1 Piece Large Tow Hooks Black Finish



NEWSTAR #:	REPLACES #:	PRODUCT INFORMATION:
<b>S-22358</b>	AM0420SSC	9100, 9200 & 9400 Series Chrome Finish, Stainless Steel Clad Aluminum 11 Gauge
<b>S-18988</b>	3502239C2	9100, 9200 & 9400 Series Chrome Over Steel 11 Gauge



NEWSTAR #:	REPLACES #:	PRODUCT INFORMATION:
<b>S-23235</b>	AM0421SSC	Prostar Linehaul Conventionals Chrome Finish, Stainless Steel Clad Aluminum 11 Gauge Includes Mounting Brackets & Fillers

All parts supplied are S&S Truck Parts Inc./NEWSTAR. Use of other manufacturer's names, part numbers, or trademarks are solely used for informational/identification purposes.

## BUMPER COMPONENTS

NEWSTAR #:	REPLACES #:	DESCRIPTION #:	PRODUCT INFORMATION:
S-22214	3720617C3	Bumper End, LH	Prostar Linehaul Conventionals
S-22213	3720618C3	Bumper End, RH	



## FENDER EXTENSIONS

NEWSTAR #:	REPLACES #:	DESCRIPTION:	PRODUCT INFORMATION:
S-18449	1657747C1	Fender Extension, LH	3800, 4700 & 4900 Series
S-18448	1657748C1	Fender Extension, RH	



NEWSTAR #:	REPLACES #:	DESCRIPTION:	PRODUCT INFORMATION:
S-18201	3518981C5	Fender Extension, RH	9100, 9100I, 9200, 9200I, 9400 & 9400I Series
S-18202	3518982C5	Fender Extension, LH	



NEWSTAR #:	REPLACES #:	DESCRIPTION:	PRODUCT INFORMATION:
S-18199	3566716C2	Fender Extension, LH	4300, 4400 & 8500 Series
S-18200	3566717C2	Fender Extension, RH	

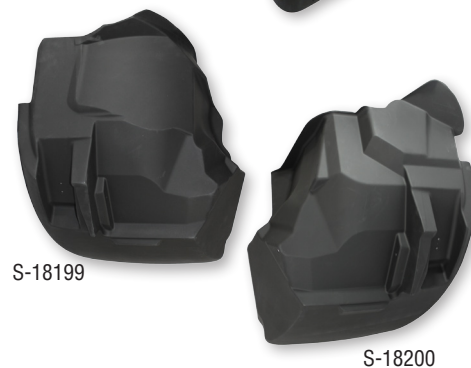

## HOOD EXTENSIONS

NEWSTAR #:	REPLACES #:	DESCRIPTION:	PRODUCT INFORMATION:
S-22310	3805331C99	Hood Extension, LH	Prostar Linehaul Conventionals
S-22309	3805332C99	Hood Extension, RH	



All parts supplied are S&S Truck Parts Inc./NEWSTAR. Use of other manufacturer's names, part numbers, or trademarks are solely used for informational/identification purposes.

LAMPS

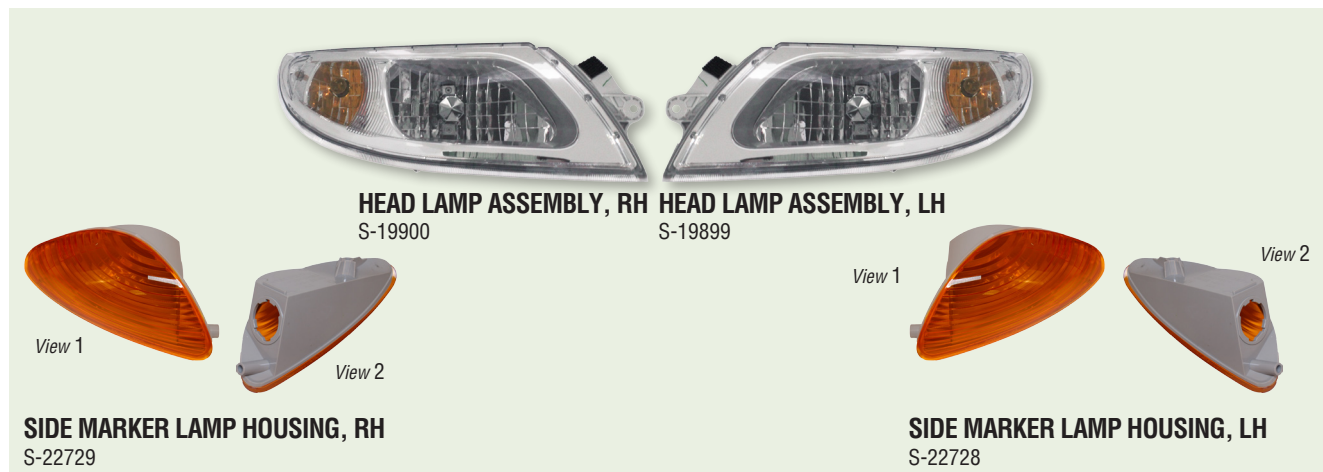

COMPLEMENTARY COMPONENTS



NEWSTAR #:	REPLACES #:	DESCRIPTION:	PRODUCT INFORMATION:
S-22728	3561965C1	Side Marker Lamp Housing, LH	4100-4400 & CE200/300 School Bus Series 
S-22729	3561966C1	Side Marker Lamp Housing, LH	
S-19899	3574387C94 4020383C91	Head Lamp Assembly, LH	
S-19900	3574388C94 4020384C91	Head Lamp Assembly, RH	

COMPLEMENTARY COMPONENTS



NEWSTAR #:	REPLACES #:	DESCRIPTION:	PRODUCT INFORMATION:
S-A644	1686721C91	Head Lamp	3800, 4700, 4800, 8100 & 8200 Models (1995-2004)
S-19975	1661763C1	Bezel, LH	3000 Series School Bus (1997 & Before) 
S-19976	1661764C1	Bezel, RH	3800 School Bus Models (May 1997 & Up) 



NEWSTAR #:	REPLACES #:	DESCRIPTION:	PRODUCT INFORMATION:
S-21414	2505366C91	Turn Signal Lamp, LH	9000-9200, 9400 & 9900
S-21415	2505369C91	Turn Signal Lamp, RH	Series Premium Conventionals

All parts supplied are S&S Truck Parts Inc./NEWSTAR. Use of other manufacturer's names, part numbers, or trademarks are solely used for informational/identification purposes.

## LAMPS

NEWSTAR #:	REPLACES #:	DESCRIPTION:	PRODUCT INFORMATION:
S-22794	3596015C95	Head Lamp Assembly, LH	Prostar Linehaul Conventionals
S-22795	3596016C95	Head Lamp Assembly, RH	



S-22794



S-22795

## LAMP BEZELS

### COMPLEMENTARY COMPONENTS



**CHROME BEZEL, RH**  
S-21413



**CHROME BEZEL, LH**  
S-21412



**COMPLETE ASSEMBLY, RH**  
S-21411



**COMPLETE ASSEMBLY, LH**  
S-21408

NEWSTAR #:	REPLACES #:	DESCRIPTION:	PRODUCT INFORMATION:
S-21408	3502928C91	Complete Assembly, LH	9000-9200, 9400 & 9900 Series Premium Conventionals
S-21411	3502929C91	Complete Assembly, RH	
S-21412	2505370C1	Chrome Bezel, LH	
S-21413	2505371C1	Chrome Bezel, RH	

## DOOR COMPONENTS

NEWSTAR #:	REPLACES #:	DESCRIPTION:	PRODUCT INFORMATION:
S-13951	477257C94	Door Latch, LH	1000 & 4000 Series
S-13952	477258C94	Door Latch, RH	



S-13951

NEWSTAR #:	REPLACES #:	DESCRIPTION:	PRODUCT INFORMATION:
S-7630	498003C2	Door Latch, LH	9370 & 9670 Series (June 1989 & Before)
S-7631	498004C2	Door Latch, RH	



S-7630

All parts supplied are S&S Truck Parts Inc./NEWSTAR. Use of other manufacturer's names, part numbers, or trademarks are solely used for informational/identification purposes.



## DOOR COMPONENTS



S-17329

NEWSTAR #:	REPLACES #:	DESCRIPTION:	PRODUCT INFORMATION:
<b>S-17329</b>	1677433C2	Door Latch, LH	9670 Series (August 1989 & Up)
<b>S-17330</b>	1677434C2	Door Latch, RH	



S-21953

NEWSTAR #:	REPLACES #:	DESCRIPTION:	PRODUCT INFORMATION:
<b>S-21953</b>	3549259C2	Door Hinge	4200-4400 Series Lonestar & Prostar Linehaul Conventionals

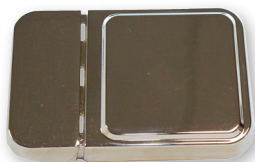

S-E627

NEWSTAR #:	REPLACES #:	DESCRIPTION:	PRODUCT INFORMATION:
<b>S-E627</b>	3550931C91 3550925C	Door Handle	4700, 4900, 7100, 8100, 8200 & 8300 Series



S-18290

NEWSTAR #:	REPLACES #:	DESCRIPTION:	PRODUCT INFORMATION:
<b>S-17330</b>	1677434C2	Door Lock, LH	9670 Series (August 1989 & Up)
<b>S-18290</b>	1677435C2	Door Lock, RH	

## WINDOW COMPONENTS



S-9409



S-9410

NEWSTAR #:	REPLACES #:	DESCRIPTION:	PRODUCT INFORMATION:
<b>S-9409</b>	1686704C91	Window Regulator, LH	S-Series & 4000 Series Chassis (1991 & Up)
<b>S-9410</b>	1686705C91	Window Regulator, RH	

All parts supplied are S&S Truck Parts Inc./NEWSTAR. Use of other manufacturer's names, part numbers, or trademarks are solely used for informational/identification purposes.

## WINDOW COMPONENTS

NEWSTAR #:	REPLACES #:	DESCRIPTION:	PRODUCT INFORMATION:
<b>S-8530</b>	1649776C1	Window Handle	9670, 9370, Paystar, Transtar, COF5870 & S Series Dark Finish
<b>S-3200</b>	475196C1	Window Handle	9670, 9370, Paystar, Transtar, COF5870 & S Series Chrome Finish



NEWSTAR #:	REPLACES #:	DESCRIPTION:	PRODUCT INFORMATION:
<b>S-22411</b>	2504705C1	Nozzle Kit	4100-4400 Series BE200, CE200 & 300 School Bus Series 



NEWSTAR #:	REPLACES #:	DESCRIPTION:	PRODUCT INFORMATION:
<b>S-14004</b>	1696499C	Washer Fluid Nozzle Assembly	5000, 5000I, 5600, 5900, 9100, 9200, 9400, 9900 & 5800 Series 3000 School Bus Series (May 1997 & Before)  4000 Series Medium Duty (May 1997 & Before) 9000 Series Premium Conventionals

### MATING COMPONENTS



NEWSTAR #:	REPLACES #:	DESCRIPTION:	PRODUCT INFORMATION:
<b>S-21761</b>	446883001	Washer Pump	000FE, RE, BE200, CE200, 300, FE300, RE300 School Bus Series  5500I, 5600I & 5900I Series Severe Service Conventionals 9200, 9400 & 9900 Premium Conventionals



NEWSTAR #:	REPLACES #:	DESCRIPTION:	PRODUCT INFORMATION:
<b>S-21201</b>	3527221C1	Wiper Arm, LH	5000, 5000I, 5600I & 5900I Series Severe Duty 9100, 9200, 9400 & 9900 Premium Conventionals 9800 Series Premium Cabovers



All parts supplied are S&S Truck Parts Inc./NEWSTAR. Use of other manufacturer's names, part numbers, or trademarks are solely used for informational/identification purposes.

**MIRRORS**

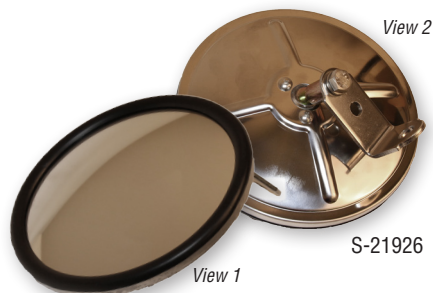

NEWSTAR #	DESCRIPTION:	PRODUCT INFORMATION:
S-21926	5" Convex Mirror	Center Mount "L" Bracket Included for Easy Replacement Stainless Steel Finish



NEWSTAR #	DESCRIPTION:	PRODUCT INFORMATION:
S-21927	6" Convex Mirror	Center Mount "L" Bracket Included for Easy Replacement Stainless Steel Finish



NEWSTAR #	DESCRIPTION:	PRODUCT INFORMATION:
S-21928	8.5" Convex Mirror	Center Mount "L" Bracket Included for Easy Replacement Stainless Steel Finish



NEWSTAR #	DESCRIPTION:	PRODUCT INFORMATION:
S-21929	8.5" Convex Mirror	"L" Bracket Included for Easy Replacement Stainless Steel Finish



NEWSTAR #	DESCRIPTION:	PRODUCT INFORMATION:
S-21930	8.5" Convex Mirror	Bubble Center Includes Mounting Stud & Bolt Stainless Steel Finish

All parts supplied are S&S Truck Parts Inc./NEWSTAR. Use of other manufacturer's names, part numbers, or trademarks are solely used for informational/identification purposes.

**MIRRORS**

NEWSTAR #	DESCRIPTION:	PRODUCT INFORMATION:
S-21931	7" X 16" West Coast Mirror, LH/RH	Commonly Used on Western Star, Peterbilt & Kenworth Models OEM Style-Flat Back Heated Polished Stainless Steel Finish

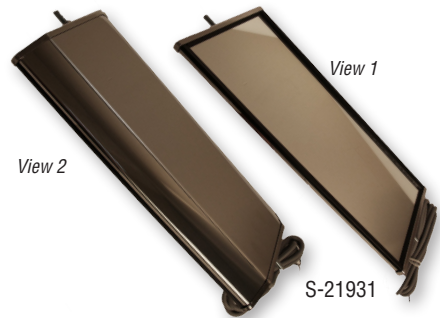

NEWSTAR #	DESCRIPTION:	PRODUCT INFORMATION:
S-21932	7" X 16" West Coast Mirror, LH/RH	Commonly Used on Western Star, Peterbilt & Kenworth Models Includes Amber Lens MarkerLAMP Includes Hardware OEM Style-Flat Back Heated Polished Stainless Steel Finish



NEWSTAR #	DESCRIPTION:	PRODUCT INFORMATION:
S-21935	7" X 16" West Coast Mirror, LH/RH	Commonly Used on GM, Ford, Sterling, Mack & International Models Pyramid/Peak Back/ V-Back Style Includes Hardware Stainless Steel Finish



NEWSTAR #	DESCRIPTION:	PRODUCT INFORMATION:
S-21936	7" X 16" West Coast Mirror, LH/RH	Commonly Used on Western Star, Peterbilt & Kenworth Models OEM Style-Flat Back Includes Hardware Stainless Steel Finish



NEWSTAR #	DESCRIPTION:	PRODUCT INFORMATION:
S-21937	7" X 16" West Coast Mirror, LH/RH	Commonly Used on GM, Ford, Sterling, Mack & International Models Includes Convex Spot Mirror Includes Amber Lens MarkerLAMP Includes Hardware Heated Stainless Steel Finish

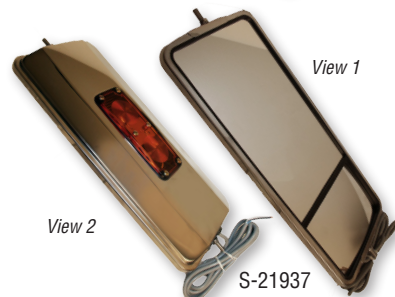

All parts supplied are S&S Truck Parts Inc./NEWSTAR. Use of other manufacturer's names, part numbers, or trademarks are solely used for informational/identification purposes.



## MIRRORS

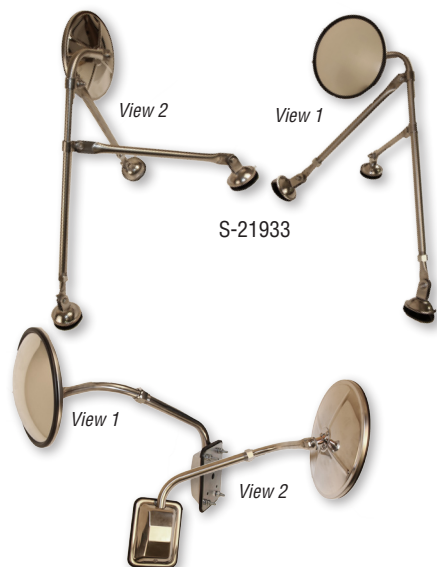

NEWSTAR #:	DESCRIPTION:	PRODUCT INFORMATION:
<b>S-21933</b>	Fender Tripod, LH/RH	Adjustable 21" - 32.75" Tripod w/ 8 1/2" Convex Mirror Adjustable Safety Mirror & Bracket Stainless Steel Finish

NEWSTAR #:	DESCRIPTION:	PRODUCT INFORMATION:
<b>S-21934</b>	Pod Mount Mirror, LH/RH	Includes Backing Plate, Gasket & Mounting Hardware Includes Single Arm & 8 1/2" Convex Mirror Stainless Steel Finish

## FUEL CAPS



NEWSTAR #:	REPLACES #:	PRODUCT INFORMATION:
<b>S-17331</b>	508010C91	4000 Series Non-Locking Aluminum Nominal Size: 3" Threaded Neck: 4"
<b>S-A968</b>	576746C91	Non-Locking Aluminum Vented # of Threads: 11.5 Threaded Neck: 2"
<b>S-17348</b>	2040848C91	Non-Locking Aluminum Spring Loaded Vented # of Threads: 8 Threaded Neck: 3"

## HANGERS & COMPONENTS

NEWSTAR #:	REPLACES #:	DESCRIPTION:	PRODUCT INFORMATION:
S-22277	647-SL	2 1/2" Angled	Includes 2 Hangers Spring Loaded Chrome Finish
S-22278	647S-SL	2 1/2" Angled	Includes 2 Hangers Spring Loaded Stainless Finish

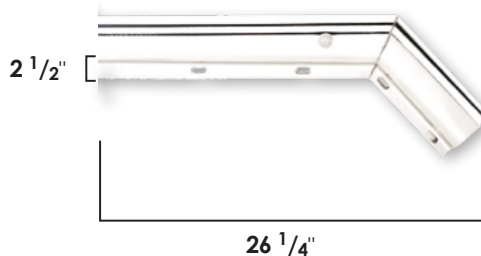

NEWSTAR #:	REPLACES #:	DESCRIPTION:	PRODUCT INFORMATION:
S-22280	648-SL	1 1/8" Angled	Includes 2 Hangers Chrome Finish
S-22281	648S-SL	1 1/8" Angled	Includes 2 Hangers Stainless Finish
S-22279	648B-SL	1 1/8" Angled	Includes 2 Hangers Black Finish

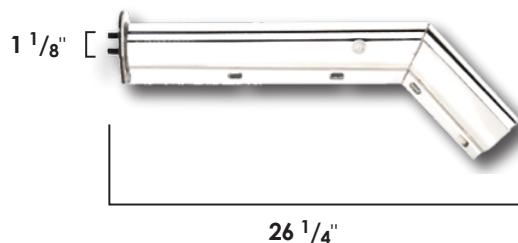

NEWSTAR #:	REPLACES #:	DESCRIPTION:	PRODUCT INFORMATION:
S-22282	646-SL	2 1/2" Straight	Includes 2 Hangers Spring Loaded Chrome Finish
S-22283	646S-SL	2 1/2" Straight	Includes 2 Hangers Spring Loaded Stainless Finish
S-22284	646B-SL	2 1/2" Straight	Includes 2 Hangers Spring Loaded Black Finish

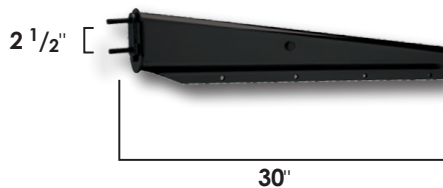

NEWSTAR #:	REPLACES #:	DESCRIPTION:	PRODUCT INFORMATION:
S-22675	649-SL	1 1/8" Straight	Includes 2 Hangers Chrome Finish
S-22676	649S-SL	1 1/8" Straight	Includes 2 Hangers Stainless Finish
S-22674	649B-SL	1 1/8" Straight	Includes 2 Hangers Black Finish

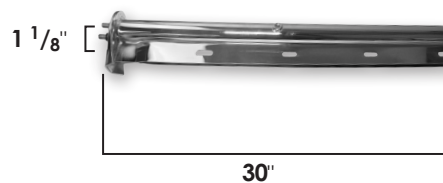

NEWSTAR #:	REPLACES #:	DESCRIPTION:
S-22276	640	Anti-Sail Hold Down



All parts supplied are S&S Truck Parts Inc./NEWSTAR. Use of other manufacturer's names, part numbers, or trademarks are solely used for informational/identification purposes.

## HUB COVERS

NEWSTAR #:	REPLACES #:	DESCRIPTION:	PRODUCT INFORMATION:
S-22677	ACX40200	Hub Cover Set	Chrome Finish
S-23593	MW971	Hub Cover Set Front	Chrome Finish



S-22677

NEWSTAR #:	REPLACES #:	DESCRIPTION:	PRODUCT INFORMATION:
S-22678	MW1273BK	Wheel Hub Cover	5 Notch Chrome Over Steel
S-22679	MW1285BK	Wheel Hub Cover	5 Notch Stainless Steel Finish



View 1

View 2

S-22679

## QUARTER FENDERS

NEWSTAR #:	REPLACES #:	DESCRIPTION:	PRODUCT INFORMATION:
S-22285	742-S	24" Quarter Fender Set	Includes Mounting Pins & Bolts Stainless Steel Includes Left & Right Fenders

### MATING COMPONENTS

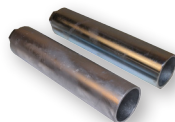

**POST KIT**  
(S-23091)  
Single Bolt, 2 Posts,  
Includes Washers & Bolts

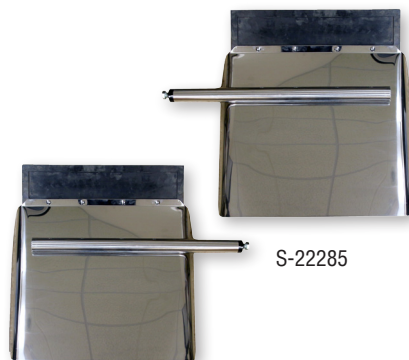

S-22285

NEWSTAR #:	REPLACES #:	DESCRIPTION:	PRODUCT INFORMATION:
S-22382	FLT1900KIT	24" Quarter Fender Set	Includes Clamp High Impact Plastic Includes Left & Right Fenders

### MATING COMPONENTS

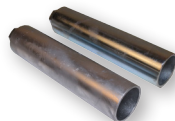

**POST KIT**  
(S-23091)  
Single Bolt, 2 Posts,  
Includes Washers & Bolts



S-22382

**HORNS**

**COMPLEMENTARY COMPONENTS**



**HORN, HIGH**  
S-4730



**HORN, LOW**  
S-4731

NEWSTAR #:	REPLACES #:	DESCRIPTION:	PRODUCT INFORMATION:
S-4730	411948C91 165519R91	Horn, High	S Series Medium & Heavy Duty 4000, 8000, 9370 & 9670 Series
S-2634	411949C91 166166R91	Horn, Low	

**COMPLEMENTARY COMPONENTS**



**HORN, LOW**  
S-17570



**HORN, HIGH**  
S-17571

NEWSTAR #:	REPLACES #:	DESCRIPTION:	PRODUCT INFORMATION:
S-17570	3523179C91 3903524C91	Horn, Low	S Series Medium & Heavy Duty 4000 & 8000 Series 9370 & 9670 Models
S-17571	3523180C91	Horn, High	

All parts supplied are S&S Truck Parts Inc./NEWSTAR. Use of other manufacturer's names, part numbers, or trademarks are solely used for informational/identification purposes.



**ADDITIONAL CAB & BODY COMPONENTS**

NEWSTAR #:	REPLACES:	DESCRIPTION:	PRODUCT INFORMATION:
S-22286	1301	Air Cleaner Complete Kit	15" Vortex Style 7" Outlet 304 Stainless Steel Finish Includes Housing, 2 Mounting Straps & Mounting Plate Held Together w/ Long Bolt through Middle of Housing



NEWSTAR #:	REPLACES #:	DESCRIPTION:
S-7691	1669309C2	Key Blank



NEWSTAR #:	REPLACES #:	DESCRIPTION:	PRODUCT INFORMATION:
S-3204	286655C4	Shift Boot	4000 & S Series Medium Duty



NEWSTAR #:	REPLACES #:	DESCRIPTION:
S-15593	2032580C91	Luggage Box Cable



NEWSTAR #:	REPLACES #:	DESCRIPTION:
S-C459	682506R91	Air Horn Valve



NEWSTAR #:	REPLACES #:	DESCRIPTION:
S-5116	244283R1	Chrome Dual Air Horn



All parts supplied are S&S Truck Parts Inc./NEWSTAR. Use of other manufacturer's names, part numbers, or trademarks are solely used for informational/identification purposes.

## WARNING TRIANGLE REFLECTOR KIT

### COMPONENTS & FEATURES:

- 3 Collapsible Reflective Triangles In Compact, 1 Piece Storage Box
- Rotate 1/4 Turn & Still Stay Upright In Heavy Traffic Or Bad Weather
- Weighted Bases
- No Tools Required For Setup
- Meets DOT, NHTSA & FMVSS 125 Requirements

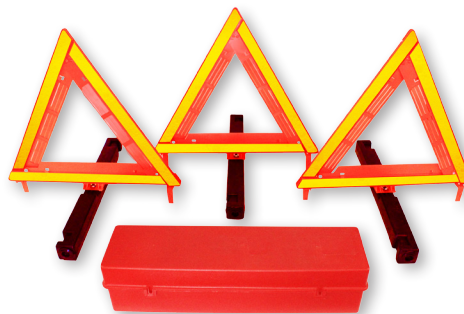

NEWSTAR #:	PRODUCT INFORMATION:
S-18223	M Series Dimensions: 17" x 17" 3 Per Box Weight: 2lbs 15oz Each

All parts supplied are S&S Truck Parts Inc./NEWSTAR. Use of other manufacturer's names, part numbers, or trademarks are solely used for informational/identification purposes.

**U-JOINTS**



NEWSTAR #:	REPLACES #:	REPLACEMENT FOR DANA® #	SERIES:
S-9671	208959R91	5-103X	1000
S-7021	ZKC115 108991R92 1662198C91	5-115X	1500
S-9684	—	5-1204X	55
S-1802	ZKC1206I ZAD286600 219193R91	5-1206X	55
S-7022	ZKC124 974180R93	5-124X	1800
S-B821	—	5-1300X	5160
S-9846	—	5-1306X	7260
S-A163	—	5-1309X	7290
S-7023	—	5-134X	1310-1330
S-B118	—	5-137X	—
S-2171	ZKC153Q 645573R91 121406R92	5-153X 5-121X	1260-1270 & 1310
S-7024	ZKC155Q 213882C91 213882R91	5-155X	1550
S-2860	ZKC160Q 127574R91	5-160X	1410
S-7025	ZKC165 751762C91	5-165X	1650
S-7026	ZKC170 252577C91 447797C91	5-170X	1000
S-7027	ZKC178Q 127573R91	5-178X	1350
S-7029	ZKC188 913774R91	5-188X	1480
S-9683	—	5-213X	1330
S-7030	—	5-260X	1310 WJ
S-7434	ZKC279Q ZAD-11516 121684R92 1676278C91	5-279X	1610
S-7435	ZKC280Q ZAD-11577 121762R92	5-280X®	1710
S-2627	ZKC281 422910C91	5-281X	1810
S-7658	ZKC297 459395C91	5-297X	1310 HDWJ
S-13953	—	5-308X	1880
S-9347	—	5-3147X	3RL
S-6101	—	5-324X	1810 Mack
S-7889	—	5-326X	1880-9C Mack

SPL\_\_X® is a trademark of Dana Corp

All parts supplied are S&S Truck Parts Inc./NEWSTAR. Use of other manufacturer's names, part numbers, or trademarks are solely used for informational/identification purposes.

## U-JOINTS

NEWSTAR #:	REPLACES #:	REPLACEMENT FOR DANA® #	SERIES:
S-C587	—	5-332X	1480WJ
S-9845	—	5-353X	1260 & 1310-7260
S-6110	—	5-4002X	4CL
S-6099	ZKC407Q 578379C91	5-407X	1760
S-11832	—	5-4140X	4CBL
S-7798	1650879C91 1696914C91	5-438X	1610 1/2 Round
S-7031	1658881C91 1696917C91	5-469X	1760 1/2 Round
S-13841	—	5-5031X	5CBL
S-7032	165888291 1696916C91	5-510X	1810 1/2 Round
S-7033	1658880C91 1696915C91	5-515X	1710 1/2 Round
S-6113	—	5-5177X	5CSRL
S-6921	—	5-5800XX	58WB
S-6919	—	5-5801X	58WB
S-6920	—	5-5802X	58WB
S-6125	ZKC6100 65351R93	5-6000X	6CL
S-6109	—	5-6102X	6CBL
S-6107	—	5-6106X	6BL
S-C472	ZKC5674	5-674X	1610 1/2 Round
S-C473	ZKC675	5-675X	1710 1/2 Round
S-C474	ZKC5676	5-676X	1810 1/2 Round
S-C475	ZKC677 2502647C91	5-677X	1760 1/2 Round
S-1720	ZKC7000 136512HB	5-7000X	7LN
S-6118	—	5-7105X	7LN
S-6116	ZKC7202 140604R92	5-7202X	7CBL
S-13211	ZKC785	5-785X	1310
S-6126	—	5-8105X	8BL
S-6123	ZKC8200 69557R93	5-8200X	8LN
S-6124	—	5-8202X	8CBL
S-6117	—	5-9001X	9C
S-11158	—	5-9017X	9C
S-6918	ZKC92 150635R92	5-92X	L6N
S-C186	—	—	850N

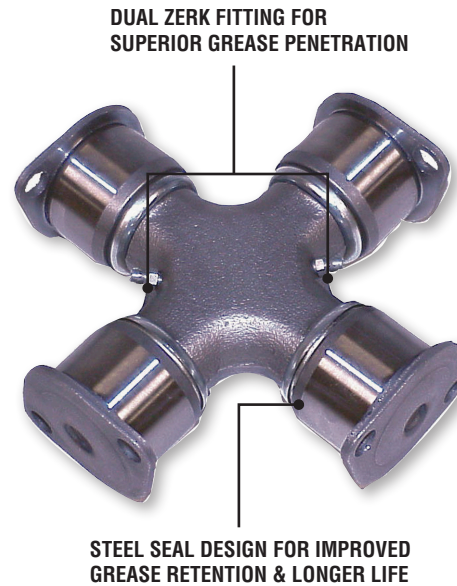

- 1 Year Unlimited Mile Warranty
- ISO9000 Certified

All parts supplied are S&S Truck Parts Inc./NEWSTAR. Use of other manufacturer's names, part numbers, or trademarks are solely used for informational/identification purposes.



## U-JOINTS



NEWSTAR #:	REPLACES #:	REPLACEMENT FOR DANA® #	SERIES:
<b>S-B117</b>	—	S-55-55-2	55
<b>S-E129</b>	—	SPL90X®	SPL®
<b>S-14117</b>	2506391C91 1681117C91	SPL100-1X®	SPL®
<b>S-E358</b>	2500678C91	SPL170X®	SPL®
<b>S-E359</b>	2500680C91	SPL250X®	SPL®

## STRAP KITS



NEWSTAR #:	REPLACES #:	REPLACEMENT FOR DANA #:	PRODUCT INFORMATION:
<b>S-D689</b>	—	2-8-59	1710, 1760, & 1810 Series
<b>S-B608</b>	1662835C91	2-70-18X	1310 & 1330 Series
<b>S-B609</b>	1662836C91	2-70-28X	1310 & 1330 Series
<b>S-B612</b>	1662883C91	3-70-28X	1350 & 1410 Series
<b>S-B613</b>	1658833C91	3-70-38X	1480 & 1550 Series
<b>S-A955</b>	1658834C91	5-70-28X	1610 Series
<b>S-A293</b>	1658835C91	6.5-70-18X	1710, 1760 & 1810 Series
<b>S-D756</b>	1658128C91 1685128C91	90-70-28X	SPL90X® Series
<b>S-D757</b>	2500674C91	170-70-28X	SPL170X® Series
<b>S-D758</b>	2500675C91	250-70-28X	SPL250X® Series
<b>S-E715</b>	2507286C91	212214X	1710 Series

## U-BOLT KITS



NEWSTAR #:	REPLACES #:	REPLACEMENT FOR DANA #:	PRODUCT INFORMATION:
<b>S-15366</b>	—	2-94-58X	1330F
<b>S-B614</b>	1662181C91	3-94-18X	1350 & 1410
<b>S-B615</b>	1662182C91	3-94-28X	1480 & 1550

SPL\_\_X® is a trademark of Dana Corp

All parts supplied are S&S Truck Parts Inc./NEWSTAR. Use of other manufacturer's names, part numbers, or trademarks are solely used for informational/identification purposes.

## CENTER BEARINGS

NEWSTAR #:	REPLACES #:	REPLACEMENT FOR DANA #:	PRODUCT INFORMATION:
<b>S-7935</b>	1662709C91 283067C93	210084-2X	1550, 1610 & 1650 Series
<b>S-7934</b>	1662710C91 1676270C91 386418C91	210088-1X	1280 & 1310 Series
<b>S-1980</b>	ZKC2101211X 1662711C91 1676271C91 283069C93 291870C91 2591050C91 2593349C1	210121-1X	1710 Series
<b>S-D458</b>	1662712C91	210130-1X	1550 & 1610 Series
<b>S-D460</b>	1662713C91	210140-1X	1350, 1410 & 1480 Series
<b>S-C448</b>	466505C91	210207-1X	1550, 1610 & 1650 Series
<b>S-D459</b>	1662722C91	210367-1X	1280, 1310, 1330, 1350 & 1410 Series
<b>S-7020</b>	ZKC2103911X 1676273C91 315442C91 484002C91 ZMB2103911X 2591051C91	210391-1X	1310, 1410 & 1480 Series
<b>S-E319</b>	ZKC2104331X	210433-1X	1410 & 1480 Series
<b>S-7926</b>	ZKC2106611X 1662725C91 1676305C91 283071C93	210661-1X	1760 & 1810 Series
<b>S-B240</b>	ZKC408661X ZKC2108661X	210866-1X	1310-1550 Series
<b>S-B333</b>	1669550C91 2591053C91	210875-1X	1760 & 1810 Series
<b>S-18847</b>	2591048C91	CB210661-1XSA	1760 & 1810 Series Self Aligning Includes 2 Slings (DEFR55-1)



S-18847

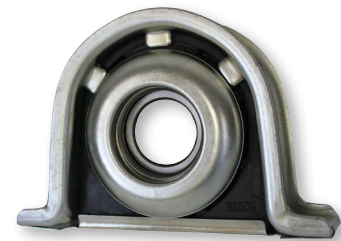

S-7935



S-D458

## HINGED CLUTCH BRAKES



S-15475

NEWSTAR #:	REPLACES #:	DESCRIPTION :	DIMENSION "A" :
S-15475	1677144C1	2" (3/8" Thick)	2 1/2" - 2 37/64"
S-16422	—	2" (29/64" Thick)	2 37/64" - 2 21/32"
S-16423	—	2" (1/2" Thick)	2 21/32" - 2 23/32"
S-16424	—	2" (35/64" Thick)	2 23/32" - 2 49/64"
S-16425	—	1 3/4" (3/8" Thick)	2 1/2" - 2 37/64"

## TORQUE LIMITING CLUTCH BRAKES

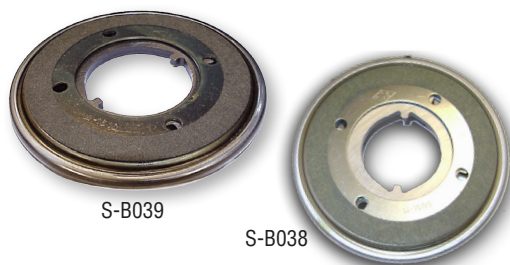

S-B039

S-B038

NEWSTAR #:	REPLACES #:	DESCRIPTION :	DIMENSION "A" :
S-B038	69883R1	1-3-4" (3/8" Thick)	2 1/2" - 2 37/64"
S-17669	—	1-3-4" (1/2" Thick)	2 37/64" - 2 23/32"
S-B039	797700C1	2" (3/8" Thick)	2 1/2" - 2 37/64"
S-17670	—	2" (29/64" Thick)	2 37/64" - 2 21/32"
S-17671	—	2" (1/2" Thick)	2 21/32" - 2 37/64"

## CLUTCH BRAKE SHIMS



S-17672

NEWSTAR #	DESCRIPTION:	DIMENSION "A":
S-17672	2" (1/8" Thick)	2 37/64" - 2 21/32"
S-17673	2" (3/16" Thick)	2 21/32" - 2 37/64"

## CLUTCH RELEASE FORKS





S-19996



S-7440

NEWSTAR #:	REPLACES #:	PRODUCT INFORMATION:
S-7440	697924R6 NSDS105C137	Dana 13, 14 & 15 1/2" Clutches DT466, T444E & VT375 Engine Models
S-19996	300781C1	4000 & 7000 Series 3400, 3600, 3700, 3900 School Bus Series (May 1997 & Before)  DT466, T444E & 7.3 Engine Models Works w/ 14" & 15 1/2" 2 Plate Clutch

## CLUTCH SHAFTS

NEWSTAR #:	REPLACES #:	PRODUCT INFORMATION:
S-19914	483767C1	3000 & 4000 Series 3400, 3600-3900 School Bus Series (May 1997 & Before)  DT466, T444E & 7.3 Engine Models Works w/ 14" & 15 1/2" 2 Plate Clutch
S-20630	2005406C1	5000 & 9000 Series DT466, T444E & VT375 Engine Models
S-21695	476337C2	2000 Series Medium & Heavy Duty 3400, 3600, 3700 & 3800 School Bus Series  4500-4900 Series Medium Duty (May 1997 & Before) DT466, T444E & VT375 Engine Models Length: 8 1/2" Works w/ 14" & 15 1/2" 2 Plate Clutch



S-19914



S-21695



S-20630

## FLYWHEELS

NEWSTAR #	REPLACES #:	APPLICATION:
S-A608	1810855C93	DT466B & C Engine Models
S-10006	1818214C91	7.3L/T444E Engine Models
S-10005	1821915C93	DT466E Engine Models

S-10005

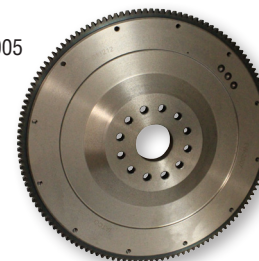

## BEARING & SLEEVE ASSEMBLIES

NEWSTAR #	REPLACES #:	PRODUCT INFORMATION:
S-9208	572107C91	14" & 15" Clutch Assemblies



S-9208

## DRIVE PINS

NEWSTAR #:	REPLACES #:	PRODUCT INFORMATION:
S-7660	697956R2	5000 & 9000 Series DT466, T444E & VT375 Engine Models

S-7660





## ANGLE SPRING STYLE CLUTCH ASSEMBLIES

### THE FOLLOWING ASSEMBLIES ARE EQUIPPED WITH:

- Manual Adjustment
- Greasable Bearing

NEWSTAR #:	DANA #:	COVER #:	PLATE LOAD (LBS.):	TORQUE (FT/LBS.):	CARRIER STYLE:	FRICTION MATERIAL:	CERAMIC CONFIG:	SPRING #:	CONVENTIONAL:	FREE TRAVEL:	MIN. FLYWHEEL OPENING:
<b>14" X 1-3/4" CAST IRON TWO PLATE</b>											
S-8307	C107035-36	C127400-1	3200	600	Round	Organic	—	R	—	—	7"
S-8308	C107035-22	C127400-1	3200	800	Round	Ceramic	—	R	—	—	7"
S-8310	C107035-53	C127400-1	3200	1000	Round	Ceramic	VTL	8	X	—	7"
S-E352	C107063-59	C127400-1	3200	1150	4-Paddle	Ceramic	VSR	8	X	—	7"
<b>14" X 2" CAST IRON TWO PLATE</b>											
S-8304	C107034-19	C127390-1	3200	800	Round	Ceramic	VTL	R	—	—	7"
S-8305	C107034-32 C107034-54B	C127390-1	3200	1000	Round	Organic	—	8	X	—	7"
S-8306	C107034-53	C127390-1	3200	1000	Round	Ceramic	VTL	8	X	—	7"
S-E353	C107050-59	C127390-1	3200	1400	4-Paddle	Ceramic	VSR	8	—	X	7"
<b>15 1/2" X 1-3/4" CAST IRON TWO PLATE</b>											
S-8314	C107090-52	C127476-1	3200	1250	Round	Ceramic	VTL	8	X	—	7"
<b>15 1/2" X 2" CAST IRON TWO PLATE</b>											
S-8318	C107091-52	127597-1	3600	1150	Round	Ceramic	VTL	8	X	—	7"
S-E416	C107391-93	127597-6	4000	1850	6-Paddle	Ceramic	VSR	10	X	—	8.5"
S-E419	C107935-51	150698-4-M	3600	1650	4-Paddle	Ceramic	VSR	9	X	—	10"
S-E603	C107091-81	—	3600	1400	4-Paddle	Ceramic	VSR	8	—	X	7"
S-E606	C107391-74	—	3600	1650	4-Paddle	Ceramic	VSR	10	X	—	8.5"
<b>14" X 1-1/2" STAMPED STEEL SINGLE PLATE</b>											
S-8295	C107688-7	C129710-3	2400	520	4-Paddle	Ceramic	VSR	8	X	—	7"
<b>14" X 1-3/4" STAMPED STEEL SINGLE PLATE</b>											
S-8296	C107113-7	C127747-2	2800	445	Round	Ceramic	VSR	8	X	—	7"
S-8297	C107113-5	C127747-2	2800	650	4-Paddle	Ceramic	VSR	8	X	—	7"
S-E432	C107683-5	C127747-1	3200	650	3-Paddle	Ceramic	VTL	8	X	—	7"
S-E433	C107683-16	C127747-1	3200	445	Round	Organic	—	8	X	—	7"
S-E434	C107684-6	C129044-1	3200	650	3-Paddle	Ceramic	VTL	8	X	—	7"
<b>14" X 1-3/4" STAMPED STEEL TWO PLATE</b>											
S-8299	C107137-5	C129044-2	2800	900	3-Paddle	Ceramic	VSR	8	X	—	7"
S-8298	C107137-6	C129044-2	2800	800	Round	Organic	—	8	X	—	7"
S-C580	C107237-8	C129060-5	2000	900	3-Paddle	Ceramic	VTL	8	—	X	7"
S-E430	C107137-8	C129044-5	2000	900	3-Paddle	Ceramic	VTL	8	—	X	7"
S-E599	C107237-16	C129060-2	2800	800	Round	Organic	—	8	X	—	7"
<b>14" X 2" STAMPED STEEL TWO PLATE</b>											
S-8302	C107142-2	C129055-2	2800	900	3-Paddle	Ceramic	VSR	8	X	—	7"
S-E600	C107342-11	C129061-5	2000	900	3-Paddle	Ceramic	VTL	8	—	X	7"

### THE FOLLOWING ASSEMBLIES ARE EQUIPPED WITH:

- Adjustment Free
- Lube Free Bearing
- Torque 520 ft/lbs
- 3 Paddle Carrier Style
- Ceramic Friction Material
- 8 Springs
- 7" Minimum Flywheel Opening

NEWSTAR #:	DANA #:	COVER #:
<b>365MM STAMPED STEEL</b>		
S-20128	C104100-1	C138006-1
S-20129	C104100-2	C138006-1
S-20130	C104200	C138006-1



S-20128

All parts supplied are S&S Truck Parts Inc./NEWSTAR. Use of other manufacturer's names, part numbers, or trademarks are solely used for informational/identification purposes.

## ANGLE SPRING STYLE CLUTCH ASSEMBLIES

THE ASSEMBLIES BELOW ARE EQUIPPED WITH:

- External Adjustment
- Greasable Bearing
- Conventional
- 7" Minimum Flywheel Opening

NEWSTAR #:	DANA #:	COVER #:	PLATE LOAD (LBS):	TORQUE (FT/LBS):	CARRIER STYLE:	FRICTION MATERIAL:	CERAMIC CONFIG:	SPRING #:
<b>30mm X 1-1/4" &amp; 1 3/8" &amp; 1 1/2"</b>								
S-8853	C107606-1	C330-1928	2800	400	4-Paddle	Ceramic	VTL	8
<b>14" DLB X 1 1/2" &amp; 1 3/4"</b>								
S-E425	LP1047-134	LP14-1047	3200	500	Round	Organic	—	10
S-E426	LP1067-144	LP14-1067	2800	550	Round	Organic	—	10
S-E427	LP1072-134	LP14-1072	2800	550	Round	Organic	—	10
<b>350mm X 1 1/2" SINGLE PLATE PUSH TYPE</b>								
S-C372	C107620-1	C102048	2400	500	4-Paddle	Ceramic	VSR	8
S-E429	C107621-7	C102048	2400	500	4-Paddle	Ceramic	VSR	8

## SOFT PEDAL CLUTCH ASSEMBLIES

THE ASSEMBLIES BELOW ARE EQUIPPED WITH:

- Strap Drive For Smoother Transfer Of Energy
- 30% Less Bearing Load With Pedal Pressure Reduction
- Less Driver Fatigue & Improved Productivity
- Increased Cover Ventilation For Better Heat Dissipation
- State-Of-The-Art Diaphragm Spring Design
- Traditional Manual Adjustment
- Smoother Engagement, No Metal Wear To Cause Internal Friction

The Most Complete Line of New Clutches for Class 6, 7 & 8 Trucks Available in the Aftermarket

- Matched Unit Configurations to Fit Your Needs Up to the Highest Torque Rated Engine Models
- All Makes Coverage for North American Produced Class 6, 7 & 8 Vehicles
- 1 Year, 100,000 Mile Warranty

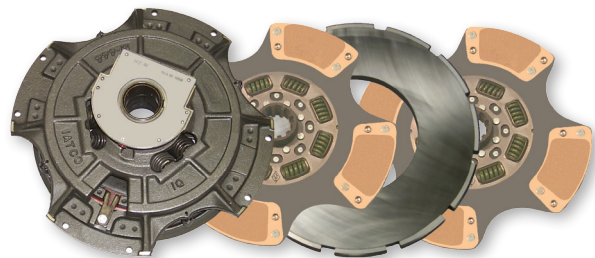

NEWSTAR #:	OEM #:	COVER ASSEMBLY:	ADJUSTMENT TYPE:	BEARING TYPE:	PLATE LOAD (LBS.):	TORQUE (FT/LBS.):	CARRIER STYLE:	FRICTION MATERIAL:	CERAMIC CONFIG:	SPRING #:	MIN. FLYWHEEL OPENING:
<b>14" X 1 3/4" SOFT PEDAL</b>											
S-E437	C108063-59	C160054-1	Manual	Greasable	3200	1150	4-Paddle	Ceramic	VSR	8	7"
<b>14" X 2" SOFT PEDAL</b>											
S-D574	C108050-59	C160051-1	Manual	Greasable	3200	1400	4-Paddle	Ceramic	VSR	8	7"
S-E439	C108950-59	C160051-1	Manual	Greasable	3200	1400	4-Paddle	Ceramic	VSR	8	7"
S-D575	C108034-61	C160051-1	Manual	Greasable	3200	1150	3-Paddle	Ceramic	VSR	8	7"
<b>15 1/2" X 2" SOFT PEDAL</b>											
S-E440	C108391-82	C152705-6	Manual	Greasable	4000	1350	Round	Organic	—	8	7"
S-C307	C108391-77	C152705-4	Manual	Greasable	3600	1250	Round	Organic	—	8	7"
S-C308	C108391-78	C152705-6	Manual	Greasable	4000	1400	Round	Organic	—	10	8.5"
S-C309	C108391-81	C152705-4	Manual	Greasable	3600	1450	4-Paddle	Ceramic	VSR	8	8.5"
S-C310	C108391-74	C152705-4	Manual	Greasable	3600	1650	4-Paddle	Ceramic	VSR	10	8.5"
S-E441	C108391-93	C152705-6	Manual	Greasable	4000	1810	6-Paddle	Ceramic	VSR	10	10"
S-13309	C108925-10	C151455-6	Manual	Greasable	4000	2050	4-Paddle	Ceramic	VSR	6	10"
S-C311	C108925-82 C208925-82	C151455-4	Manual	Greasable	3600	1700	4-Paddle	Ceramic	VSR	7	10"
S-E442	C108935-51	C151455-4	Manual	Greasable	3600	1700	6-Paddle	Ceramic	VSR	9	10"
S-C697	C108935-91 C208925-91	C151455-4	Manual	Greasable Dual Zerk	3600	1700	6-Paddle	Ceramic	VSR	9	10"
S-E443	C108935-94 C208925-94	C151455-6	Manual	Greasable Dual Zerk	4000	1850	6-Paddle	Ceramic	VSR	9	10"

All parts supplied are S&S Truck Parts Inc./NEWSTAR. Use of other manufacturer's names, part numbers, or trademarks are solely used for informational/identification purposes.

## HEAVY DUTY-EASY EFFORT CLUTCH ASSEMBLIES

- Easy effort clutches follow the latest production design using coil spring technology
- Three assist springs serve to lower bearing load, lowering pedal effort
- Adjustment is through the reliable "Spring-a-Just" system

NEWSTAR #:	OEM #:	COVER ASSEMBLY:	ADJUSTMENT TYPE:	BEARING TYPE:	PLATE LOAD (LBS.):	TORQUE (FT/LBS.):	CARRIER STYLE:	FRICTION MATERIAL:	CERAMIC CONFIG:	SPRING #:	MIN. FLYWHEEL OPENING:
<b>14" X 1 3/4" EASY EFFORT</b>											
S-18594	108063-59	147800-4	Spring-a-Just	Greasable	3600	1000	Round	Organic		8	7"
S-18595	108063-59EE	147800-1	Spring-a-Just	Greasable	3200	1150	4-Paddle	Ceramic	VSR	8	7"
<b>14" X 2" EASY EFFORT</b>											
S-18598	108034-82EE	147890-4	Spring-a-Just	Greasable	3600	1100	Round	Organic		8	7"
S-18599	108050-59EE	147890-1	Spring-a-Just	Greasable	3200	1400	4-Paddle	Ceramic	VSR	8	7"
S-18600	108034-61EE	147890-1	Spring-a-Just	Greasable	3200	1150	3-Paddle	Ceramic	VSR	8	7"
S-18601	108950-59EE	147890-1	Spring-a-Just	Greasable	3200	1400	4-Paddle	Ceramic	VSR	8	7"
<b>15 1/2" X 1 3/4" EASY EFFORT</b>											
S-18602	108050-59EE	147890-1	Spring-a-Just	Greasable	3200	1400	4-Paddle	Ceramic	VSR	8	7"
<b>15 1/2" X 2" EASY EFFORT</b>											
S-18603	C108391-74EE	C157898-4	Spring-a-Just	Greasable	3600	1650	4-Paddle	Ceramic	VSR	10	8.5"
S-18604	C108391-77EE	C157898-4	Spring-a-Just	Greasable	3600	1250	Round	Organic		8	7"
S-18605	C108391-78EE	C157898-6	Spring-a-Just	Greasable	4000	1400	Round	Organic		10	8.5"
S-18606	C108391-81EE	C157898-4	Spring-a-Just	Greasable	3600	1450	4-Paddle	Ceramic	VSR	8	7"
S-18607	C108391-82EE	C157898-6	Spring-a-Just	Greasable	4000	1350	Round	Organic		8	7"
S-18609	C108391-93EE	C157898-6	Spring-a-Just	Greasable	4000	1810	6-Paddle	Ceramic	VSR	10	8.5"
S-21811	C108925-20EE 208925-20EE	C157898-6	Spring-a-Just	Greasable	4000	1860	6-Paddle	Ceramic	VSR	7	10"
S-18611	C108925-20EE 208925-25EE	C157898-6	Spring-a-Just	Greasable	4000	2050	6-Paddle	Ceramic	VSR	6	10"
S-21888	C108937-32EE	C157898-8	Spring-a-Just	Greasable	4200	2250	6-Paddle	Ceramic	VSR	6	10"
S-18612	C108925-70EE 208925-70EE	C157898-6	Spring-a-Just	Greasable	4000	1750	6-Paddle	Ceramic	VSR	7	10"
S-18613	C108925-82EE 208925-82EE	C157898-4	Spring-a-Just	Greasable	3600	1700	4-Paddle	Ceramic	VSR	7	10"
S-18614	C108935-26EE 208925-25EE	C157898-6	Spring-a-Just	Greasable Dual Zerk	4000	1700	6-Paddle	Ceramic	VSR	6	10"
S-18615	C108935-51EE 208925-51EE	C157898-4	Spring-a-Just	Greasable Dual Zerk	3600	1700	4-Paddle	Ceramic	VSR	9	10"
S-18616	C108935-82EE 208925-82EE	C157898-4	Spring-a-Just	Greasable Dual Zerk	3600	1700	4-Paddle	Ceramic	VSR	7	10"
S-18617	C108935-91EE 208925-91EE	C157898-4	Spring-a-Just	Greasable Dual Zerk	3600	1700	6-Paddle	Ceramic	VSR	9	10"
S-18618	C108935-94EE 208925-94EE	C157898-6	Spring-a-Just	Greasable Dual Zerk	4000	1850	6-Paddle	Ceramic	VSR	9	10"
S-E420	107935-E2EE	C150649-4-M	Spring-a-Just	Greasable	3600	1700	4-Paddle	Ceramic	VSR	7	10"
S-21740	C108935-15	C150699-4-M	Spring-a-Just	Greasable Dual Zerk		2050	6-Paddle	Ceramic	VSR		10"

All parts supplied are S&S Truck Parts Inc./NEWSTAR. Use of other manufacturer's names, part numbers, or trademarks are solely used for informational/identification purposes.

## CLUTCH INSTALLATION KITS

DRIVETRAIN

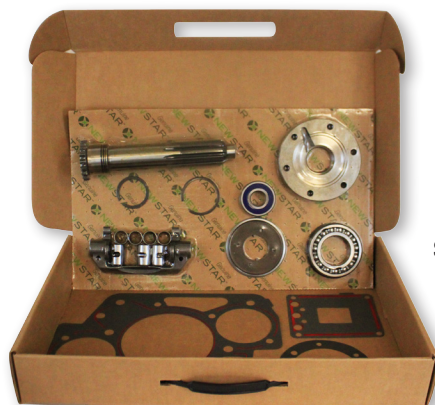

S-9971

NEWSTAR #:	REPLACES #:	DESCRIPTION:	PRODUCT INFORMATION:
S-9971	FUL K-2468	Clutch Installation Kit	Works w/ Fuller Heavy Duty Applications w/ 2" Clutch

**CONSISTS OF:**

NEWSTAR #:	REPLACES #:	DESCRIPTION:
S-15330	—	Gasket Set
S-5761	12815	Bushing
S-4596	14750	Snap Ring
S-9063	16980	Snap Ring
S-4312	20550	Retainer
S-16421	5566505	Pilot Bearing
S-A018	81504	Cylindrical Bearing
S-7440	85533	Clutch Fork
S-B039	85535	Torque Limiting Brake
S-5501	8677	Bushing
S-6519	S-1659	Input Shaft Assembly

**CLUTCH INSTALLATION KIT FEATURES:**

New kits now available for Fuller FR series. Also contains Mack application pilot bearing  
 New idle shaft design engineered to eliminate idle gear rattle  
 Latest design shift tower & clutch housing gaskets - includes beaded surface to eliminate leak paths  
 Includes latest design front bearing cover engineered for smoother clutch brake  
 Surface w/ oil return grooves on the input shaft for maximum lube retention  
 Many kits contain long life flywheel pilot bearing w/ high temperature grease & viton seals to resist the temperatures of today's hotter running engines  
 Some kits include the cross shaft bushings for improved throw-out bearing life, smoother shifting, easier operation & protection against costly clutch housing repairs or replacements

All parts supplied are S&S Truck Parts Inc./NEWSTAR. Use of other manufacturer's names, part numbers, or trademarks are solely used for informational/identification purposes.

## CLUTCH INSTALLATION KITS



S-15476

NEWSTAR #:	REPLACES #:	DESCRIPTION:	PRODUCT INFORMATION:
S-15476	K-3600	Clutch Installation Kit	Works w/ Fuller FR Heavy Duty Transmissions w/ 2" Clutch
<b>CONSISTS OF:</b>			
NEWSTAR #:	REPLACES #:	DESCRIPTION:	
S-13912	14311	Gasket	
S-E330	4304815	Gasket	
S-5761	12815	Bushing	
S-A726	4303431	Gasket w/Silicone	
S-9063	16980	Snap Ring	
S-13948	4303362	Snap Ring	
S-11966	4301417	Cylindrical Bearing	
S-4312	20550	Retainer	
S-16421	5566505	Pilot Bearing	
S-7440	85533	Clutch Fork	
S-B039	85535	Torque Limiting Brake	
S-E911	S-2822	Input Shaft	

## ADDITIONAL DRIVETRAIN COMPONENTS

NEWSTAR #:	REPLACES #:	DESCRIPTION:	PRODUCT INFORMATION:
S-23013	994346	Seal Kit	Works w/ all DriveMaster® Fan Clutches
S-17180	1657064C91	Oil Seal Kit	9072, 1372A, B, PS125, 140-7, PS97-7, PS9 & 10



NEWSTAR #:	REPLACES #:	DESCRIPTION:
S-21611	1830858C1	Liquid Gasket



NEWSTAR #:	REPLACES #:	DESCRIPTION:	PRODUCT INFORMATION:
S-22012	2591985C91	Axle Shaft Mounting Kit	4000 Series Medium Duty 7000 Series Severe Duty 9000 Series Premium Conventionals 3000, 3800, FE300, RE300, CE200 & 300 School Bus Series Includes NL112-1 (3620312C1)



All parts supplied are S&S Truck Parts Inc./NEWSTAR. Use of other manufacturer's names, part numbers, or trademarks are solely used for informational/identification purposes.



## RADIATORS

NEWSTAR #:	REPLACES #:	PRODUCT INFORMATION:
<b>S-23036</b>	1102254 VAB1050166 VAB1102254	UPS/Fedex Step Vans, Workhorse & Multiple Thomas School Bus Models Core Dimensions: 27 7/16" X 25 1/8" X 2 1/16" Inlet/Outlet: 2.0/2.0



NEWSTAR #:	REPLACES #:	PRODUCT INFORMATION:
<b>S-23033</b>	1102431AS VAB1102431 1003671	Thomas School Bus Models Core Dimensions: 29 5/8" X 25 9/16" X 2 1/16" Inlet/Outlet: 2.0/2.0



NEWSTAR #:	REPLACES #:	PRODUCT INFORMATION:
<b>S-17264</b>	1668901C91	1600, 1700, 4600 & 4900 Series Medium Duty (1978-1993) Core Dimensions: 31" x 26" x 2.5" Inlet/Outlet: 2.5/2.5 Copper Brass w/ Oil Cooler

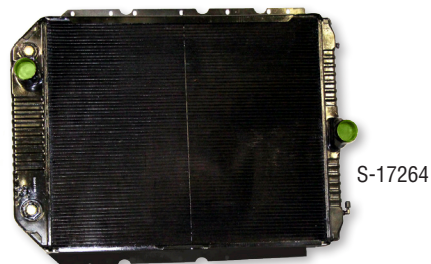

NEWSTAR #:	REPLACES #:	PRODUCT INFORMATION:
<b>S-16536</b>	1697273C1	3800 & 4700 Series Medium Duty (1997-2001) 4900 Series w/ DT466 or Cummins C10 Engine Models Core Dimensions: 31" x 12.75" x 2.5" Inlet/Outlet: 2.5/2.5 Copper Brass

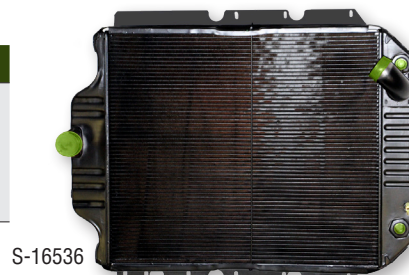

NEWSTAR #:	REPLACES #:	PRODUCT INFORMATION:
<b>S-20474</b>	1697743C2	3800 & 4900 Series Medium Duty (1993-1996) Core Dimensions: 31" x 12 3/4" x 2 1/16" Inlet/Outlet: 2.5/2.5



NEWSTAR #:	REPLACES #:	PRODUCT INFORMATION:
<b>S-16538</b>	2000985C91	4700, 4900 & 8000 Series Medium Duty (1978-2002) Core Dimensions: 29.75" x 26" x 2.5" Inlet/Outlet: 2.5/2.5 Copper Brass w/ Oil Cooler

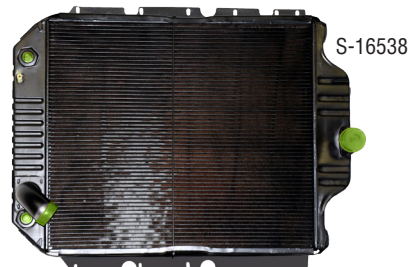

All parts supplied are S&S Truck Parts Inc./NEWSTAR. Use of other manufacturer's names, part numbers, or trademarks are solely used for informational/identification purposes.

## RADIATORS



S-20465

NEWSTAR #:	REPLACES #:	PRODUCT INFORMATION:
S-20465	2500917C91	3800 & 4900 School Bus Series (1994-2002)  Core Dimensions: 31" x 12.75" x 2.5" Inlet/Outlet: 2.5/2.5 Copper Brass w/ Oil Cooler

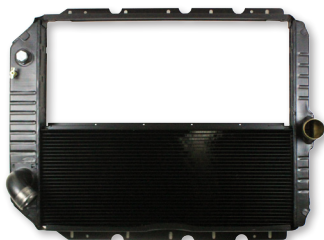

S-16535

NEWSTAR #:	REPLACES #:	PRODUCT INFORMATION:
S-16535	2502718C1	3000, 3600, 3800 School Bus Series (2000-2002)  Core Dimensions: 31" x 12.75" x 2.25" Inlet/Outlet: 2.25/2.25 Copper Brass



S-20472

NEWSTAR #:	REPLACES #:	PRODUCT INFORMATION:
S-20472	2504903C91	3000 & 4000 Series Medium Duty (2002-2007) Ford F650, F700 & F750 Models (2004-2007) Core Dimensions: 20.625" x 25" x 2.25" Inlet/Outlet: 2.25/2.25 Plastic Aluminum w/ Oil Cooler



S-22642

NEWSTAR #:	REPLACES #:	PRODUCT INFORMATION:
S-22642	2504905C92	4100-4400 Series Medium Duty Core Dimensions: 20 <sup>5</sup> / <sub>8</sub> " x 25" x 1 <sup>3</sup> / <sub>4</sub> " Inlet/Outlet: 2.5/2.5 Plastic & Aluminum



S-20062

NEWSTAR #:	REPLACES #:	PRODUCT INFORMATION:
S-20062	2505157C1	4700 Series Medium Duty 3300 School Bus Series  Core Dimensions: 27" x 13 <sup>1</sup> / <sub>8</sub> " x 2 <sup>1</sup> / <sub>16</sub> " Inlet/Outlet: 2.5/2.25 Plastic & Aluminum

All parts supplied are S&S Truck Parts Inc./NEWSTAR. Use of other manufacturer's names, part numbers, or trademarks are solely used for informational/identification purposes.

## RADIATORS

NEWSTAR #:	REPLACES #:	PRODUCT INFORMATION:
<b>S-16537</b>	2505159C91	3000, 3600, 3800, 4100, 4400, 7300 & 7700 Series Medium Duty Core Dimensions: 30.625" x 13.125" x 2.5" Inlet/Outlet: 2.5/2.5 Copper Brass w/ Oil Cooler



NEWSTAR #:	REPLACES #:	PRODUCT INFORMATION:
<b>S-20737</b>	2508454C91	Multiple Series Heavy Duty Core Dimensions: 33 5/8" x 28 1/8" x 2 1/16" Inlet/Outlet: 2.5/2.5 Plastic & Aluminum



NEWSTAR #:	REPLACES #:	PRODUCT INFORMATION:
<b>S-22643</b>	2509895C2	5500-5600 Series Conventionals Core Dimensions: 29 3/8" x 32 1/8" x 2 3/16" Inlet/Outlet: 2.5/2.5 Plastic & Aluminum



NEWSTAR #:	REPLACES #:	PRODUCT INFORMATION:
<b>S-16534</b>	2585978C91	2000, 2500, 2600, 5000, 5500, 5500I, 5600, 5600I, 5900, 5900I, 7300, 7700, 8200, 8300, 9100-9400 & 9900 Series (1993-2006) Core Dimensions: 41" x 28" x 2.2" Inlet/Outlet: 2.5/2.5 Plastic & Aluminum

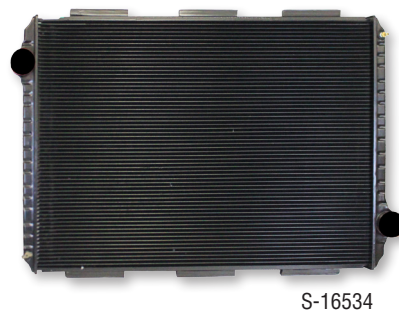

NEWSTAR #:	REPLACES #:	PRODUCT INFORMATION:
<b>S-22644</b>	2591559C91	7600 & 7700 Series Core Dimensions: 40 3/16" x 26 3/16" x 1 7/8" Inlet/Outlet: 2.5/2.5 Plastic & Aluminum

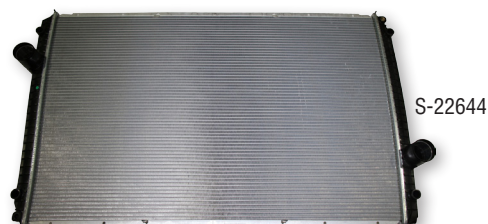

All parts supplied are S&S Truck Parts Inc./NEWSTAR. Use of other manufacturer's names, part numbers, or trademarks are solely used for informational/identification purposes.

## RADIATORS

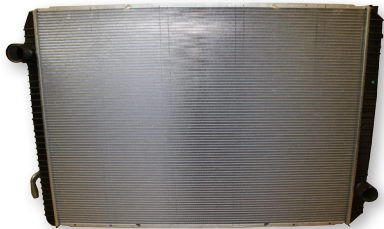

S-22645

NEWSTAR #:	REPLACES #:	PRODUCT INFORMATION:
S-22645	2592331C91	7600 & 7700 Series Core Dimensions: 50" x 33 1/2" x 2 1/4" Inlet/Outlet: 2.5/2.5 Plastic & Aluminum

NEWSTAR #:	REPLACES #:	PRODUCT INFORMATION:
S-23044	2593-295-C91 2593-294-C91 2593-303-C91	4100-4400 Series Medium Duty (2008-2011) BE200, CE200 & 300 School Bus Series (2008-2010)  Core Dimensions : 28 3/4" X 26 1/4" X 2 1/4" Inlet/Outlet: 2.25/2.25

S-20473



NEWSTAR #:	REPLACES #:	PRODUCT INFORMATION:
S-20473	3527216C91	3000, 3600 & 3800 School Bus Series (2000-2002)  Core Dimensions: 31" x 12.75" x 2.25" Inlet/Outlet: 2.25/2.25 Copper Brass w/ Oil Cooler



S-D629

NEWSTAR #:	REPLACES #:	PRODUCT INFORMATION:
S-D629	493349C2	1600, 1700, 4600 & 4900 Series Medium Duty (1978-1995) Core Dimensions: 31" x 26" x 2.5" Inlet/Outlet: 2.5/2.5 Copper Brass



S-D630

NEWSTAR #:	REPLACES #:	PRODUCT INFORMATION:
S-D630	493359C2	1600 & S2100 School Bus Series (1975 -1985)  Core Dimensions: 31" x 25.375" x 2.5" Inlet/Outlet: 2.5/2.5 Copper Brass

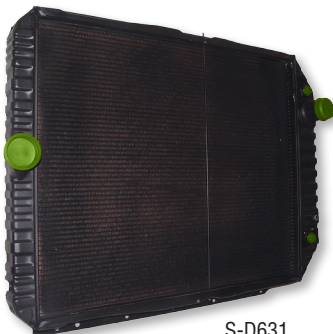

S-D631

NEWSTAR #:	REPLACES #:	PRODUCT INFORMATION:
S-D631	493367C1	2300, 3000, 3600, 3800 & 4000 Series Medium Duty Core Dimensions: 31" x 26.25" x 2.5" Inlet/Outlet: 2.5/2.5 Copper Brass w/ Oil Cooler

All parts supplied are S&S Truck Parts Inc./NEWSTAR. Use of other manufacturer's names, part numbers, or trademarks are solely used for informational/identification purposes.



## RADIATOR COMPONENTS

NEWSTAR #:	REPLACES #:	DESCRIPTION:	PRODUCT INFORMATION:
<b>S-21185</b>	503401C2	Radiator Mount	3000, RE & Amtram School Bus Series  5000, 5500I, 5600I & 5900I Severe Duty Conventionals 9100, 9200, 9400, 9800 & 9900 Series Premium Conventionals



NEWSTAR #:	REPLACES #:	DESCRIPTION:	PRODUCT INFORMATION:
<b>S-6031</b>	506017C1 2504714C1	Radiator Cap	4000 & S Series Medium Duty DT360 Engine Models w/ Auto. Trans. Pressure Rating: 10 lbs



## CHARGE AIR COOLERS

NEWSTAR #:	REPLACES #:	PRODUCT INFORMATION:	MATING COMPONENTS
<b>S-19886</b>	1646077C1 NV8A 6-1131 1E 3486 1E3488G	3000154C1 17V9701 4401-3504 441187	3000 & 4000 Series Medium Duty Core Dimensions: 23.06" x 29.69" x 1.63" Inlet/Outlet: 3.5/3.5



NEWSTAR #:	REPLACES #:	PRODUCT INFORMATION:	MATING COMPONENTS
<b>S-19957</b>	1696920C1 1659054C1 1659055C1 1696955C1 1696956C1 9107001 1030035	3000, 4000, Class 6 & S Series Core Dimensions: 22.82" x 12.56" x 2.76" Inlet/Outlet: 3.0/3.0	 <b>CLAMP</b> (S-20530) Replaces: 2312201250



NEWSTAR #:	REPLACES #:	PRODUCT INFORMATION:
<b>S-19951</b>	1696958C1 2002583C1 1E3738	5000 Series w/ Cat 3406 or Detroit Diesel 60 Series Core Dimensions: 27" x 19.46" x 2.76" Inlet/Outlet: 4.0"/4.0"

### MATING COMPONENTS



All parts supplied are S&S Truck Parts Inc./NEWSTAR. Use of other manufacturer's names, part numbers, or trademarks are solely used for informational/identification purposes.



## CHARGE AIR COOLERS



S-19952



S-19929



S-21742



S-19953

NEWSTAR #:	REPLACES #:	PRODUCT INFORMATION:
<b>S-19952</b>	2004399C1 2005432C1 1E3594 1E3595 1E3595G 1698844C1 1E4151	8200 & 9400 Heavy Duty Series Core Dimensions: 41 1/4" x 24 11/16" x 1 5/8" Inlet/Outlet: 4.0/4.0
<b>S-19929</b>	2508432C1 2587235C1 00637606	9200I Eagle Models Core Dimensions: 41.25" x 24.68" x 1.63" Inlet/Outlet: 4.0/4.0
<b>S-21742</b>	2596587C91 2591600C91	9200, 9400, 9900 & Prostar Linehaul Models Core Dimensions: 39 5/8" x 3 3/4" x 11 1/5" Inlet/Outlet: 4.0/4.0
<b>S-19953</b>	1651980C1 1674003C1 1685578C1 1001921 1030055	9300, 9670, 9700 Blue Bird or Spartan Models w/ Cat 3406 or Cummins N14 Engine Models Core Dimensions: 27.00" x 19.46" x 2.76" Inlet/Outlet: 4.0/4.0

### MATING COMPONENTS

	<b>HOSE</b> (S-21358) Replaces: FRE 1020-00001		<b>HOSE</b> (S-16104) Replaces: 673866C1 2014134C2		<b>CLAMP</b> (S-9414) Replaces: 1674053C1
--	---	---	--	--	--

NEWSTAR #:	REPLACES #:	PRODUCT INFORMATION:
<b>S-23793</b>	2604-296-C	Prostar Linehaul Conventionals Core Dimensions : 36 7/16" X 20 5/16" X 2" Inlet/Outlet: 4.0/3.0

## TURBO CHARGERS



S-20995



NEWSTAR #:	REPLACES #:	PRODUCT INFORMATION:
<b>S-20995</b>	3804502	Cummins N14 Engine Models

## TURBO HOSES



S-21358





S-16104

NEWSTAR #:	REPLACES #:	PRODUCT INFORMATION:
<b>S-21358</b>	FRE 1020-00001	Multiple School Bus Applications  Dimensions: 4" x 6 1/2" Cold Air Return
<b>S-16104</b>	1673866C1 2014134C2	Multiple School Bus Applications  Detroit 60, Cat3406 & Cummins M11 Engine Models Dimensions: 4" x 7" Warm Air Return

All parts supplied are S&S Truck Parts Inc./NEWSTAR. Use of other manufacturer's names, part numbers, or trademarks are solely used for informational/identification purposes.

### TURBO CLAMPS



NEWSTAR #:	REPLACES #:	DIMENSIONS:	APPLICATION:
S-4675	338614C1	ID: 3 1/2"	Multiple School Bus Applications 
S-9414	1674053C1	ID: 4 1/8"-4 7/16"	Multiple School Bus Applications 
S-5222	1672105C91 3586939C1	ID: 5"	Multiple School Bus Applications 
S-7537	ZFS89533K	ID: 4"	Multiple School Bus Applications 
S-22013	1824400C1	—	4100 & 4200 Series Medium Duty 3000, 3300, 3600, 3800 Models Amtran, BE, CE, RE200 & 300 School Bus Series 
S-21725	3519061C1	ID: 2 1/2"	2500 & 2600 Heavy Duty Models

### OIL COOLERS

NEWSTAR #:	REPLACES #:	PRODUCT INFORMATION:
S-20069	1815904C2	DT466 (1994-2003) & T444E (1995-2003) Engine Models FE, IC, RE, 3000, 3600 & 3800 School Bus Series (May 1997 & Up)  4000 Series Medium Duty 5000 Series Severe Duty



### EGR COOLERS



NEWSTAR #:	REPLACES #:	REPLACEMENT FOR BEHR #	REPLACEMENT FOR CUMMINS #	PRODUCT INFORMATION:
S-23049	4089380NX	376905-031	—	Cummins ISM (2007-2009) & ISM 10.8 Engine Models Multiple Applications (2002-2006) ID: 1.4" Includes Install Kit S-22741
S-23050	4956008NX	376905-041	3683253 3683435 4952490 2869133 2878071	Cummins ISX Engine Models (2002-2006) Cummins ISX 15.0 Engine Models Multiple Applications (2003-2006) ID: 1.4"

All parts supplied are S&S Truck Parts Inc./NEWSTAR. Use of other manufacturer's names, part numbers, or trademarks are solely used for informational/identification purposes.

## EGR COMPONENTS

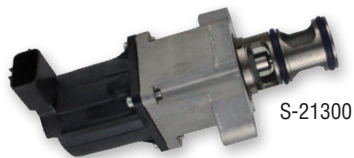

S-21300

NEWSTAR #:	REPLACES #:	DESCRIPTION:	PRODUCT INFORMATION:
<b>S-21300</b>	1846296C91	EGR Valve	VT365 Engine Models (2004-2006) 4100 & 4200 Series Medium Duty BE200, CE200, 300 & RE300 School Bus Series 

## SURGE TANKS



S-4896



S-7890



S-8997



S-21945

NEWSTAR #	REPLACES #:	PRODUCT INFORMATION:
<b>S-4986</b>	586531C3	1600-1900 & 2100 Series Medium Duty
<b>S-8997</b>	1619114C5	Multiple Medium Duty Applications w/o Drain Port in Back
<b>S-7890</b>	1661919C5	Late Model S Series w/o Drain Port
<b>S-21945</b>	2508700C93	5500, 5600 & 5900 Series Severe Duty Conventionals 9200, 9400 & 9900 Series Premium Conventionals Includes 2 Sight Glasses
<b>S-21566</b>	2591625C2	5000, 5500I, 5600I & 5900I Series Severe Duty 9100, 9200, 9400 & 9900 Premium Conventionals

### MATING COMPONENTS



**CAP**  
(S-7625)  
130704R1  
530874R1

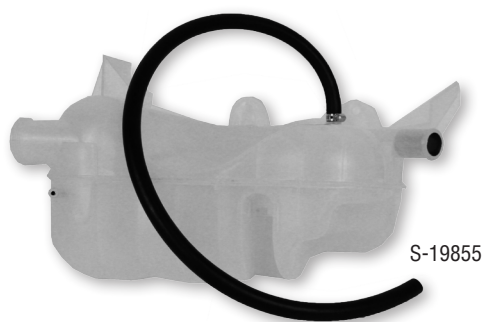

S-19855

NEWSTAR #	REPLACES #:	PRODUCT INFORMATION:
<b>S-19855</b>	2602935C91	BE200, CE200 & 300 School Bus Series  4100-4400 Series Medium Duty

### MATING COMPONENTS



**CAP**  
(S-19039)  
3578833C3

## SURGE TANK CAPS





S-7625



S-19039









S-C118

NEWSTAR #	REPLACES #:	PRODUCT INFORMATION:
<b>S-7625</b>	130704R1 530874R1	4000 & S Series Medium Duty DT360 Engine Models w/ Auto. Trans. Pressure Rating: 10 lbs
<b>S-19039</b>	3578833C3	Multiple School Bus Series  15 PSI
<b>S-C118</b>	2039390C1	4100-4400 Series Medium Duty 3000, CE200 & 300 School Bus Series 

All parts supplied are S&S Truck Parts Inc./NEWSTAR. Use of other manufacturer's names, part numbers, or trademarks are solely used for informational/identification purposes.

## PREFORMED EXHAUST CLAMPS

NEWSTAR #:	REPLACES #:	ID:	PRODUCT INFORMATION:
S-22680	EC30PLA-R	3"	4000 Series Medium Duty Aluminized
S-22681	EC35PLA-R	3 1/2"	4000 Series Medium Duty 3000 Series School Bus Aluminized
S-22682	EC35PLS-R	3 1/2"	4000 Series Medium Duty 3000 Series School Bus Stainless Steel 
S-22683	EC40PLA-R	4"	4000 Series Medium Duty 9000 Series Premium Conventional & Cabover Models Amtram School Bus Series 
S-22684	EC40PLS-R	4"	4000 Series Medium Duty 9000 Series Premium Conventional & Cabover Models Amtram School Bus Series 
S-22685	EC50PLA-R	5"	5000 Series Severe Duty Models 9000 Series Premium Cabover & Conventional Models Aluminized
S-22686	EC50PLS-R	5"	9700 & 9800 Series Premium Cabovers Stainless Steel
S-C110	EC35PLA	3 1/2"	3000 School Bus Series  4000 Series Medium Duty Aluminized
S-8476	EC40PLA FLT40PLA ZFS90356A 583978C91	4"	3000 School Bus Series  4000 Series Medium Duty 9000 Series Premium Cabovers Aluminized
S-D424	EC40PLS	4"	3000 School Bus Series  4000 Series Medium Duty 9000 Series Premium Cabovers Aluminized
S-7687	EC50PLA FLT50PLA XH90358A 583979C91	5"	5000 Series Severe Duty 9000 Series Premium Cabovers Aluminized
S-A999	EC50PLS FRT50PLS ZF590358A	5"	9600 & 9700 Series Premium Cabovers Aluminized
S-21952	3557858C1	—	3000 & RE300 School Bus Series  7000 Series Severe Duty 9200, 9400 & 9900 Series Premium Conventionals Prostar Linehaul Conventionals
S-B339	EC30PLS	3"	Works w/ Exhaust Pipe Stainless Steel



All parts supplied are S&S Truck Parts Inc./NEWSTAR. Use of other manufacturer's names, part numbers, or trademarks are solely used for informational/identification purposes.

ENGINE





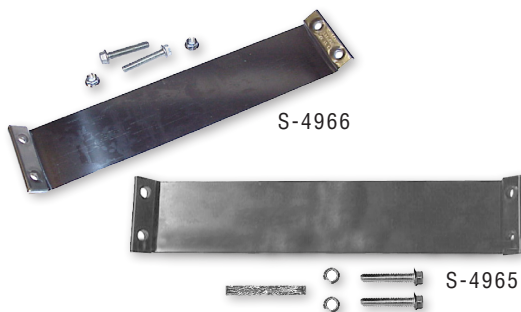









## FLAT BAND JOINT CLAMPS







NEWSTAR #:	REPLACES #:	DIMENSIONS:	APPLICATION:
<b>S-4965</b>	EC40EST 549558C91 ZF589527B	4"	2000 Series Medium & Heavy Duty Stainless Steel
<b>S-4966</b>	EC50EST 549559C91 FLTA50AF ZFS89528B	5"	2000 Series Medium & Heavy Duty Stainless Steel

## ADDITIONAL CLAMPS

NEWSTAR #:	REPLACES #:	DESCRIPTION:	ID:	APPLICATION:	
 S-9414	<b>S-D967</b>	554318C1 XH89548K	U-Bolt Clamp	4"	4000 & 9000 Series Medium Duty
 S-4333	<b>S-4333</b>	554319C1	U-Bolt Clamp	5"	4000 Series Medium Duty 5000 Series Severe Duty 9000 Series Premium
 S-20705	<b>S-A862</b>	XH89549K XH89549K	U-Bolt Clamp	5"	8000 Series Heavy Duty 9800 Premium Models
 S-4333	<b>S-20705</b>	2033978C 2031661C1	V-Band Clamp	3"	3000, 3600, 3800 School Bus Series (May 1997 & Up)  3400 & 3700 School Bus Series (May 1997 & Before)  Amtran RE School Bus Series (Nov 1999 & Before)  4000 Series Medium Duty T444E Engine Models
 S-20705	<b>S-22009</b>	1517672C91	Hose Clamp	4" - 4 1/2"	5000 Series Severe Duty 9000 Series Premium Conventional Prostar Linehaul Conventional Models
 S-20705	<b>S-22010</b>	1616029C1	Hose Clamp	2 1/4" - 3 1/2"	4000 Series Medium Duty 9000 Series Premium Conventionals 3000, Amtran, BE200, CE200, 300 FE300 & RE300 School Bus Series 
 S-20705	<b>S-23256</b>	3553803C2	Clamp	4"	4100, 4300, 4400 & 4700 Series Medium Duty 3000, 3800, BE200, CE200, 300 & FE300 School Bus Series 

## MUFFLER COMPONENTS



NEWSTAR #:	REPLACES #:	DESCRIPTION:	APPLICATION:
<b>S-18484</b>	1660540C91	Muffler Clamp	1000, 4000 & 7000 Medium Duty Series 3000 School Bus Series (May 1997 & Before)  3800 School Bus Series (May 1997 & Up) 
<b>S-13490</b>	2018471C1	Exhaust Muffler	3000 FE, IC School Bus Series  3400, 3600-3800 School Bus (May 1997 & Before)  DT360 & 466E Engine Models Inlet/Outlet: 3.5/4.0

All parts supplied are S&S Truck Parts Inc./NEWSTAR. Use of other manufacturer's names, part numbers, or trademarks are solely used for informational/identification purposes.



## FAN CLUTCHES & BELTS

ENGINE



**FAN BELT**  
S-9731



**FAN BELT**  
S-7664

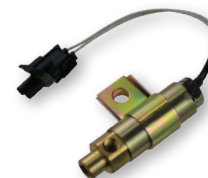

**FAN CLUTCH SOLENOID VALVE**  
S-9084



**FAN CLUTCH**  
S-14677

**FAN CLUTCH REBUILD KIT**  
S-14513



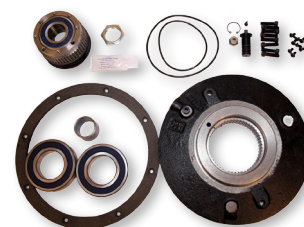

**FAN CLUTCH REBUILD KIT**  
S-14676



**FAN CLUTCH REBUILD KIT**  
S-14030

NEWSTAR #:	REPLACES #:	DESCRIPTION:	DIMENSIONS:	APPLICATION:
S-14699	38713RA	Fan Clutch Rebuild Kit	—	K22R Engine Models
S-14513	ZBH994205	Fan Clutch Rebuild Kit	—	KYSOR K22RA Engine Models
S-14030	ZBH994305	Fan Clutch Rebuild Kit	9.5"	HTS Engine Models
S-14676	ZBH994307	Fan Clutch Rebuild Kit	7.5"	HTS Engine Models
S-14677	2509380C91 2501022C91 2602141C91	Fan Clutch	—	KYSOR K22RA Engine Models
S-9731	2012260C1	Fan Belt	63 1/2"	—
S-7664	11175C91 L17446	Fan Belt	4 39/64"	—
S-9084	1689785C91 1692761C91	Fan Clutch Solenoid Valve	—	4000 Series Medium Duty 5000 Series Severe Duty 9000 Series Premium Conventionals & Cabovers 3000 School Bus Series 

## INJECTOR SEAL KITS

NEWSTAR #:	REPLACES #:	PRODUCT INFORMATION:
S-18777	1833564C92	4000 Series Medium Duty 3000, FE, TC & RE (Nov 1999 & Up) 3400-3900, CE200, CE300 & Amtran School Bus Series  T444E Engine Models
S-22011	1842624C91	4300 & 4400 Series Medium Duty 7000 Series Severe Duty CE200, 300, FE300 & RE300 School Bus Series 
S-21949	1830742C92	DT466E & T444E Engine Models CE200, 300, 3000 & 3800 School Bus Series  4000 Series Medium Duty 7000 Series Severe Duty

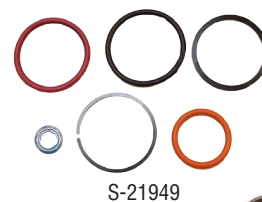

S-21949



S-22011

S-18777

All parts supplied are S&S Truck Parts Inc./NEWSTAR. Use of other manufacturer's names, part numbers, or trademarks are solely used for informational/identification purposes.

## O-RINGS, SEALS & GASKETS



S-19402







S-20517



S-21312



S-19848



NEWSTAR #:	REPLACES #:	DESCRIPTION:	APPLICATION:
S-19848	464751C1	Fuel Sender Gasket	Used w/ All Stewart Warner Design Fuel Senders 3000FE, FE300, Amtran School Bus Series 
S-19402	1807563C1	Oil Cooler O-Ring	2000-5000 Series w/ DT466 Engine Models 3400, 3600-3900 School Bus Series w/ DT466 Engine Models 
S-20517	1817867C93	Rear Engine Seal	FE, IC, RE, 3000 School Bus Series w/ DT466 Engine Models 
S-21312	1822135C1	Breather O-Ring	3400, 3600-3800 School Bus Series w/ Flat Back Cowls  4300, 4400, 4500, 4600 & 4700 Series Medium Duty



S-22706



S-20656

NEWSTAR #:	REPLACES #:	DESCRIPTION:	PRODUCT INFORMATION:
S-20656	1826703C1	Valve Cover Gasket	3000, 3600 & 3800 School Bus Series  4700 Series Medium Duty T44E Engine Models
S-22706	1842380C91	Valve Cover Gasket	4300 & 4400 Series Medium Duty CE200/300 & FE, RE300 School Bus Series  DT466E Engine Models

## ENGINE VALVES & COMPONENTS





S-21726

NEWSTAR #:	REPLACES #:	DESCRIPTION:	PRODUCT INFORMATION:
S-21726	1813892C1	Valve Lifter Guide	2500 & 2600 Series Medium Duty 5000 Series Severe Duty 4000, CE200, 300, 3000, 3400 & 3600-3800 School Bus w/ DT466 Engine Models 



S-17343

NEWSTAR #:	REPLACES #:	DESCRIPTION:	PRODUCT INFORMATION:
S-17343	1841217C91	IPR Valve	Amtran CE200/300 School Bus Series  3000FE, IC, RE School Bus Series (Nov. 1999 & Up)  3600 & 3800 School Bus Series (May 1997 & Up)  DT444E, I530E & 7.3L Engine Models

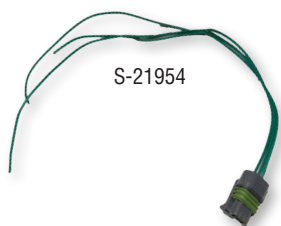

S-21954

NEWSTAR #:	REPLACES #:	DESCRIPTION:	PRODUCT INFORMATION:
S-21954	2501107C1	IPR Pigtail	CE200, 300 & RE300 School Bus Series  4300 & 4400 Series Medium Duty DT466 Engine Models

All parts supplied are S&S Truck Parts Inc./NEWSTAR. Use of other manufacturer's names, part numbers, or trademarks are solely used for informational/identification purposes.

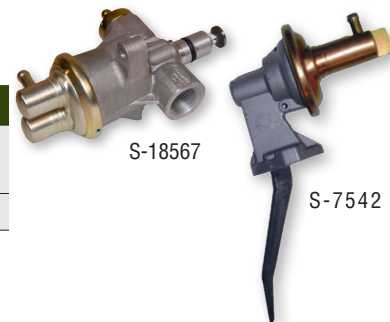

## FUEL PUMPS & COMPONENTS

NEWSTAR #	REPLACES #:	DESCRIPTION:	APPLICATION:
<b>S-18567</b>	1824415C93	Fuel Pump	3000 School Bus Series  DT466E & T444E Engine Models
<b>S-7542</b>	1804495C93	Fuel Pump	6.9 & 7.3L Engine Models



NEWSTAR #:	REPLACES #:	DESCRIPTION:	PRODUCT INFORMATION:
<b>S-23094</b>	1876108C91	Fuel Pump Kit	DT466E/530E Engine Models 4300, 4400, 4900 Series Medium Duty CE200, 300, FE, RE300 School Bus Series  7300-7600 Series Severe Duty



NEWSTAR #	REPLACES #:	DESCRIPTION:	PRODUCT INFORMATION:
<b>S-21018</b>	1824946C1	Hand Primer	2500 & 2600 Heavy Duty Models 4300-4900 Series Medium Duty 5000, 5500I & 5600I Series Severe Duty 3000, FE, IC, RE, CE200 & 300 School Bus Series  3600 & 3800 School Bus Series (May 1997 & Up) 



NEWSTAR #	REPLACES #:	DESCRIPTION:	PRODUCT INFORMATION:
<b>S-21070</b>	1825473C93	Primer Kit	DT466 & DT360 Engine Models 3000 School Bus Series  Includes S-21018 & Mating Brass Cone



## FILTERS

NEWSTAR #	REPLACES #:	DESCRIPTION:	PRODUCT INFORMATION:
<b>S-20654</b>	3532799C1	Air Filter	4100-4400 Series Medium Duty 7300-7500 Series Severe Duty BBE200, CE200, 300, 3200 & 3300 School Bus Series 



All parts supplied are S&S Truck Parts Inc./NEWSTAR. Use of other manufacturer's names, part numbers, or trademarks are solely used for informational/identification purposes.

**FILTERS**



S-21372

NEWSTAR #	REPLACES #:	DESCRIPTION:	PRODUCT INFORMATION:
<b>S-21372</b>	FS19624	Fuel Filter	Detroit 60 Engine Models



SSWF2077

SSFS1000

NEWSTAR #:	REPLACES #:
<b>SSAF1968M</b>	AF1968M
<b>SSAF25139M</b>	AF25139M
<b>SSLF689</b>	LF689
<b>SSFF5052</b>	FF5052
<b>SSFS1000</b>	FS1000
<b>SSFS1212</b>	FS1212
<b>SSLF3620</b>	LF3620
<b>SSLF3970</b>	LF3970
<b>SSLFP9000</b>	LF9000
<b>SSWF2071</b>	WF2071
<b>SSWF2072</b>	WF2072
<b>SSWF2074</b>	WF2074
<b>SSWF2077</b>	WF2077

**OIL CAPS**



NEWSTAR #	REPLACES #:	DESCRIPTION:	PRODUCT INFORMATION:
<b>S-4673</b>	336079R91	Oil Filler Cap	Cargostar, 9670 & S Series Dimensions: 1 1/4"



S-5328

NEWSTAR #	REPLACES #:	DESCRIPTION:	PRODUCT INFORMATION:
<b>S-5328</b>	379318C1	Oil Cap	MU404 & 446 Engine Models



## WATERPUMPS

### FEATURES OF THE PUMPS BELOW:

- New No Core Charge



NEWSTAR #:	REPLACES #:	PRODUCT INFORMATION:
<b>S-4293</b>	685155C94 WP181091 735327C91	DT466A & DT466B Engine Models
<b>S-19612</b>	4089910	ISX Engine Models w/ 12 Rib Pulley
<b>S-14694</b>	3803403	L10 Engine Models M11 Engine Models, 3 Bolt Design
<b>S-D893</b>	3803605	N14 Engine Models
<b>S-E803</b>	1815538C91 WP181366	DT466C Engine Models
<b>S-B473</b>	1817687C96 1830606C93	DT408P, DT466P, DT466E, 1530P & 1530G Engine Models
<b>S-13248</b>	1831676C92 ZWP181693	T444E Engine Models
<b>S-17036</b>	1842664C92 WP181911	DT466E Engine Models (2005 & Up) 530E Engine Models 3000, 3200, 3300, CE200, CE300 & FE300 School Bus Series 
<b>S-22864</b>	1845002C91	Vt365 Engine Models 4100 & 4200 Series Medium Duty BE200, CE200, 300 & RE300 School Buse Series



All parts supplied are S&S Truck Parts Inc./NEWSTAR. Use of other manufacturer's names, part numbers, or trademarks are solely used for informational/identification purposes.



## MOUNTS

### COMPLEMENTARY COMPONENTS

**REAR ENGINE MOUNT**  
S-20818



**REAR ENGINE MOUNT**  
S-20215

NEWSTAR #:	REPLACES #:	PRODUCT INFORMATION:
<b>S-20818</b>	1664730C7	5500I, 5600I & 5900I Series Severe Duty 9200, 9400 & 9900 Series Premiums Prostar Linehaul Conventionals
<b>S-20215</b>	1664729C7	7600, 7700, 5500I, 5600I & 5900I Series Severe Duty 9200, 9400 & 9900 Series Premiums Prostar Linehaul Conventionals



S-3938



S-3777



S-2731



S-D905



S-D906



S-2595

NEWSTAR #:	REPLACES #:	PRODUCT INFORMATION:
<b>S-2595</b>	80445R1	4000, 8000 & 9000 Series
<b>S-3780</b>	200106R1	3000 School Bus Series  4000 Series Medium Duty & 9000 Series Premium Conventionals
<b>S-2888</b>	286324C2	DT466 & CAT 3208 Engine Models Paystar Models
<b>S-2729</b>	470031C2	CAT 3406, Cummins NTC & Detroit Diesel 6V92 & 6L71 Engine Models 1600 & 2200 Series 4000 Series Medium Duty & 9000 Series
<b>S-3938</b>	503579C1	8000 Series Heavy Tractors 9000 Series Premium Conventionals & Cabovers
<b>S-3777</b>	583955C1 479237C1	CAT 3406, 34081, Detroit Diesel 6V92 & 8V92, Cummins L10 & NTC Engine Models 5000 Series Severe Duty & 9000 Series
<b>S-2731</b>	753997C93	CAT 3306, 3406, Detroit Diesel 8V71, 8V92, 6V92, 8V71 & Cummins NTC Engine Models 5000 & 9000 Series
<b>S-D905</b>	1664723C3	3000, 4000, 8000 & 9000 Series
<b>S-D906</b>	1664726C2	3000, 4000, 8000 & 9000 Series

All parts supplied are S&S Truck Parts Inc./NEWSTAR. Use of other manufacturer's names, part numbers, or trademarks are solely used for informational/identification purposes.

## CABLES



S-6034

NEWSTAR #:	REPLACES #:	DESCRIPTION:	APPLICATION:
S-6034	475173C4 475177C3	Accelerator Cable	S Series
S-C396	475174C5	Accelerator Cable	S Series
S-4799	477854C91	Accelerator Cable	Loadstar & Fleetstar Models
S-8327	488499C2 1694880C91	Accelerator Cable	S Series Medium Duty
S-4117	549841C91	Battery Cable	2000 Series Medium Duty (1981-1988)
S-9767	1694952C91	Modulator Cable	4000 & 8000 Series
S-A638	2010529C91	Accelerator Cable	4000 Series

## FUEL SENDERS

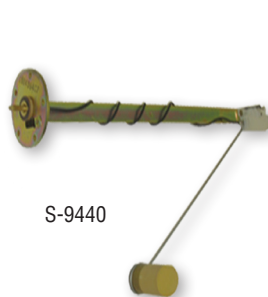

S-9440

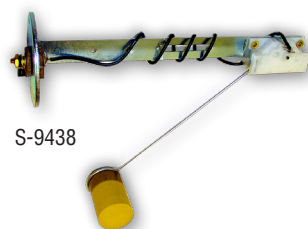

S-9438

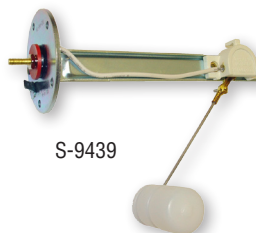

S-9439

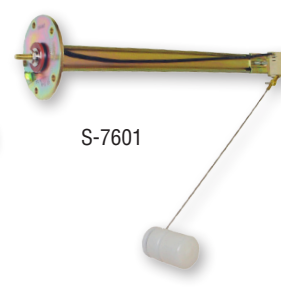

S-7601

NEWSTAR #:	REPLACES #:	PRODUCT INFORMATION:
S-9438	476846C2	8000 & Heavy Duty S Series
S-9439	497840C96	3000FE, IC, RE & 3800 & Amtran School Bus Series 
S-7601	508999C2	9370 & 9670 Models
S-9440	1684364C7	8000 Series

All parts supplied are S&S Truck Parts Inc./NEWSTAR. Use of other manufacturer's names, part numbers, or trademarks are solely used for informational/identification purposes.

## STARTERS



NEWSTAR #:	REPLACES #:	PRODUCT INFORMATION:
S-E225	1990379	12 T Pinion 12 Volt
S-E226	1990483	11 T Pinion 12 Volt
S-16660	10461075 1990428	w/ Over Crank Protection
<b>NEW NO CORE CHARGE</b>		

## ALTERNATORS

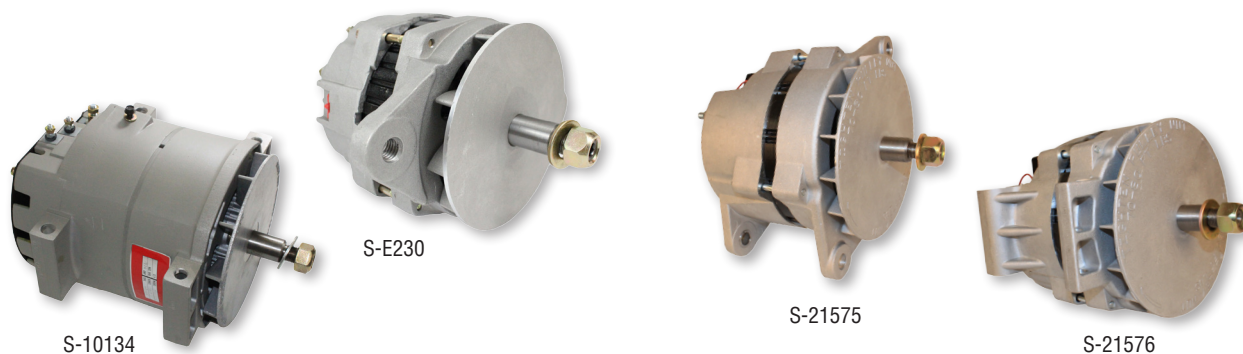

NEWSTAR #:	REPLACES:	DIMENSIONS:	PRODUCT FEATURES:
S-10134	19011176 3540035C91	—	34SI 135 Amp 12 Volt Pad Mount
S-E230	19020302	—	22SI 145 Amp 12 Volt <sup>5</sup> / <sub>16</sub> B+ Term.
S-E232	19020306	—	22SI 145 Amp 12 Volt <sup>1</sup> / <sub>4</sub> B+ Term.
S-21575	110-555HD 8LHA2070VB	<sup>5</sup> / <sub>16</sub> "-24 NF Positive Stud Size <sup>1</sup> / <sub>4</sub> "-28 NF Negative Stud Size <sup>7</sup> / <sub>8</sub> " Shaft Diameter	SAE J-180 Swing Mount 140 Amp 12 Volt External Fan CW
S-21576	110-555P 8LHP2170P	<sup>5</sup> / <sub>16</sub> "-24 NF Positive Stud Size <sup>1</sup> / <sub>4</sub> "-28 NF Negative Stud Size <sup>7</sup> / <sub>8</sub> " Shaft Diameter	140 Amp 12 Volt Pad Mount External Fan CW
S-15369	19020388	—	22SI Pad Mount
<b>NEW NO CORE CHARGE</b>			

## ALTERNATORS COMPONENTS

NEWSTAR #:	REPLACES:	DESCRIPTION:	PRODUCT FEATURES:
S-21946	3539918C1	Alternator Pulley	4700 Series Medium Duty (1997 & Up) 3000, IC, RE, 3800 & Amtran School Bus Series 



All parts supplied are S&S Truck Parts Inc./NEWSTAR. Use of other manufacturer's names, part numbers, or trademarks are solely used for informational/identification purposes.

## GLOW PLUGS

NEWSTAR #:	REPLACES #:	PRODUCT INFORMATION:
S-9715	1804211C2	6.9 Liter Engine Models
S-9261	1807917C1 1819649C1	7.3 Liter Engine Models

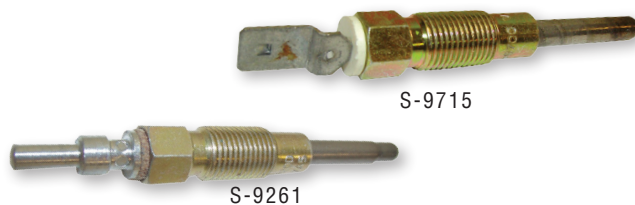

## THERMOSTATS

NEWSTAR #:	REPLACES #:	PRODUCT INFORMATION:
S-22118	1830-256-C93	DT466E Engine Models 3000 & CE200/300 School Bus Series  4000 Series Medium Duty 5000 & 7000 Series Severe Duty 190°
S-22760	1842-130-C3	Ce200, 300, Fe, Re300 4300 & 4400 Series Medium Duty 7300-7500 Series Severe Duty DT466E Engine Models

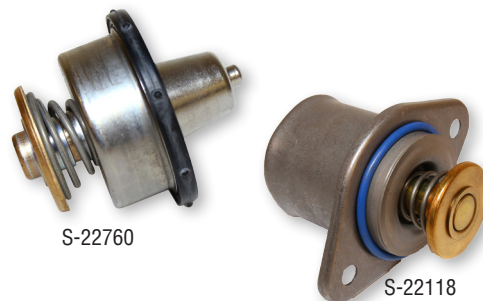

## HARNESSES & COMPONENTS

NEWSTAR #:	REPLACES #:	DESCRIPTION:	PRODUCT INFORMATION:
S-23394	1830844C93	Harness	Fuel Injection/Glow Plug Harness 3000RE, 3600, & 3800 Series T444E Engine Models - Late Generation



NEWSTAR #:	REPLACES #:	DESCRIPTION:	PRODUCT INFORMATION:
S-23396	1889905C91	Harness Injector	3000, 3600, 3800, CE200/300 School Bus Series  4300, 4400, 4700, 4800, & 4900 Series Medium Duty 5000, 5500, 5600, 7300, 7400, 7500 Series Severe Duty 8100 & 8300 Heavy Tractor DT466E, I530E, DT466/530 & HT530 Engine Models

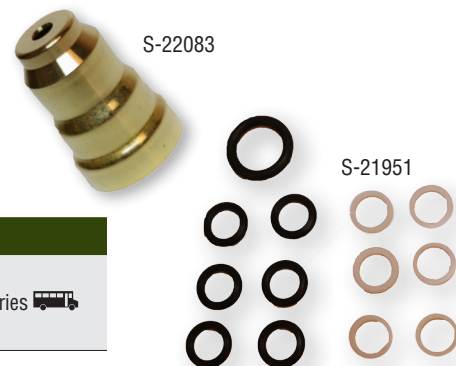

NEWSTAR #:	REPLACES #:	DESCRIPTION:	PRODUCT INFORMATION:
S-22083	1814376C1	Injector Sleeve	T444E Engine Models (1994-2003) 3000 School Bus Series  4000 Series Medium Duty



NEWSTAR #:	REPLACES #:	DESCRIPTION:	PRODUCT INFORMATION:
S-21951	1842626C96	Injector Seal & Ring Kit	DT466E Engine Models 3000, CE200, 300, FE300 & RE300 School Bus Series  7300 - 7600 Severe Service Series

All parts supplied are S&S Truck Parts Inc./NEWSTAR. Use of other manufacturer's names, part numbers, or trademarks are solely used for informational/identification purposes.

## ADDITIONAL ENGINE COMPONENTS

NEWSTAR #:	REPLACES #:	DESCRIPTION:	PRODUCT INFORMATION:
<b>S-19947</b>	1822652C92	Engine Pulley	3000, 3600 & 3800 Models (May 1997 & Up) T444E Engine Models w/ OEM Bearings, Includes NTN 6203C3 Bearing
<b>S-19829</b>	1822653C92	Engine Pulley	3000 IC, RE School Bus Series  3600 & 3800 Models (May 1997 & Up) BE200 & CE200 School Bus Series  T444E Engine Models w/ OEM Bearings, Includes NTN 6203C3 Bearing



S-19947

NEWSTAR #:	REPLACES #:	DESCRIPTION:	PRODUCT INFORMATION:
<b>S-5331</b>	691796C1 1820953C4	Dipstick	DT466B Engine Models



S-5331

NEWSTAR #:	REPLACES #:	DESCRIPTION:	PRODUCT INFORMATION:
<b>S-5966</b>	1804027C2	Cylinder Head Bolt	6.9 Liter, DT444E Engine Models
<b>S-8185</b>	1809058C2	Cylinder Head Bolt	7.3 Liter, DT444E Engine Models



S-5966

S-8185

NEWSTAR #	REPLACES #:	DESCRIPTION:	PRODUCT INFORMATION:
<b>S-19405</b>	1812348C1	$\frac{3}{8}$ " Compression Sleeve	4300-4600, 2500 & 2600 Series Medium & Heavy Duty Amtran, CE200, 300 & 3000 School Bus Series  5000, 5500, 5600 & 7300-7600 Series Severe Duty



S-19405



## DEFROST FANS

### DEFROST FANS ARE EQUIPPED WITH:

- 12 Volt
- CW
- Chrome
- 3 Position Switch: Off/Low/High







NEWSTAR #:	REPLACES #:	DESCRIPTION:	DIMENSIONS:	PRODUCT INFORMATION:
<b>S-17960</b>	783966C93 4140-01-199-4589 1299008 756-360-C	Heavy Duty Defrost Fan	Diameter: 7 1/2" Height: 8 3/4"	2-Wire Metal Cage
<b>S-18708</b>	DF12V	Dash Defrost Fan	Diameter: 7 1/2" Height: 8 5/8"	Universal Swivel Base w/ 60° Motor Leads 2 Speed

## BLOWER MOTORS & WHEELS

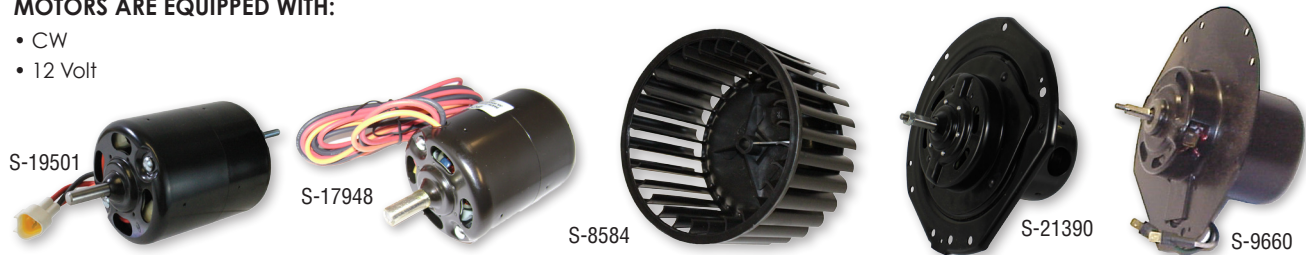
### MOTORS ARE EQUIPPED WITH:

- CW
- 12 Volt



NEWSTAR #:	REPLACES #:	DESCRIPTION:	APPLICATION:	DIMENSIONS:	PRODUCT INFORMATION:
<b>S-8584</b>	465502C1 1113002	Wheel	2000, 4000-5000 & 8000-9000 Series (1997-2002)	5" x 3" Bore Diameter: 5/16" Hub Insert: 1 1/2"	Plastic
<b>S-21390</b>	1669786C1 1099014	Motor	2000 Series Medium & Heavy Duty 3400 & 3600-3800 School Bus Series  4500-4900 Series Medium Duty 5000 Series Severe Duty 9600-9800 Premium Cabovers Models	4 3/4" x 4 1/8" x 3 1/8" Shaft: 5/16" x 1 1/16"	Flange Mounted Single Speed, Vented Permanent Magnet Motor Includes Wire Assembly Connector: Male Spade
<b>S-9660</b>	1699291C1	Motor	2000 Series (1998-2001) 4500-4900 Series Medium Duty (1996 & Before) 9609 & 9700 Series Premium Cabovers 9200-9700 Series Premium Conventionals (1995 & Before)	3 3/4" x 3 1/4" x 3 1/4" Shaft: 5/16" x 1"	Flange/Plate Mounted Single Speed, Vented Permanent Magnet Motor Connector: 2 Conductor Male Blade Packard
<b>S-17948</b>	2303279C1	Motor	Amtran & Thomas School Bus Models 	4 1/4" x 3 1/2" x 3" Shaft: 5/16" x 1" Span: 2 5/16"	Stud Mounted Single Shaft 2 Speed, Vented Field Wound Motor Connector: 3 Conductor Orange-High, Red-Low
<b>S-F429</b>	2503267C91	Motor	Multiple Applications	4 3/4" x 4" x 3" Shaft: 5/16" x 2 5/8" Span: 2 5/16"	Double Shaft, Vented Strap / Stud Mounted Connector: 1/4" Spade Receptacle PM Rotation
<b>S-19501</b>	2589563C1 2589648C1	Motor	Amtran, Thomas & IC Corp School Bus Models 	4 1/4" x 3 13/16" x 3" Shaft: 5/16" x 1"	Stud Mounted 2 Speed, Vented

All parts supplied are S&S Truck Parts Inc./NEWSTAR. Use of other manufacturer's names, part numbers, or trademarks are solely used for informational/identification purposes.

HVAC

## BLOWER MOTORS & WHEELS

### MOTORS ARE EQUIPPED WITH:

- CW
- 12 Volt



NEWSTAR #:	REPLACES #:	DESCRIPTION:	APPLICATION:	DIMENSIONS:	PRODUCT INFORMATION:
S-17942	2598644C1	Dual Motor Assembly Mount	Bluebird School Bus Models 	3 63/64" x 4 15/64" x 5"	3 Speed
S-17947	3542611C2	Motor Assembly Mount	Prostar Series (2008) 4200-4400, 7400-7600, 8500 & 8600 Series (2001-2007) 4000, 7000 & 8000 Series	4 1/32" x 1 25/32" x 3" Shaft Diameter: 5/16"	1 Speed, Vented
S-21198	3674285C1	Motor Assembly	4200-4400, 7400-7600 & 8500-8600 Series (2008-2011) 4100-4400 Series Medium Duty 7300-7700 Series Severe Duty Prostar Series (2009-2011) Prostar Linehaul Conventionals Lonestar Series (2009-2011)	6 13/32" x 3" x 1/4"	—

## COMPLEMENTARY COMPONENTS

**WHEEL W/ CLIP**  
S-17238



**MOTOR**  
S-17329

NEWSTAR #:	REPLACES #:	DESCRIPTION:	APPLICATION:	DIMENSIONS:	PRODUCT INFORMATION:
S-17238	1699947C1	Wheel	5000 & 9000 Series	5 3/4" x 3" Bore Diameter: 5/16" Hub Insert: 1 13/16"	CW Includes Clip
S-17239	1699949C1	Motor	5000I, 9100I, 9200I, 9400I & 9900I Series (2000-2010)	3 45/64" x 1" x 3 13/64" Shaft Diameter: 5/16"	Single Shaft-Flange Mounted CCW Single Speed, Vented

## BLOWER SWITCHES ON PAGE 93

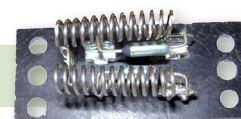

All parts supplied are S&S Truck Parts Inc./NEWSTAR. Use of other manufacturer's names, part numbers, or trademarks are solely used for informational/identification purposes.

## RECEIVER DRYERS



NEWSTAR #:	REPLACES #:	APPLICATION:	DESCRIPTION:	PRODUCT INFORMATION:
<b>S-13667</b>	1693117C1	1000, 4000, 5000, 8000 & 9000 Series 3400, 3600-3900 FC School Bus Series (1997 & Before) 	Diameter: 3" Length: 9 11/16"	Fitting: #6 O-Ring Male or Female High Capacity, Pressure Relief Switch Port: Top
<b>S-19500</b>	18-01800	4600-4900, 4954, 5000 & 8100-8300 Series (1991-2000)	Diameter: 3" Length: 8 1/2"	Fitting: #6 O-Ring Female In, Male Out Pressure Relief Switch Port : Top

## ACCUMULATORS



NEWSTAR #:	REPLACES #:	APPLICATION:	PRODUCT INFORMATION:
<b>S-22384</b>	3666273C1	4000 & 7000-9000 Series (2007-2010) 9000, 9000I, IX & Eagle Series (2008-2010)	Includes Pad Mount
<b>S-20544</b>	3670134C1	4100-4400 Series Medium Duty 7300-7700 Series Severe Duty 3200 Commercial School Bus Series  Prostar Linehaul Conventionals	Diameter: 3 5/32" Length: 7 25/32" Aluminum
<b>S-17246</b>	3542577C2 526333C2	7300 Series (Nov 2011 & Up) 4200-4400, 7300-7600 & 8500-8600 Series (2001-2007)	Inlet & Outlet: Pad Mount 1"-14 UNF Switch Port: M12 x 1.5 Bracket Mount: M8 x 1.25 Diameter: 3 1/2" Length: 9 1/8" Adjustable Studs, Includes Bracket Aluminum
<b>S-23316</b>	6102498C92	Prostar Series (2010-2013) 4200-4400, 7400-7600 & 8500-8600 Series (2010-2013) Terrastar 8600 Series Heavy Tractor	Height: 7 1/10"

All parts supplied are S&S Truck Parts Inc./NEWSTAR. Use of other manufacturer's names, part numbers, or trademarks are solely used for informational/identification purposes.

## CONDENSORS



S-17961

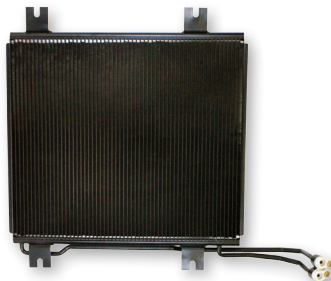

S-17244



S-17958

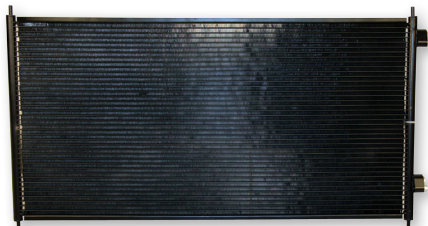

S-21563



S-22386

NEWSTAR #:	REPLACES #:	APPLICATION:	CORE DIMENSIONS:	PRODUCT INFORMATION:
<b>S-17961</b>	2507482C92	4000, 7000, 7100, 7300-7700, 8000-8600i & 9000-9900i Series (2001-2007)	21 <sup>53</sup> / <sub>64</sub> " x 19 <sup>37</sup> / <sub>64</sub> " x <sup>53</sup> / <sub>64</sub> "	Pad Mounted
<b>S-17244</b>	2508698C1	4000, 8000-8600i & 9000-9900i Series (2001-2007)	19 <sup>3</sup> / <sub>4</sub> " x 1" x 23 <sup>1</sup> / <sub>8</sub> "	—
<b>S-17958</b>	2586812C91	4000, 8000, 8100, 8200, 8300, 8500, 8600 & 8600i Series (2001-2007)	21 <sup>23</sup> / <sub>64</sub> " x 24 <sup>25</sup> / <sub>64</sub> " x <sup>5</sup> / <sub>8</sub> "	Pad Mounted
<b>S-21563</b>	2591621C93	9200, 9400 & 9900 Series Premium Conventionals (2001-2007) Prostar Linehaul Conventionals (2001-2007)	16mm x 825mm x 426mm	—
<b>S-22386</b>	2591836C91	Prostar Linehaul Conventionals (2007-2010)	30 <sup>1</sup> / <sub>2</sub> " x 16 x <sup>3</sup> / <sub>4</sub> "	—
<b>S-23110</b>	2000655C2	4600-4900 Series 7.3L Engine Models	26" x 25 <sup>3</sup> / <sub>4</sub> " x 1"	Inlet: #8 O-Ring MIO ( <sup>3</sup> / <sub>4</sub> "- 16) Male Outlet: #6 O-Ring MIO ( <sup>5</sup> / <sub>8</sub> "- 18) Male
<b>S-23022</b>	2585373C2	5000, 5000i, 5360, 5500, 5500i, 5600i, 5870 & 5900i Series (2000-2008) Cummins ISL, ISM, ISX, CAT C-12, C-13, C-15 & 3406 Engine Models Detroit 60 Engine Models	20 <sup>3</sup> / <sub>8</sub> " x 24 <sup>1</sup> / <sub>4</sub> " x <sup>7</sup> / <sub>8</sub> "	—
<b>S-23021</b>	2009378C2	9300, 9400 & 9800 Series Premium Conventionals	27" x 26" x <sup>3</sup> / <sub>4</sub> "	Inlet : #8 O-Ring MIO ( <sup>3</sup> / <sub>4</sub> "-16) Outlet: #6 O-Ring MIO ( <sup>5</sup> / <sub>8</sub> "-18)

All parts supplied are S&S Truck Parts Inc./NEWSTAR. Use of other manufacturer's names, part numbers, or trademarks are solely used for informational/identification purposes.

**FILTERS**

HVAC

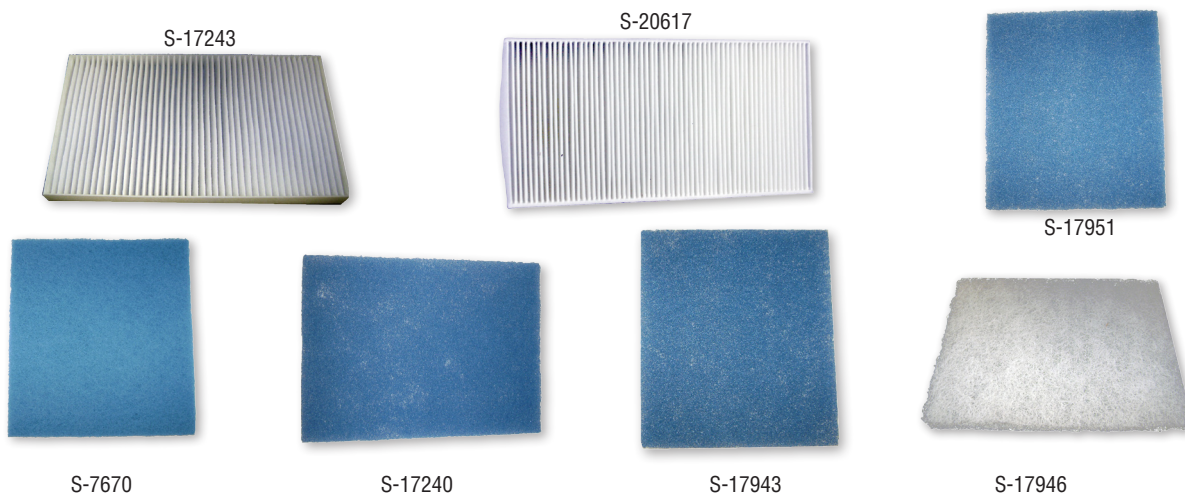

NEWSTAR #:	REPLACES #:	APPLICATION:	DIMENSIONS:
S-17951	481813C1	4500-4900 Series Medium Duty (1996 & Before)	12 1/2" x 13 1/2" x 1"
S-17240	1699956C2	500I-5900I Series Severe Duty (1995-2010) Pad Mounted	13 21/32" x 10" x 1/2"
S-17243	2506656C2 3548705C1	4100-4400 Series Medium Duty 7300-7700 Series Severe Duty Lonestar & Prostar Linehaul Conventionals	12 1/2" x 7 1/4" x 1"
S-20617	3839141C1	4200-4400 Series Medium Duty 7000 Series Severe Duty Prostar Linehaul Conventionals	12 3/8" x 6 1/4" x 1 1/8"
S-7670	498144C1	9100-9400 Series Premium Conventionals 9600-9800 Series Premium Cabovers	12 1/2" x 13 1/2" x 1"
S-17943	ZGG720010 530631 3112001	Pad Mounted	7 1/2" x 8 1/2" x 1/2"
S-17946	ZGG720014 3112009 526407	—	8" x 6 1/4" x 3/4"

All parts supplied are S&S Truck Parts Inc./NEWSTAR. Use of other manufacturer's names, part numbers, or trademarks are solely used for informational/identification purposes.



## YORK COMPRESSORS

### COMPRESSORS ARE EQUIPPED WITH:

- Tube O-Ring
- LH Suction
- 12 Volt
- R134A Refrigerant
- Fitting Size: 1"-14

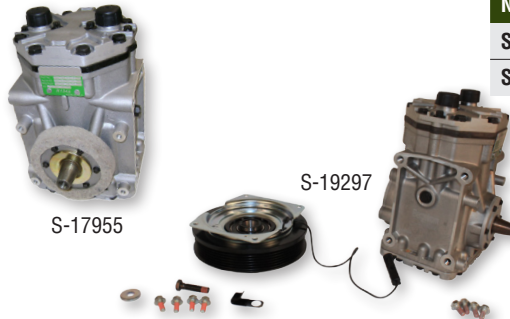

NEWSTAR #:	REPLACES #:	CLUTCH:	WIRE:
S-17955	2502459C91	No Clutch	—
S-19297	2509451C91	5 3/4", Poly 6, .014"	1

## SANDEN COMPRESSORS

### COMPRESSORS ARE EQUIPPED WITH:

- 12 Volt
- R134A Refrigerant





NEWSTAR #:	REPLACES #:	SANDEN #:	MODEL:	HEAD:	MOUNT:	CLUTCH:	WIRE:	APPLICATION:
S-19047	3628699C1 LE1600	4815	7H15HD	GWA	SD7 Direct Long	5 1/8" (130mm) Poly 6	1	Multiple Applications
S-17247	3582435C1	4418	7H15HD	441	SD7 Direct Long	4.7" (119mm) Poly 8	2	V8 Engine Models
S-19050	SKI 4493 ZGG705256 20501067	4493 4733 4892	7H15HD	WV	Direct	5 1/8" (130mm) Poly 8	2	Multiple Applications
S-19049	3547917C1 ABPN83-304314	4417 4485	7H15	GH	Direct	4.7" (119mm) Poly 8	—	Multiple Applications

## CLUTCH



NEWSTAR #:	REPLACES #:	DESCRIPTION:	PRODUCT INFORMATION:
S-19248	3527631C91	Clutch	9100, 9200, 9400 & 9900 Series Premium Conventionals 12 Volt, 6 Groove, 1 Wire Pulley Diameter : 6 1/8" Groove Width : 0.14 Single Wire w/ Diode/Female Weatherpak plug

## SEALS

NEWSTAR #:	REPLACES #:	DESCRIPTION:	PRODUCT INFORMATION:
S-20957	3543881C1	Sealing Ring	Tecumseh Compressor Head, Small Flange 9200, 9400 & 9900 Premium Conventionals 5500I-5900I Series Severe Service Prostar Linehaul Conventionals BE200 School Bus Series  C-Plate 1/2", 5/8" ID Discharge
S-20956	3543882C1		Tecumseh Compressor Head, Large Flange 9200, 9400 & 9900 Premium Conventionals 5500I-5900I Series Severe Duty Prostar Linehaul Conventionals BE200 School Bus Series  C-Plate 3/4", 13/16" ID Discharge



## ACTUATORS

NEWSTAR #:	REPLACES #:	PRODUCT INFORMATION:
S-17950	1664769C92	Piston Type w/ Gear Drive
S-17941	3542606C1	Piston Type 4000-4900, 5000, 5900i, 6300, 7000-7700, 8000 Series Moto Mode Control - 2 Terminal
S-17945	2503207C1	Piano Type 12 Volt, 4 Pin 120°, LH Drive
S-20950	3542575C2	Piano Type 4000-4900, 7000-7700, 8000-8600i Series (2001-2007) Prostar Linehaul Conventionals (2001-2007) 12 Volt, 2 Pin

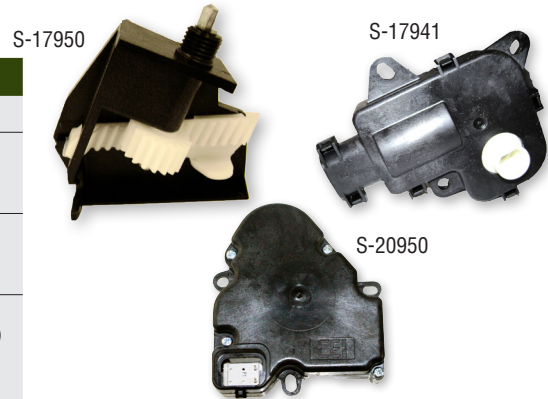

## EXPANSION VALVES

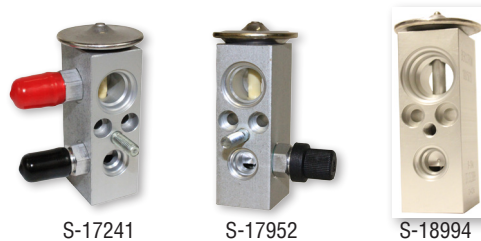

NEWSTAR #:	REPLACES #:	APPLICATION:	HOSE INLET/OUTLET:	PRODUCT INFORMATION:
S-18824	RD-5-6868-OP	—	Hose Inlet & Outlet: #6 (3/8") & #10 (5/8") Female O-Ring Evaporator Inlet & Outlet: #8 (1/2") Female O-Ring	Superheat Rating: 5°F Pressure Limit: 80 PSIG at 40°F
S-17241	2051794C93	5000I, 9100I, 9200I, 9400I, 9900I Series (2000-2010) 9000-9900I Series (1997-2006)	Hose Inlet & Outlet: #6 (3/8") & #10 (5/8") Flange Mount Evaporator Inlet & Outlet: #8 (1/2") Flange Mount	M10 & M12 Schrader Ports
S-17952	2503783C91	9200-9400 & 9600-9800 Series (2000-2002) S Series (1995-2001)	Hose Inlet & Outlet: #6 (3/8") & #10 (5/8") Female O-Ring Evaporator Inlet & Outlet: #8 (1/2") Female O-Ring	Schrader Ports Superheat Rating: 8°F Pressure Limit: 53.5 PSIG at 75°F
S-18994	3660853C2	4000, 7000, 8000 ProStar & LoneStar Series (2007-2010)	Hose Inlet & Outlet: #6 (3/8") & #12 (5/8") Female O-Ring Evaporator Inlet & Outlet: #8 (1/2") & #10 (5/8") Stat-O-Seal	2 Ton Models Superheat Rating: 5°F Pressure Limit: 80 PSIG at 53.5°F

All parts supplied are S&S Truck Parts Inc./NEWSTAR. Use of other manufacturer's names, part numbers, or trademarks are solely used for informational/identification purposes.

HVAC

## EVAPORATORS & HEATER CORES

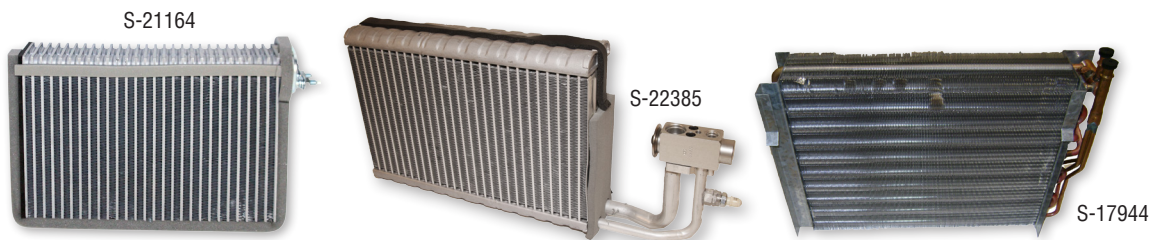

NEWSTAR #:	REPLACES #:	DESCRIPTION:	PRODUCT INFORMATION:
<b>S-21164</b>	3542576C2 2602544C1 1613008	Evaporator Assembly	4100-4300 Series Medium Duty (2001-2007) 7300-7700 Series Severe Duty (2001-2007) Prostar Linehaul Conventionals (2001-2007)
<b>S-22385</b>	1699950C1 1613011 151346		4100-4400 Series Medium Duty Prostar Linehaul Conventionals Core Dimensions: 6 <sup>5</sup> / <sub>8</sub> " x 2 <sup>5</sup> / <sub>8</sub> " x 12 <sup>1</sup> / <sub>16</sub> "
<b>S-17944</b>	3670132C1 1613007		5000-5900i, 9000-9900i (2000-2012) Core Dimensions: 10" x 2 <sup>5</sup> / <sub>8</sub> " x 13"

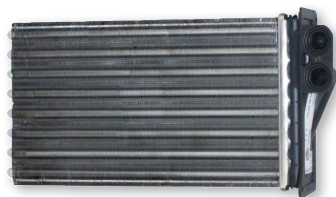

S-20949

NEWSTAR #:	REPLACES #:	DESCRIPTION:	PRODUCT INFORMATION:
<b>S-20949</b>	3599598C1 1713012	Heater Core	Prostar Linehaul Conventionals (2007-2010) 10 <sup>3</sup> / <sub>8</sub> " x 6" x 1 <sup>5</sup> / <sub>8</sub> "

## VALVES



S-17248

NEWSTAR #:	REPLACES #:	DESCRIPTION:	PRODUCT INFORMATION:
<b>S-17248</b>	367972C92	Manual Heater Shutoff Valve	9000, 9900i, IX & Eagle Series (1997-2000) <sup>3</sup> / <sub>4</sub> " Hose x <sup>1</sup> / <sub>2</sub> " NPT Male Thread



S-17954

NEWSTAR #:	REPLACES #:	DESCRIPTION:	PRODUCT INFORMATION:
<b>S-17954</b>	369512C92	Heater Valve	4000 & 5000 Series Severe Duty Ports: <sup>5</sup> / <sub>8</sub> " Hose <sup>1</sup> / <sub>2</sub> "-14" NPT Male Thread Thread Manually Operated



S-4889

NEWSTAR #:	REPLACES #:	DESCRIPTION:	PRODUCT INFORMATION:
<b>S-4889</b>	450907C1	Water Valve	S-Series Ports: <sup>5</sup> / <sub>8</sub> " Barb 90° Angle, <sup>1</sup> / <sub>2</sub> " x 14" NPT Female Thread Knob Operated

All parts supplied are S&S Truck Parts Inc./NEWSTAR. Use of other manufacturer's names, part numbers, or trademarks are solely used for informational/identification purposes.

## BOOSTER PUMPS



NEWSTAR #:	REPLACES #:	PRODUCT INFORMATION:
<b>S-17962</b>	2227279C2 1099073 ZGG701076	3000, CE, FE & RE School Bus Series  90° Inlet 12 Volt

## DASH COMPONENTS

NEWSTAR #:	REPLACES #:	DESCRIPTION:	PRODUCT INFORMATION:
<b>S-17936</b>	3529263C1 748040 3213003	Louver Assembly	Multiple Applications



S-17936

## ORIFICE TUBES

NEWSTAR #:	REPLACES #:	PRODUCT INFORMATION:
<b>S-17939</b>	3548044C1 1813008	Multiple Applications Purple



S-17939

## REGULATOR CONTROLS

NEWSTAR #:	REPLACES #:	PRODUCT INFORMATION:
<b>S-17959</b>	3562102C1 651186 2013005	4000, 4600, 4700, 4900, 5000, 7100, 7400, 8000, 9000-9900 (2002-2007)



S-17959

## SENSORS



NEWSTAR #:	REPLACES #:	DESCRIPTION:	PRODUCT INFORMATION:
<b>S-20524</b>	3622764C3 BOA 80-908-00-329	Freon Sensor	4200-4400, 7400-7600, 8500 & 8600 Series Prostar Linehaul Conventionals (Thermister) Fitting Connector: M12 Thread

NEWSTAR #:	REPLACES #:	DESCRIPTION:	PRODUCT INFORMATION:
<b>S-23708</b>	2606229C91	Freon Sensor Kit	4200-4400, 7400-7600, 8500 & 8600 Series Prostar Linehaul Conventionals (Thermister) Fitting Connector: M12 Thread

All parts supplied are S&S Truck Parts Inc./NEWSTAR. Use of other manufacturer's names, part numbers, or trademarks are solely used for informational/identification purposes.

## FREON TUBES

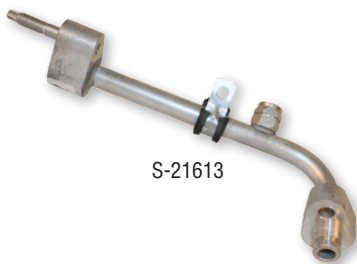

S-21613

NEWSTAR #:	REPLACES #:	DESCRIPTION:	PRODUCT INFORMATION:
<b>S-21613</b>	3542578C2	Freon Tube	4100, 4200 & 4300 Medium Duty Series 7300-7700 Severe Duty Series Prostar Linehaul Conventional Models

## SWITCHES

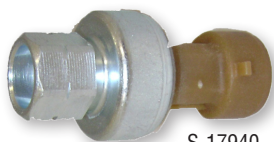

S-17940

NEWSTAR #:	REPLACES #:	DESCRIPTION:	PRODUCT INFORMATION:
<b>S-17940</b>	3546241C1	Pressure Switch	4000-4900, 5000-5900i & 8000-8600i Series (2006-2010) Fitting Connector: M10 Thread, 3 Pin



S-17957

NEWSTAR #:	REPLACES #:	DESCRIPTION:	PRODUCT INFORMATION:
<b>S-17957</b>	581691C1	Cable Controlled Thermostat Switch	5000, 7100 & 9000-9700 Series (1973-2001) Capillary Length: 43" Variable Temperature Type Range: 30°-62°F Clutch Cycle Range: 10°F Mounting Hole Spacing: 2 15/16"



## POWER STEERING PUMPS

REPLACEMENT FOR LUK

NEWSTAR #	REPLACES #:	PRODUCT INFORMATION:
S-17041	1682625C91	Detroit 60 & CAT 3406 Engines 2 Line Pump, 2 Bolt Flange, 11 Tooth Spline Shaft 4.00 USGPM Flow Rate at 1200 RPM 2175 PSI, CCW
S-17552	2005337C91 3525624C91 3514596C91	Replaces Cummins, I-6 Engine Models, B,C, CAT 3116 2 Line Pump, 2 Bolt Flange, 11 Tooth Spline Shaft 4.00 USGPM Flow Rate at 1200 RPM 2175 PSI, CW
S-5890	1681047C91	Popular Cummins C10/C12/NTC/N14 Engines 2 Line Pump w/ Aluminum Construction, 2 Bolt Flange, 11 Tooth Spline Shaft 3.75 USGPM Flow Rate 1740 PSI, CW
S-D484	1663204C91 3504849C91 3504850C91 1667497C91 1682626C91 1686653C91	Popular Cummins C10/C12/NTC/N14 Engines w/ TAS65 & M100 Steering Gears 2 Line Pump w/ Aluminum Construction, 2 Bolt Flange, 11 Tooth Spline Shaft 4 USGPM Flow Rate 2175 PSI, CW

S-D484



S-17041

S-5890



S-17552

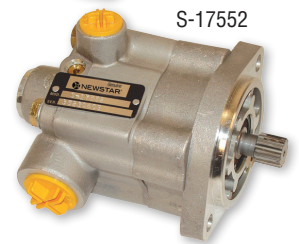

## POWER STEERING PUMPS

REPLACEMENT FOR HOBOURN MODEL BB

NEWSTAR #	REPLACES #:	PRODUCT INFORMATION:
S-B215	1647567C91 1677288C91 1675898C91 1651836C91 1644377C91 1665552C91 596246C92	Re-Install Reservoir, Tubes & Hardware Pulley Driven Bolt & Key Shaft 11 Tooth Spline Shaft 5.5-6 USGPM Flow Rate 2300 PSI, CW
S-B216	1614025C91 1655606C91 1665551C91 1684290C91 1671876C91 1654717C91 1655607C91 1664376C91 1666272C91 1671589C91	6.9-7.3L Diesel Applications Re-Install Reservoir, Tubes & Hardware Bolt & Key Shaft 11 Tooth Spline Shaft 5.5-6 USGPM Flow Rate 2350 PSI, CCW

S-B215

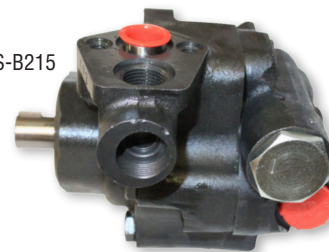

S-B216

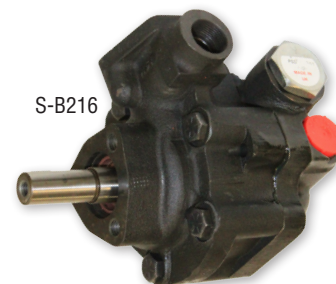

## POWER STEERING PUMPS

REPLACEMENT FOR SAGINAW



NEWSTAR #	REPLACES #:	PRODUCT INFORMATION:
S-5897	488787C91	New Pump w/ Reservoir

## POWER STEERING PUMPS

REPLACEMENT FOR VICKERS V-20NF ARE EQUIPPED WITH:

- 2 Line Pump & Flow Control Cover
- 2 Bolt Flange- SAE "A" Size
- 1 5/16" -12 Inlet Port, 3/4" NPT Pressure Outlet Port
- Feature Long Life Cast Iron Construction
- Interchangeable w/ Vickers Pumps
- Capacity: GPM at 1200 RPM-100 PSI

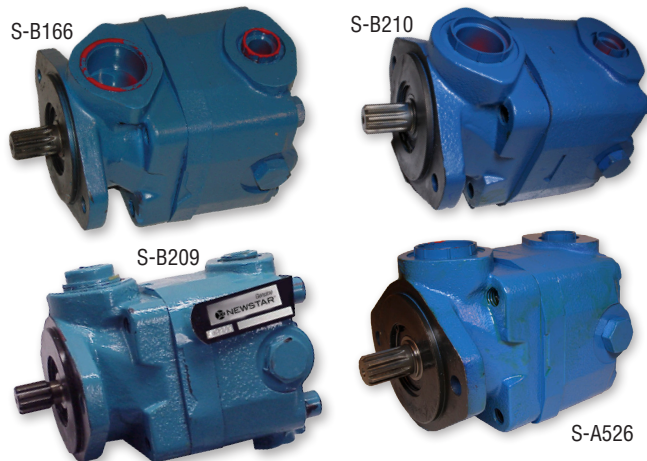

NEWSTAR #	REPLACES #:	PRODUCT INFORMATION:
S-B166	583808C91	11 Capacity, 11 Tooth Spline Shaft 7 USGPM Flow Rate 2000 PSI, CW
S-A526	541508C91 1516829C91	6 Capacity, 11 Tooth Spline Shaft 6 USGPM Flow Rate 1750 PSI, CW
S-B209	585930C91	9 Capacity, 11 Tooth Spline Shaft 6 USGPM Flow Rate 1750 PSI, CW
S-B210	541510C91 1618607C91	9 Capacity, 11 Tooth Spline Shaft 6 USGPM Flow Rate 1750 PSI, CCW

## POWER STEERING PUMPS

REPLACEMENT FOR VICKERS V-10NF ARE EQUIPPED WITH:

- 2 Line Pump & Flow Control Cover
- 2 Bolt Flange- SAE "A" Size
- 1 5/16" -12 Inlet Port, 3/4"-16 NPT Pressure Outlet Port
- Feature Long Life Cast Iron Construction
- Interchangeable w/ Vickers Pumps
- Capacity: GPM at 1200 RPM-100 PSI



NEWSTAR #	REPLACES #:	PRODUCT INFORMATION:
S-B163	1654771C91	5 Capacity, 11 Tooth Spline Shaft 4 USGPM Flow Rate 2175 PSI, CW
S-B164	595055C91 1681049C91	5 Capacity, 11 Tooth Spline Shaft 5 USGPM Flow Rate 2000 PSI, CW
S-A711	582135C92 1681048C91	5 Capacity, 11 Tooth Spline Shaft 5 USGPM Flow Rate 1750 PSI, CW

All parts supplied are S&S Truck Parts Inc./NEWSTAR. Use of other manufacturer's names, part numbers, or trademarks are solely used for informational/identification purposes.

## POWER STEERING PUMPS

### REPLACEMENT FOR VICKERS V-20F ARE EQUIPPED WITH:

- 3 Line Pump & Flow Control Cover
- 2 Bolt Flange- SAE "A" Size
- 1 1/4" NPT Inlet Port, 1/2" NPT Tank Port & 3/4" - 16 Pressure Port
- Feature Long Life Cast Iron Construction
- Interchangeable w/ Vickers Pumps



NEWSTAR #	REPLACES #:	PRODUCT INFORMATION:
S-A525	422479C91	9 GPM AT 1200 RPM, 100 PSI Capacity, 11 Tooth Spline Shaft 6 USGPM Flow Rate 1750 PSI, CW

## REBUILDING COMPONENTS

### REPLACEMENT FOR HOUBORN B-SERIES

NEWSTAR #	REPLACES #:	DESCRIPTION:
S-4912	467537C91	Reservoir Cap Assembly
S-7979	505657C92	Mounting Kit
S-4376	507809C91	Reservoir Filter Kit
S-4957	507810C91	O-Ring Kit

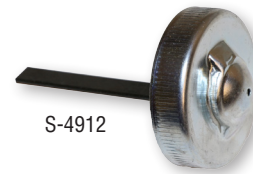

## REBUILDING COMPONENTS

### REPLACEMENT FOR SAGINAW

NEWSTAR #:	REPLACES #:	DESCRIPTION:	APPLICATION:
S-7995	482350C91	Sector Shaft Seal	Rotary Valve
S-7997	493133C91	Bearing 2.003 O.D.	Dual Piston 710 Models
S-4336	493141C91	Master Ring & Seal Kit	Dual Piston 710 Models
S-4950	493143C91	Pitman Shaft Kit	Dual Piston 710 Models



## REBUILDING COMPONENTS

### REPLACEMENT FOR VICKERS

NEWSTAR #:	REPLACES #:	APPLICATION
S-7988	434031C91	Pump Series V10
S-7989	590727C91	Pump Series V20

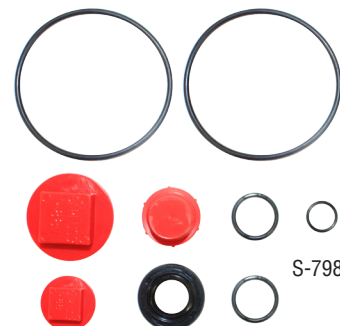

All parts supplied are S&S Truck Parts Inc./NEWSTAR. Use of other manufacturer's names, part numbers, or trademarks are solely used for informational/identification purposes.

## REBUILDING KITS

REPLACEMENT FOR SAGINAW 143 MODELS

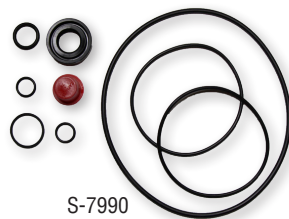

NEWSTAR #	REPLACES #:	DESCRIPTION:
S-7990	594210C91	Master Kit

## REBUILDING KITS & COMPONENTS

REPLACEMENT FOR TRW

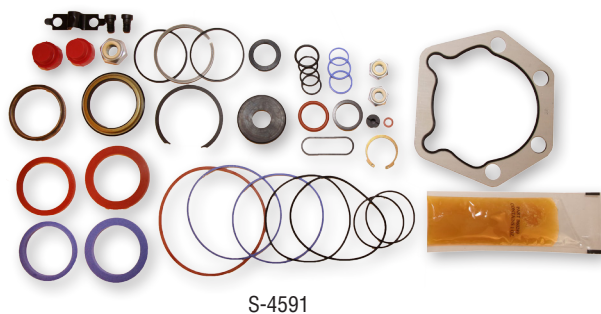

NEWSTAR #	REPLACES #:	DESCRIPTION:	APPLICATION:
S-4591	583823C91	Master Kit	HFB 52
S-8022	487340C1	Housing Outer Seal	HFB 52
S-4033	472925C91	Master Kit	HF 54
S-8000	435673C1	Pinion Ring	HF 54
S-4590	582463C91	Master Kit	HFB 64
S-8021	487339C91	Housing Seal	HFB 64
S-4935	487344C91	Sector Shaft	HFB 64 & TAS 65
S-4412	472933C91	Master Kit	HF 64
S-7943	435854C91	Sector Shaft	HF 64
S-8933	487320C91	Thrust Bearing	HF 64 & HFB 64
S-7198	1692999C91	Master Kit	HF 70
S-B066	2502017C91	Input Shaft Seal Kit	TAS
S-9501	2505258C91	Rebuild Kit w/o Hardware	TAS 40
S-9502	1675138C91	Rebuild Kit w/o Hardware	TAS 55
S-D654	1668438C91	Sector Shaft Bearing	TAS 65
S-7627	1671216C93	Master Kit	TAS 65
S-9504	2508032C91	Master Kit	TAS 85

All parts supplied are S&S Truck Parts Inc./NEWSTAR. Use of other manufacturer's names, part numbers, or trademarks are solely used for informational/identification purposes.

## REBUILDING KITS & COMPONENTS

### REPLACEMENT FOR SHEPPARD



S-11557



S-11556

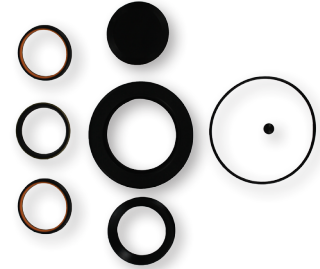

S-19203

NEWSTAR #:	REPLACES #:	DESCRIPTION:	APPLICATION:
S-19204	2589611C91	Steering Gear Kit	Sheppard M80
S-D694	1685190C91	Input Seals & Shaft Valve Ring Kit	Sheppard M80, 90, 100
S-11558	1691583C91 2585855C91 2586316C91	Master Kit	Sheppard M80
S-11556	2585853C91 1685676C91	Input Seal Kit	Sheppard M80, 90, 100, 110
S-D421	2502009C92 2592441C91	Steering Gear Kit	Sheppard M90
S-11557	1696908C91	Sector Seal Kit	Sheppard M90 & M100
S-E445	1668428C91	Sector Shaft	Sheppard M90
S-19204	2589611C91	Sector Shaft Seal Kit (Late Design)	Sheppard M90 & M100
S-16201	2502008C91 2592442C91	Steering Gear Kit	Sheppard M100
S-E036	1663631C1 2590468C1	Sector Shaft	Sheppard M100
S-17692	2585860C91 1663632C91	Sector Shaft Cover Kit	Sheppard M100
S-19203	2585854C91 2592443C91	Sector Shaft Seal Kit	Sheppard M100
S-18828	2592444C91	Master Kit w/ Snap Ring & L Seal	Sheppard M110
S-18827	2586319C91	Master Kit	Sheppard M110
S-19311	2585858C91	End Cap Seal Kit	Sheppard M110
S-21202	2591854C91	Master Kit	Sheppard HD94
S-5370	406280C1	Bronze Bushing	Sheppard Series 3, 4 & 5 2" ID x 2 3/8" OD Models 372 & 392
S-7942	438758C1	Bronze Bushing	Sheppard Series 3, 4 & 5 2" ID x 2 1/4" OD Models 292, 372 & 392
S-7983	1651917C91	Master Kit	Sheppard Series 6 Model 392
S-7982	1648256C91	Master Kit	Sheppard Series 3, 4 & 5; Model 292
S-7984	3243261C91	Master Kit	Sheppard Series 3, 4 & 5; Model 392
S-7985	1648322C91 1693937C91	Master Kit	Sheppard Series 3, 4 & 5; Model 492
S-7986	1691691C91	Master Kit	Sheppard Series 3, 4 & 5; Model 592
S-D837	1694395C91 1651779C91	Input Shaft Seal Kit	Sheppard 292, 392, 492 & 592

All parts supplied are S&S Truck Parts Inc./NEWSTAR. Use of other manufacturer's names, part numbers, or trademarks are solely used for informational/identification purposes.



## SECTOR SHAFTS

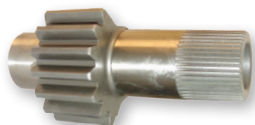

S-E036

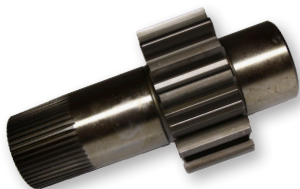

S-E445



S-7943

S-4935

NEWSTAR #	REPLACES #:	APPLICATION:
S-E036	1663631C1 2590468C1	Late Model S Series, M100 Applications
S-E445	1668428C1	Late Model S Series, M90 Applications
S-7943	435854C91	Late Model S Series, HF64 Applications
S-4935	487344C91	Late Model S Series, HFB64 & TAS65 Applications

## ADDITIONAL STEERING COMPONENTS



S-19406

NEWSTAR #	REPLACES #:	DESCRIPTION:	APPLICATION:
S-19406	1829802C1	High Pressure Pump Hose	Various Detroit Diesel & Perkins Engine Models 3000, FE, IC, RE School Bus Series (Nov. 1999 & Up)  3400-3900 School Bus Series 

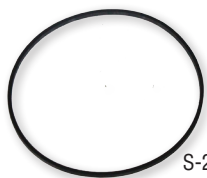



S-20704

NEWSTAR #	REPLACES #:	DESCRIPTION:	APPLICATION:
S-20704	2507061C1	Reservoir Gasket	4000 Series Medium Duty 5500, 5600, 5900I & 7000 Severe Service 9200, 9400 & 9900 Series Premium Conventionals

## ICP ENGINE SENSORS



S-23519

NEWSTAR #:	REPLACES #:	PRODUCT INFORMATION:
<b>S-23519</b>	1812818C2	International DT466E & I530E Engine Models International 3400, 3600, 3700 & 3800 School Bus Series International 4500, 4700, 4800 & 4900 Series Medium Duty
<b>S-20557</b>	1807329C92	3000 School Bus Series & 4700 Series Medium Duty  T444E Engine Models
<b>S-21205</b>	1830669C92	2500 & 2600 Heavy Duty Models 3000, RE, 3600 & 3700 School Bus Series  4700-4900 Series Medium Duty 5000, 5500I, 5600I & 7500 Series Severe Service Conventionals 8100 & 8500 Series Heavy Duty

## CIRCUIT BREAKERS



S-20306

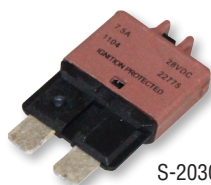





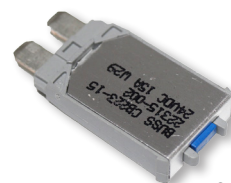

S-20305



S-20307



S-21838

NEWSTAR #:	REPLACES #:	DESCRIPTION:	PRODUCT INFORMATION:
<b>S-20305</b>	3529673C1	Resettable Circuit Breaker 7.5 Amp	3000, BE200, CE200/300, FE200 & RE300 School Bus Series 
<b>S-20306</b>	3529674C1	Resettable Circuit Breaker 10 Amp	3000, BE200, CE200/300, FE200 & RE300 School Bus Series 
<b>S-21838</b>	3529675C1	15 Amp Type 3-ATO Blue Blade	3000, BE200, CE200, 300, FE & RE300 School Bus Series  4700-4900 Series Medium Duty
<b>S-21839</b>	3529676C1	20 Amp Type 3-ATO Yellow Blade	3000, BE200, CE200, 300, FE & RE300 School Bus Series  4700-4900 Series Medium Duty
<b>S-21840</b>	3529677C1	25 Amp Type 3-ATO Clear Blade	3000, BE200, CE200, 300, FE & RE300 School Bus Series  4700-4900 Series Medium Duty
<b>S-20307</b>	3529678C1	Resettable Circuit Breaker 30 Amp	3000, BE200, CE200/300, FE200 & RE300 School Bus Series 

All parts supplied are S&S Truck Parts Inc./NEWSTAR. Use of other manufacturer's names, part numbers, or trademarks are solely used for informational/identification purposes.

## RELAYS



S-20023



S-9443

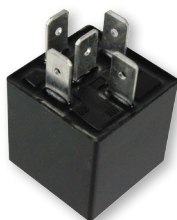

S-19847

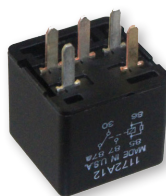







S-20975



S-17314











S-21994

NEWSTAR #:	REPLACES #:	DESCRIPTION:	PRODUCT INFORMATION:
S-5971	447186C1	Turn Signal Relay	S Series Medium & Heavy Duty Non-Canceling Switch
S-7606	505457C1	Horn Relay	9370 & 9670 Models
<b>S-20023</b>	1831646C1	Glow Plug Relay	4700 Series Medium Duty 3000, 3600 & 3800 School Bus Series  T444E Engine Models
<b>S-20710</b>	1840903C91	Glow Plug Relay	Ford VT365 Engine Models (2002-2005) 4.5L, 6.0 Diesel Injected Turbos BE200, CE200/300, RE300 School Bus Series 
S-9443	2012557C1 1672537C1	Horn Relay	4000, 7000 & 8000 Series
S-5115	241120R91	Horn Relay	1700-2600 Series Medium Duty (1989 & Before) 5000 Series
S-20975	2602142C1	Horn Relay	BE200, CE200 & RE200 School Bus Series 
S-17314	3505300C1	Relay	4100-4900 Series Medium Duty 3000 FE, IC & RE School Bus Series 3600 & 3800 School Bus Series (May 1997 & Up)  Amtran, BE200, CE200 & CE300 School Bus Series
S-21950	3519350C1	Micro Relay	4000 Series Medium Duty 7000 Series Severe Duty Prostar Linehaul Conventionals BE200, CE200, 300 & RE300 School Bus Series 
S-21994	3571998C1	Generator Relay	BE, CE, FE, RE200 & 300 School Bus Series 
S-19847	3607384C1 2012557C1	Horn Relay	1000, 4000, 7000 & 8000 Series BE200, CE200/300 School Bus Series 

## ADDITIONAL SENSORS



NEWSTAR #:	REPLACES #:	DESCRIPTION:	APPLICATION:
<b>S-20817</b>	1669290C91	Speed/Tachometer Sensor	3400, 3600, 3700 & 3900 School Bus Series (May 1997 & Before)  3800 School Bus Series (May 1997 & Up)  4000 Series Medium Duty (August 1998 & Up)
<b>S-21317</b>	1807369C2	Oil Pressure Sensor	4300, 4400, 4700, 4800 & 4900 Series Medium Duty 5000, 5500I, 5600I, 7300, 7400 & 7500 Series Severe Duty DT466E, I530E & HT530 Engine Models 3000, RE, 3600, 3800, Amtran, RE, CE200, 300 School Bus Series 
<b>S-21161</b>	1825899C93 1876735C91	Cam Position Sensor	7.3L Powerstroke
<b>S-20445</b>	1828345C91	Crankshaft Position Sensor	VT275 & 365 Engine Models
<b>S-20620</b>	1835985C92	Camshaft Sensor	VT365 Engine Models CE200 & CE300 School Bus Series 
<b>S-20814</b>	1840078C1	Manifold Pressure Sensor	Amtran & Genesis CE200 & CE300 Conventionals 4000 Series Medium Duty T444E & VT365 Engine Models 3000FE, RE & IC School Bus Series (May 1999 & Up)  3600 & 3800 School Bus Series (May 1997 & Up) 
<b>S-20815</b>	1850352C2	Exhaust Back Pressure Sensor	VT365 Engine Models (2005-2007) 3200, 3300, RE300, BE200, CE200 & CE300 School Bus Series 
<b>S-21364</b>	1850353C2	Pressure Sensor	4200 Series Medium Duty VT365 Engine Models
<b>S-19596</b>	1885812C91	Cam Positioning Sensor	34000 Series Medium Duty 5000 & 7000 Series Severe Duty DT466E & I530E Engine Models 000 FE, IC & RE School Bus Series  3600 & 3800 School Bus Series (May 1997 & Up)  CE200 & CE300 School Bus Series 
<b>S-20813</b>	1889995C91	Temperature Sensor	DT466E & I530E Engine Models 3000 FE, IC & RE School Bus Series  3600 & 3800 School Bus Series (May 1997 & Up) 
<b>S-22555</b>	1839416C91	Intake Manifold Sensor	4100-4400 Series Medium Duty BE200, CE200, 300, FE600 & RE300 School Bus Series 
<b>S-20290</b>	1845428C92	ICP Sensor	4100 & 4200 Series Medium Duty BE200, CE200, 300 & RE300 School Bus Series 
<b>S-22413</b>	1846481C92	Intake Manifold Sensor	Prostar Linehaul Conventionals 4100-4400 Series Medium Duty DT466E Engines Models BE200, CE200/300 School Bus Series 
<b>S-22764</b>	1875784C93	ICP Sensor	4300 & 4400 Series Medium Duty 7300-7500 Series Severe Duty Maxxforce Engine Models BE200, CE200, 300, FE600 & RE300 School Bus Series 

All parts supplied are S&S Truck Parts Inc./NEWSTAR. Use of other manufacturer's names, part numbers, or trademarks are solely used for informational/identification purposes.

## AIR BAGS



S-22471



S-22470

NEWSTAR #:	REPLACES #:	PRODUCT INFORMATION:
<b>S-22471</b>	1R12-432	7000 Severe Service Series Prostar Linehaul Conventionals 9000 Premium Conventional Series
<b>S-22470</b>	1R12-538	3000 Amtran School Bus Series 9000 Series Premium Conventionals
<b>S-22467</b>	1R14-039 1685174C1	Heavy Duty Applications

## BOLTS



S-13807





S-9022

NEWSTAR #:	REPLACES #:	DIMENSIONS:
<b>S-4433</b>	414051C1	1/2"-20 x 1 1/4"
<b>S-4434</b>	414052C1	1/2"-20 x 1 1/2"
<b>S-4435</b>	414053C1	1/2"-20 x 1 3/4"
<b>S-4436</b>	414054C1	1/2"-20 x 2"
<b>S-4437</b>	414055C1	1/2"-20 x 2 1/4"
<b>S-4438</b>	414056C1	1/2"-20 x 2 1/2"
<b>S-4505</b>	414076C1	5/8"-18 x 1 1/2"
<b>S-4733</b>	414077C1	5/8"-18 x 1 3/4"
<b>S-4734</b>	414078C1	5/8"-18 x 2"
<b>S-4735</b>	414079C1	5/8"-18 x 2 1/4"
<b>S-4736</b>	414080C1	5/8"-18 x 2 1/2"
<b>S-5861</b>	414081C1	5/8"-18 x 2 3/4"
<b>S-5862</b>	414082C1	5/8"-18 x 3"
<b>S-4442</b>	414084C1	5/8"-18 x 3 1/2"
<b>S-C635</b>	416734C1	3/4"-16 x 2"
<b>S-7604</b>	416736C1	3/4"-16 x 2 1/2"
<b>S-14718</b>	416739C1	3/4"-16 x 3 1/4"
<b>S-14109</b>	416740C1	3/4"-16 x 3 1/2"
<b>S-8420</b>	438286C1	5/8"-18 x 4 1/2"
<b>S-9022</b>	414086C1	5/8"-18 x 4"
<b>S-13807</b>	414085C1	5/8"-18 x 3 3/4"



## U-BOLT

NEWSTAR #:	REPLACES #:	PRODUCT INFORMATION:
S-3072	465916C1	4500-4900 Series Medium Duty 9200-9400 Series Conventionals 9600-9800 Series Cabovers 3400-3800 School Bus Series  Dimensions: 3/4" - 16 x 10" x 4" Semi-Round
S-19488	465919C1	44000 Series 3400-3900 School Bus Series  Dimensions: 5/8" - 18 x 8" x 3-1/32"
S-A414	1514626C1	4500-4900 Series Medium Duty 9200-9400 Series Conventionals 9600-9800 Series Cabovers 3000-3900 & Amtran School Bus Series 



S-3072

S-19488

## DRAG LINKS

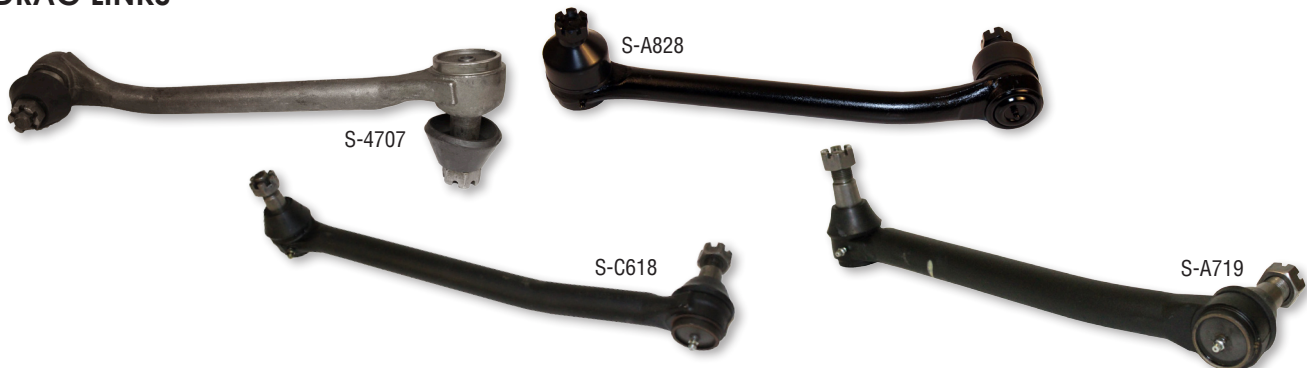

S-4707

S-A828

S-C618

S-A719

NEWSTAR #:	REPLACES #:	PRODUCT INFORMATION:
S-23612	ETN0815326 2515-723-C	Tube Length 60" Tube Diameter 1.66" Consists Of One Each 817018 & 817019 Tie Rod Ends
S-23613	971443	Eaton E1200W Front Axles
S-4707	FDL970A FDL970 400745C	CargoStar Series Length: 14 <sup>3</sup> / <sub>4</sub> " FA98 & 101 Front Axles
S-A828	FDL979A FDL979	8000 Series (1998 & Before) Length: 18 <sup>9</sup> / <sub>64</sub> "
S-A719	FDL1214A 1661437C92	Series & 8000 Series COF5870 Length: 17 <sup>43</sup> / <sub>64</sub> "
S-C618	FDL1215A FDL1215 661867C91	I60S & I80S Front Axles Length: 17 <sup>15</sup> / <sub>32</sub> "



S-23612

S-23613

All parts supplied are S&S Truck Parts Inc./NEWSTAR. Use of other manufacturer's names, part numbers, or trademarks are solely used for informational/identification purposes.

## KING PIN KITS



S-17327

NEWSTAR #:	OEM #:	DIMENSIONS:	REPLACEMENT FOR TRW #:	REPLACEMENT FOR MERITOR #:	APPLICATIONS:
<b>S-4949</b>	493095C91 FAK 4500 FAK 5447 FAK 5448 337KK100	1 39/64" x 9 5/32"	K554B	R200057 Bronze	FA309 Single Drawkey Axle Models
<b>S-5134</b>	586806C91 FAK 4516 FAK 5451 309KK102	1 39/64" x 9 5/32"	K571B	R200073 Bronze	FA309 Double Drawkey Axle Models
<b>S-7801</b>	588808C91 FAK 4517 343KK105	1 39/64" x 9 21/32"	K535B (K572B)	R200074 Bronze	FA118, 127, 139, 309, 329, 339, 342 & 401 Double Drawkey Axle Models
<b>S-6942</b>	FAK 4538	1 39/64" x 8 3/4"	K526D	R200156 Nylon (ROR 156)	Meritor FE-970 Axle Models
<b>S-6943</b>	FAK 4550 FAK 4539 303138C92	1 39/64" x 8 3/4"	K526B	R200157 Bronze (ROR 157)	Meritor FE-970 Axle Models
<b>S-6944</b>	FAK 4540	14 51/64" x 9 1/8"	K504	R200167 Nylon (ROR 167)	Meritor FD-211, 215, 216 & 218 Axle Models
<b>S-6945</b>	FAK 4541	1 63/64" x 11 3/64"	K542D	R200168 Nylon (ROR 168)	Meritor FL-901 & FH-901 Axle Models
<b>S-6946</b>	FAK 4571 FAK 4542 301-SQ-44 303140C92	1 63/64" x 11 3/64"	K541B	R200170 Bronze (ROR 170)	Meritor FL-901 & FH-901 Axle Models
<b>S-6947</b>	FAK 4551 FAK 4544 303139C91	1 51/64" x 9 1/8"	K510B	R200172 Bronze (ROR 172)	Meritor FA-211, 215, 216 & 218 Axle Models
<b>S-6950</b>	FAK 4559 FAK 4553 452344C91	1 51/64" x 10 13/32"	K534B	R200199 Bronze (ROR 199) R200193	Meritor FF-921 Axle Models
<b>S-6949</b>	FAK 4558 474520C91 597258C91	1 63/64" x 11 7/32"	K547B	R200198 Bronze (ROR 198)	Meritor FL-931 Axle Models
<b>S-6963</b>	FAK 4560	1 39/64" x 9 3/8"	K570B	R201300 Bronze (ROR 1300)	Meritor FF-971 Axle Models
<b>S-6964</b>	FAK 4564	1 51/64" x 10 25/64"	K576C	R201307 E-Z Steer (ROR 1307)	Meritor FF931, 932-934 & 941-944 Axle Models

All parts supplied are S&S Truck Parts Inc./NEWSTAR. Use of other manufacturer's names, part numbers, or trademarks are solely used for informational/identification purposes.

**KING PIN KITS**



S-A482

NEWSTAR #:	OEM #:	DIMENSIONS:	REPLACEMENT FOR TRW #:	REPLACEMENT FOR MERITOR #:	APPLICATION:
S-6965	FAK 4566	1 51/64" x 10 25/64"	K583	R201309 E-Z Steer (ROR 1309)	Meritor FF941, 952, FG931, 933, 943, 952, 17100, 17101 Axle Models
S-8513	FAK 4567	1 51/64" x 10 25/64"	—	R201310 Bronze (ROR 1310)	Meritor FG931 Axle Models
S-8529	FAK 4568 597258C91	1 63/64" x 11 7/32"	K585	R201312 E-Z Steer (ROR 1312)	Meritor FL931, 941, 943, 951 Axle Models
S-8678	FAK4570 TDAR201315	1 51/64" x 10 25/64"	K582	R201315 E-Z Steer (ROR 1315)	Meritor FO & FF961 Axle Models
S-6485	806355 FAK 4572 1008431 ETN806355	1 5/8" x 9 13/64"	K584	R200267 E-Z Steer	Dana/Eaton EFA12F4 Axle Models
S-6486	806356 FAK 4573	1 5/8" x 9 13/64"	K586	R200251 E-Z Steer	Dana/Eaton EFA12F3 & 13F3 Axle Models
S-9304	FAK 4582 1660271C91 1660271C92	1 23/64" x 7 31/32"	K592	R200268 Bronze	I60 & 80 Double Drawkey Axle Models
S-8371	806355B FAK 4583	1 5/8" x 9 13/64"	K609	R200269 Bronze	Dana/Eaton EFA12F4 Axle Models
S-A811	FAK 4601	1 59/64" x 9 7/8"	K602	R201426 Bronze	I100S & I120S Axle Models
S-D562	823078B FAK 4610 ETN038342	1 51/64" x 9 3/64"	—	R200281 Bronze	Dana/Eaton E1000I & 1200I Axle Models
S-5223	473695C91 1648204C91 FAK 5444 FAK 5452 101KK109 101KK110 FAK4519	1 23/64" x 7 31/32"	K549B	R200052 Bronze	FA71, 73, 74, 101, 103 & 104 Single Drawkey Axle Models
S-4988	1658934C91 FAK 5453 343KK103	1 39/64" x 9 21/32"	K594	R200278 E-Z Steer	FA118, 127, 139, 309, 339, 342 & 401 Double Drawkey Axle Models
S-A483	FAK 5455 1668411C92 120KK100	1 59/64" x 9 7/8"	K602C	E-Z Steer	I100S & I120 Non-Driving Garlock Bushing Axle Models
S-A484	FAK 5456 140KK100 1668412C92	2 3/64" x 10 1/8"	K603C	E-Z Steer	I140S Non-Driving Axle Models
S-13563	1668412C91	2 3/64" x 10 1/8"	K603	Bronze R201427	I140S Axle Models
S-17327	2505495C91	1 63/64" x 11 7/32"	—	R201475 E-Z Steer	MFS18 w/ E-Z Steer Bushings
S-A482	FAK5454	1 23/64" x 7 31/32"	K592C	E-Z Steer	I60 & 80 Double Drawkey 6/8k Lbs. Front Axle Models 3800 School Bus Series

All parts supplied are S&S Truck Parts Inc./NEWSTAR. Use of other manufacturer's names, part numbers, or trademarks are solely used for informational/identification purposes.

SUSPENSION

## NUTS



S-9415



S-17567



S-5753



S-A973



S-4688

NEWSTAR #:	REPLACES #:	DESCRIPTION:	APPLICATION:	DIMENSIONS:
S-5070	144425H	Nylon Suspension Locknut	—	7/8" - 14 UNF
S-2245	41419V	All Metal Wheel Nut	—	3/4" - 16 UNF
S-2889	41420V	All Metal Wheel Nut	—	3/4" - 16 UNF
S-4955	50325R1	All Metal Wheel Nut	—	2 1/16"
S-4961	54495R2	All Metal Wheel Nut	—	3/4" - 10 UNF
S-7665	83155H	All Metal Wheel Nut	—	1 1/8" - 16 UNF
S-7666	83156H	All Metal Wheel Nut	—	1 1/8" - 16 UNF
S-7622	144424H	Nylon Suspension	—	3/4" - 16 UNF
S-4700	388355C1	All Metal Axle	—	1 3/4" - 12
S-4737	414087C1	All Metal Suspension	—	1/2" - 20 UNF
S-4738	414089C1	All Metal Suspension	—	5/8" - 18 UNF
S-4740	416743C1	All Metal Suspension Grade C Flange Locking	—	3/4" - 16
S-5848	421913C1	Castellated Axle	—	1 3/4" - 12 UN
S-3929	440302C1	All Metal Axle	—	1 3/4" - 12
S-C106	591219C1	Nylon Transmission	—	1 1/4" - 18 THD
S-4740	1675448C1	All Metal Suspension	—	3/4" - 16 NF
S-9720	1696471C1	Nylon Axle	—	1 1/2" - 12 NPT
S-13453	1696474C1	Nylon Axle	—	1 3/4" - 12 UN
S-7622	2003027C1	Nylon Axle	—	3/4" - 16 NF
S-4740	2502028C1	All Metal Suspension	—	3/4" - 16 NF
S-9195	BX239357	All Metal Air	—	7/8" - 20
S-5848	ETN0083799	Castellated Axle	—	1 1/4" - 18
S-6603	FUL22254	Nylon Transmission	—	2" - 16
S-4688	36415H 53395H	Wheel Nut	—	2 1/2" - 12 OD: 3 1/4" Width: 31" 6 Point
S-17567	27293R1	RA472 Series Lock Nut	—	9/16" - 12 NF
S-16983	144422H	Lock Nut	—	9/16" - 18
S-A973	1685173C1	Lock Nut	—	M45
S-5753	586049C1	Magnetic Plug	—	3/4" -14 NPT
S-9415	1649492C1	Wheel Nut	—	M22 X 1.5 33mm x 31mm
S-A213	2000231C1	Lock Nut	4000 Series Medium Duty 5000 Series Severe Duty 2500 & 2600 Heavy Service Models	—

All parts supplied are S&S Truck Parts Inc./NEWSTAR. Use of other manufacturer's names, part numbers, or trademarks are solely used for informational/identification purposes.





## SPRING PINS & COMPONENTS

### COMPLEMENTARY COMPONENTS



NEWSTAR #:	REPLACES #:	DESCRIPTION:	LENGTH:	PRODUCT INFORMATION:
S-5779	507203C1	Front Bracket Spring Pin	7 3/8"	8100-8300 & 9100-9400 Series Conventionals 9600-9900 Series Cabovers
S-2634	688952R1	Front & Rear Spring Pin	7 3/8"	5000-5900 Models
S-5601	688951R1	Spring Pin Bushing	4"	—



NEWSTAR #:	REPLACES #:	DESCRIPTION:	LENGTH:	PRODUCT INFORMATION:
S-C302	1698113C1	Spring Eye Bushing	4"	4500-4900 Models RE300 & 3000-3900 School Bus Series 
S-19965	ZAK300577L	Spring Eye Bushing	4"	Hendrickson Split Bushing Design
S-19820	3515801C1	Spring Eye Bushing	4"	2000, 4000, 8000 & 9000 Series 3000, FE300 & Amtran School Bus Series 
S-5087	1648109C1 468703C2	Front Bracket Spring Pin	7"	1700-2500 Models (1989 & Before)
S-7579	1671766C1	Rear Bracket Spring Pin	5 35/64"	4500-4900, 9200-9400 Series Conventionals 9600-9800 Series Cabovers 3000-3900 & Amtran School Bus Series 
S-7580	1661976C3 3511254C1	Front Bracket Spring Pin	7"	4500-4900 & 8100-8300 Series 3400-3900 School Bus Series 
S-5088	1648110C1 468704C2	Rear Bracket Spring Pin	6 5/16"	1700-2500 Series Medium Duty (1989 & Before)
S-2409	206258R3	Main Rebound Spring Pin	5 1/2"	4100-4900 & 9100-9900 Series Conventionals 3000-3900, Amtran, CE & FE School Bus Series 

## TIE ROD ENDS

NEWSTAR #:	REPLACES #:	PRODUCT INFORMATION:
S-5056	FTR187L FLT187L NSSK187L	110362R92 NSS187L FD, FE & FG900 Axle Models
S-5057	FTR187R USK187R NSSK187R	NSS187R 110363R92 FD, FE & FG900 Axle Models
S-4767	FTR373R 450062C	1660272C92 FA71, 73, 74, 101, 103 & 104 Axle Models
S-4768	FTR373L FTR373LA	450063C 1660273C92 FA71, 73, 74, 101, 103 & 104 Axle Models



All parts supplied are S&S Truck Parts Inc./NEWSTAR. Use of other manufacturer's names, part numbers, or trademarks are solely used for informational/identification purposes.



## TIE ROD ENDS

NEWSTAR #:	REPLACES #:	PRODUCT INFORMATION:
<b>S-7459</b>	FTR411L NSSK411L NSS411L FTR411LA	1649637C USK411L 507835C91 447094C91 FA109, 118, 339, 342, 309, 127, 341, 340, 329, 139 & 337 Axle Models
<b>S-7460</b>	FTR411R 507836C91 447095C91 1649638C	FTR411RA NSSK411R NSS411R USK411R FA109, 118, 339, 342, 309, 127, 341, 340, 329, 139 & 337 Axle Models
<b>S-7358</b>	FTR423L	506661C91 Meritor FF921, 931, 932, 941, FA109, 139, 309, 329, 339 Axle Models
<b>S-7357</b>	FTR423R 507838C91 FTR423RA	1681456C91 506662C92 Meritor FF921, 931, 932, 941, FA109, 139, 309, 329, 339 Axle Models
<b>S-5048</b>	FTR431L	FH901 & FL901 Axle Models
<b>S-5049</b>	FTR431R FTR431RA NSS431R	NSK431R 969056R91 FH901 & FL901 Axle Models
<b>S-8634</b>	FTR2069R	FLT2069R FO90, 120 & D Axle Models
<b>S-8635</b>	FTR2070L	FLT2070L FO90, 120 & D Axle Models
<b>S-6659</b>	FTR2090L FLT209L FLT3033L	FTR3033L NSSK2090L NSS2090L FL931, 941 & FH901 Axle Models
<b>S-5988</b>	FTR2091R FTR3034R 442354C91 5066844C91 581063C91 FTR2202R FTR2204R	FTR2204RA 590584C91 FTR3034RA FTR3302R NSSK2091R NSS2091R FL931, 941 & FH901 Axle Models
<b>S-6659</b>	FTR3033L FLT2090L	FLT3033L FTR209L FL931, 941 & FH901 Axle Models
<b>S-E395</b>	FTR3476	FLT3476 E10001, 12001 & 13201 Axle Models
<b>S-E394</b>	FTR3477	FLT3477 E10001, 12001 & 13201 Axle Models
<b>S-A764</b>	FTR8224 FLT3204L	1668224C91 16, 051 & 805 Axle Models
<b>S-A765</b>	FTR8225 FLT3205R	1668225C91 16, 051 & 805 Axle Models
<b>S-D639</b>	FTR8407 FLT3217L	1668407C91 1405 Axle Models
<b>S-D640</b>	FTR8408 FLT3218R	1668408C91 1405 Axle Models
<b>S-B599</b>	FTR8409 FLT3219L	1668409C91 12, 051 & 405 Axle Models
<b>S-B600</b>	FTR8410 FLT3220R	1668410C91 12, 051 & 405
<b>S-F505</b>	1658946C91	S Series For Dropped I-Beam
<b>S-F506</b>	1658947C91	S Series For Dropped I-Beam
<b>S-12090</b>	263498C91 FLT235NL	FTR235NL FA68, 72 & 89
<b>S-12091</b>	263499C91 FLT235NR	FTR235NR FA68, 72 & 89



SUSPENSION



All parts supplied are S&S Truck Parts Inc./NEWSTAR. Use of other manufacturer's names, part numbers, or trademarks are solely used for informational/identification purposes.

## TORQUE RODS

NEWSTAR #:	REPLACES #:	PRODUCT INFORMATION:
S-E913	493920C3	Length: 18 1/8" (Center to Center)
	581271C1	
	3581271C91	



S-E913

NEWSTAR #:	REPLACES #:	PRODUCT INFORMATION:
S-14653	501565C2	3800 Models Length: 25 1/4" (Center to Center) 3000FE, IC & RE School Bus Series  3400, 3600 & 3900 School Bus Series (May 1997 & Before) 
	3580088C91	
	3548381C	
	3580088C1	



S-14653

NEWSTAR #:	REPLACES #:	PRODUCT INFORMATION:
S-E914	2504006C91	Length: 22" (Center to Center)



S-E914

## TORQUE ROD BUSHINGS



S-19962



S-17746







S-11965



S-3888



S-19963

NEWSTAR #:	REPLACES #:	PRODUCT INFORMATION:
S-17746	1693546C1	4500-4900 & 9200-9400 Series Conventional Cabovers 9600-9800 Series Cabovers 3000 School Bus Series (May 1997 & Before) 
S-11965	1693060C1	4500-4900 & 9200-9400 Series Conventional Cabovers 9600-9800 Cabovers 3000 School Bus Series (May 1997 & Before) Works w/ S-7580 
S-19962	1693061C1	3000 School Bus Series (May 1997 & Before)  Works w/ S-7580
S-19963	1693066C1	Hendrickson Applications Works w/ Pin Style Torque Rods 4500-4900 & 9200-9400 Series Conventional Cabovers 9600-9800 Series Cabovers 3400-3800 School Bus Series 
S-3888	322069C91	Cargostar Models w/ Hendrickson Suspensions

All parts supplied are S&S Truck Parts Inc./NEWSTAR. Use of other manufacturer's names, part numbers, or trademarks are solely used for informational/identification purposes.

## SHOCK ABSORBERS



S-D894



S-5421



S-11797

NEWSTAR #:	REPLACES #:	PRODUCT INFORMATION:
<b>S-D894</b>	1664788C2 2032533C1 2015556C1 AMS565107 3571711C1 3571712C1	4500-4900 Series Medium Duty 8000 Series Heavy Duty 9000 Series Premiums 14,000 lb. Suspension
<b>S-5421</b>	503610C2 AMS600103 AMS6886	9300-9800 Premium Conventional & Cabovers 10,800-14,600 lb. Suspension
<b>S-11797</b>	3514952C1 H60675003	4000 Series Medium Duty 5000 Series Severe Duty 9000 Series Premium Conventionals 14,000 lb. Suspension
<b>S-17728</b>	3586883C1	9200, 9400 & 9900 Premium Conventionals 12,000-18,000 lb. Suspension
<b>S-F385</b>	2018987C2 1675455C1 504553C91 AM565409 1690035C1	3000 School Bus Series  9800 Series Premium Cabovers 14,000 lb. Suspension

## SHACKLES





S-3137



S-A730





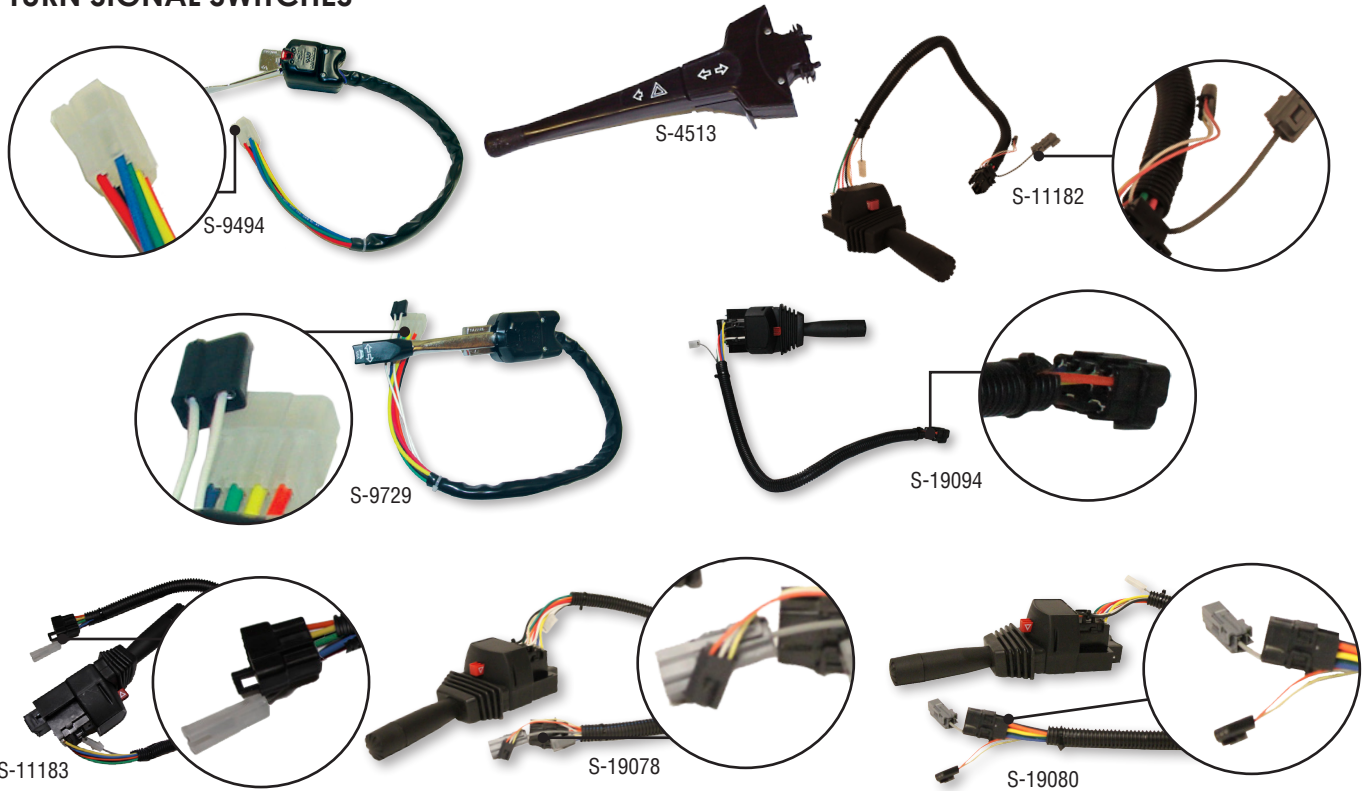

S-11752

NEWSTAR #:	REPLACES #:	DESCRIPTION:	PRODUCT INFORMATION:
<b>S-8733</b>	1654269C1	Shackle	8000 Series Dimensions: 5-3/4"
<b>S-A730</b>	1664223C1	Shackle Front Spring	3000 School Bus Series  4500-4900 Series Medium Duty Dimensions: 6"
<b>S-11752</b>	571960C1	Hanger Pad	3000 FE, IC, RE School Bus Series 
<b>S-3137</b>	346130C1	Shackle	CargoStar Series Cast Iron Design Dayton 4-Spring

## TURN SIGNAL SWITCHES



NEWSTAR #:	REPLACES #:	PRODUCT INFORMATION:
<b>S-4513</b>	471302C91	S Series Medium Duty School Bus 
<b>S-9494</b>	775863C93 1663595C91	S Series Medium & Heavy Duty Non-Canceling Switch
<b>S-9729</b>	1616317C91	4000 & 8000 Series
<b>S-11182</b>	3566936C91 TL963Y100 2002875C91	4000 Series Medium Duty School Bus  Works w/o Head Lamp Dimmer & Wiper Control
<b>S-11183</b>	3566941C91 TL962Y101 2034257C91	4000 Series Medium Duty School Bus  Works w/o Head Lamp Dimmer & Wiper Control Includes Hazard Control
<b>S-19094</b>	3566935C91	3400-3900 Models (May 1997 & Before) Medium Duty School Bus Series  Basic Switch w/ Hazard
<b>S-19078</b>	3566939C91	3400-3900 School Bus Series (May 1997 & Before)  4500-4900 Series Medium Duty Basic Switch w/ Hazard & Extended Harness
<b>S-19082</b>	3566945C91	4700 Series Medium Duty Switch w/ Hazard & Extended Harness
<b>S-19079</b>	3566942C91	4500-4900 Series Medium Duty Warning Hazard & Wiper/Washer Control
<b>S-19080</b>	3566943C91	4500-4900 Series Medium Duty Basic Switch w/ Hazard
<b>S-19081</b>	3566944C91	4500-4900 Series Medium Duty Switch w/ Hazard & Extended Harness

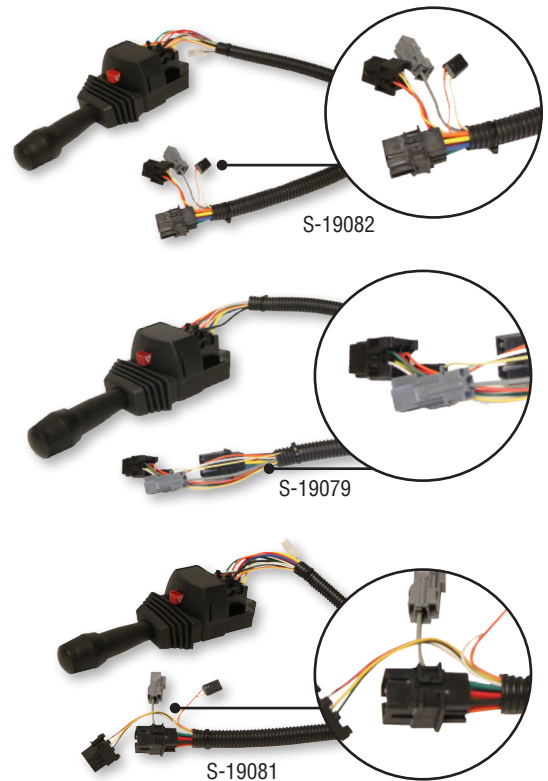

All parts supplied are S&S Truck Parts Inc./NEWSTAR. Use of other manufacturer's names, part numbers, or trademarks are solely used for informational/identification purposes.

## DIMMER SWITCHES

### COMPLEMENTARY COMPONENTS



**DIMMER SWITCH**  
S-4356

**KNOB**  
S-13970

NEWSTAR #:	REPLACES #:	DESCRIPTION:	PRODUCT INFORMATION:
S-15543	393442ASSY	Switch & Knob Assembly	4000 & Medium Duty S Series
<b>CONSISTS OF:</b>			
S-4356	393442C1	Dimmer Switch	4000 & Medium Duty S Series
S-13970	469859C1	Knob	

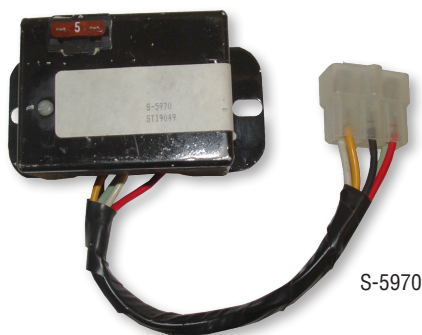

S-5970

NEWSTAR #:	REPLACES #:	DESCRIPTION:	PRODUCT INFORMATION:
S-5970	577295C1	Dimmer Switch	9370 & 9670 Models

## STOP LIGHT SWITCHES



S-5934

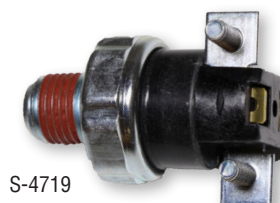

S-4719

NEWSTAR #:	REPLACES #:	TYPE:	DESCRIPTION:	SIZE:
S-4687	358560C1 2589993C	2 Terminal	Stop Light Switch	2 Prong - 1/4"
S-4719	505026C1 873706R91	2 Terminal	Sealed Stop Light Switch	1/4" NPT
S-9093	598860C1	2 Terminal	Sealed Stop Light Switch	1/4" NPT
S-A264	BX228600	2 Terminal	Replacement for Bendix SL-4 Style	1/4" NPT

All parts supplied are S&S Truck Parts Inc./NEWSTAR. Use of other manufacturer's names, part numbers, or trademarks are solely used for informational/identification purposes.



## IGNITION SWITCHES

NEWSTAR #:	REPLACES #:	PRODUCT INFORMATION:
<b>S-3600</b>	344688C91 429047C1 468438C91	Universal
<b>S-9348</b>	1652306C91 1652307C91	4000 & 8000 Series



## BACKUP, BRAKE & HEAD LAMP SWITCHES

NEWSTAR #:	REPLACES #:	DESCRIPTION:
<b>S-4739</b>	416372C1	Brake Switch Backup Lamp Switch
<b>S-2523</b>	434297C1	Heater Switch
<b>S-2938</b>	454925C1	Backup Lamp Switch
<b>S-2661</b>	509190C2	Toggle Switch
<b>S-9104</b>	1646970C1	Backup Lamp Switch
<b>S-9094</b>	1661234C3	Head Lamp Swicth
<b>S-A824</b>	1699216C91	Backup Lamp Switch

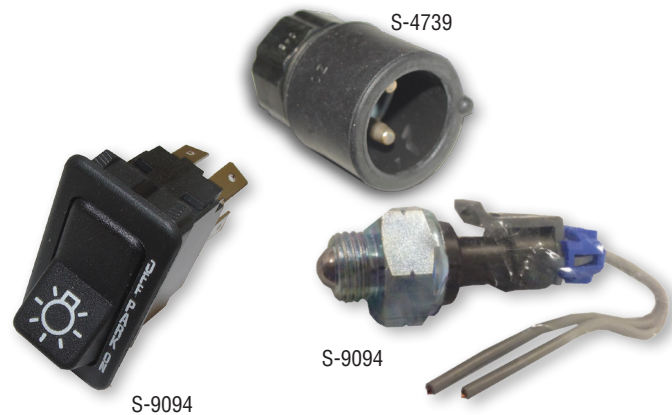

## LOW PRESSURE SWITCHES

NEWSTAR #:	REPLACES #:	TYPE:	DESCRIPTION:	SIZE:
<b>S-4817</b>	505027C1	1 Terminal	Sealed	1/4" NPT
<b>S-9127</b>	1658820C1	1 Terminal	Sealed	1/8" NPT
<b>S-A265</b>	BX228750	2 Terminal	Replacement for Bendix LP-3 Style	1/4" NPT
<b>S-A266</b>	BX279416	1 Terminal	Replacement for Bendix LP-3 Style	1/4" NPT

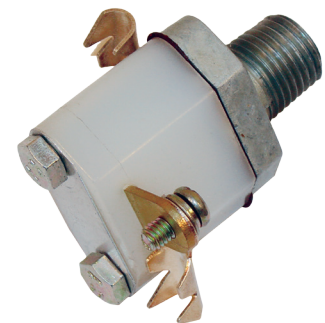

## BLOWER SWITCHES

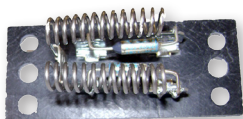

S-17953

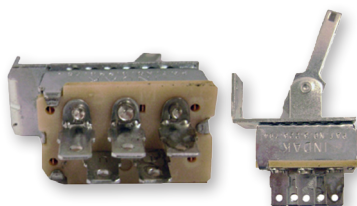

S-9712

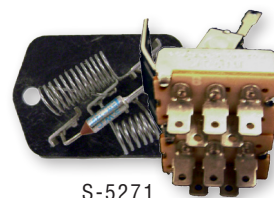



S-5271

NEWSTAR #:	REPLACES #:	DESCRIPTION:	PRODUCT INFORMATION:
S-9712	472253C1	Toggle Blower Switch	Universal 5 Terminal
S-17963	501087C3	Toggle Blower Switch	5000 Series 9200-9400 Conventional Models 9600-9800 Cabover Models Terminal
S-5271	506552C1	4 Speed Blower Resistor	9400 Series 4 Terminal
S-19400	1661420C1	Blower Switch	4000, 5000, 8000 & 9000 Series 3000 School Bus Series (May 1997 & Before) 
S-17953	1696836C1	Blower Resistor	2000, 4000 & 8000 Series 12V, W2 152C Fuse
S-17242	2503727C1 ZGG71400D	4 Speed Blower Resistor	5000 & 9000 Series 121C Fuse

SWITCHES

## CRUISE CONTROL SWITCHES

NEWSTAR #:	REPLACES #:	PRODUCT INFORMATION:
S-E178	1622366C91	2000 & 8000 Series 3000 School Bus Series (May 1997 & Before)  3800 School Bus Series (May 1997 & Up) 

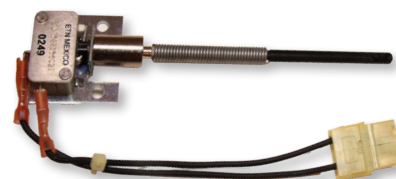

S-E178

## SOLENOID SWITCHES



S-D895



S-A649





S-E555

NEWSTAR #:	REPLACES #:	PRODUCT INFORMATION:
S-D895	286786C1	40 & 50 MT
S-A649	1693479C91 1618940C1	Prestolite Systems
S-E555	1115598	42 MT New No Core Charge

All parts supplied are S&S Truck Parts Inc./NEWSTAR. Use of other manufacturer's names, part numbers, or trademarks are solely used for informational/identification purposes.

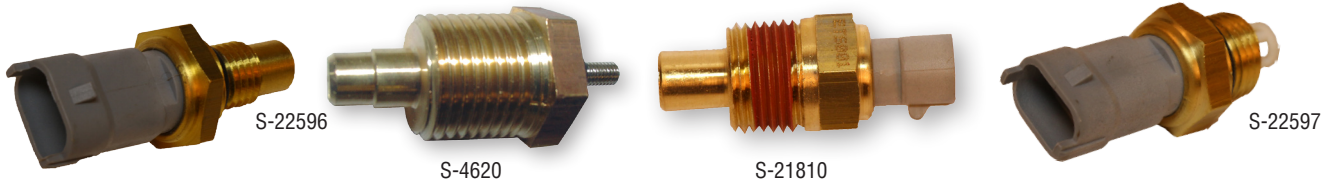
## OIL SENSORS & GAUGES



NEWSTAR #:	REPLACES #:	DESCRIPTION:	PRODUCT INFORMATION:
<b>S-2935</b>	143240R91 1513678C92	Oil Pressure Sender	Loadstar & Cargostar Models
<b>S-4620</b>	479758C1	Oil Sender Gauge	S Series Medium & Heavy Duty
<b>S-5018</b>	777700C91	Oil Sender	5000 Series 9200-9400 Conventional Models 9600-9800 Cabover Models
<b>S-21810</b>	1675751C1	Temperature Sender Gauge	3000, Amtran, FE & RE300 School Bus Series  4000 Series Medium Duty 5000 Series Severe Duty 9000 Series Premium Cabovers
<b>S-22596</b>	1836-537-C91	Oil Temperature Sensor	DT466 Engine Models 4100-4400 Series Medium Duty BE200, CE200, 300, FE600 & RE300 School Buses
<b>S-22597</b>	1836-539-C91	Manifold Air Sensor	DT466 Engine Models 4100 - 4400 Series Medium Duty BE200, CE200, 300, FE600 & RE300 School Bus Series

SWITCHES

## ADDITIONAL ELECTRICAL COMPONENTS



NEWSTAR # :	REPLACES #:	DESCRIPTION:	PRODUCT INFORMATION:
<b>S-5126</b>	277055C91	Horn Relay	1700-2500 Series Medium Duty (1989 & Before) 9600-9700 Cabover Models
<b>S-5129</b>	287116C91	Choke & Throttle Control	Loadstar & Cargostar Models
<b>S-4690</b>	361974C1	Escutcheon	V345 & V392 Gas Engine Models
<b>S-4751</b>	433178C1	Breaker, 30 Amp	1700-2500 Series Medium Duty (1989 & Before) 9600-9700 Cabover Models
<b>S-4945</b>	493068C1	Ignition Condenser	1700-2100 Series Medium Duty (1989 & Before)
<b>S-2214</b>	877313R92	Distributor Cap	V345 & 392 Engine Models
<b>S-9442</b>	1681254C1	Brake Relay	4500-4900 Series Medium Duty (1997 & Before)
<b>S-A604</b>	1688312C1	Warning Buzzer	3000-3900 & Amtran School Bus Series  4500-4900 Series Medium Duty 9200-9400 Models 9600-9800 Series Cabovers
<b>S-C379</b>	1688314C1	Control Module	8100-8300 & 3000 Series 3400, 3600, 3800, Amtran & FE School Bus Series  4500-4900 Series Medium Duty
<b>S-C380</b>	2026910C1	Horn & B-Up Alarm	3000, 3400, 3600, 3800, Amtran & FE School Bus Series  4500-4900 Medium Duty & 8100-8300 Models

ADDITIONAL COMPONENTS

All parts supplied are S&S Truck Parts Inc./NEWSTAR. Use of other manufacturer's names, part numbers, or trademarks are solely used for informational/identification purposes.

## AIR & BRAKE

## AIR & BRAKE

## AIR & BRAKE

NEWSTAR #:	REPLACES #:	PAGE #:
S-13761	65273	7
S-13761	65457	7
S-13761	65461	7
S-13753	65465	8
S-13753	65466	8
S-13761	65601	7
S-17326	65683	8
S-17326	65684	8
S-22528	103818	11
S-13761	107979	7
S-13761	107980	7
S-13761	107981	7
S-13761	108193	7
S-13761	108194	7
S-13761	108236	7
S-13761	108237	7
S-13761	108730	7
S-13761	108987	7
S-13761	109087	7
S-13761	109088	7
S-13761	109110	7
S-13761	109111	7
S-13761	109136	7
S-13753	109138	8
S-13753	109139	8
S-13753	109141	8
S-13753	109142	8
S-13761	109253	7
S-13753	109319	8
S-13753	109321	8
S-13753	109322	8
S-13761	109522	7
S-13761	109551	7
S-13761	109552	7
S-13761	109626	7
S-17326	109816	8
S-17326	109824	8
S-17326	109860	8
S-17326	109863	8
S-17326	109864	8
S-13761	109882	7
S-C446	286880	12
S-22527	287053	11
S-17326	800256	8
S-13753	800291	8
S-17326	800292	8
S-13761	800468	7
S-13761	800469	7
S-13753	800725	8
S-13761	3093850	7
S-21431	3101137	9
S-21431	3103413	9
S-21431	3104216	9
S-21431	3681902	9
S-21431	3681904	9
S-21435	3944524	9
S-21435	3944525	9
S-21435	3944526	9
S-21435	3966522	9
S-21431	4952758	9
S-13761	5000559	7
S-17326	5001522	8
S-17326	5001523	8
S-17326	5001533	8
S-17326	5001534	8
S-17326	5001773	8

NEWSTAR #:	REPLACES #:	PAGE #:
S-17326	5001774	8
S-17326	5001788	8
S-17326	5001789	8
S-17326	5002032	8
S-17326	5002033	8
S-13753	5002082	8
S-17326	5002652	8
S-17326	5002713	8
S-13753	5002826	8
S-13753	5002983	8
S-17326	5002984	8
S-17326	5003228	8
S-17326	5003229	8
S-17326	5003230	8
S-13753	5003231	8
S-13753	5003232	8
S-17326	5003234	8
S-17326	5003235	8
S-17326	5003236	8
S-13761	5003762	7
S-13761	5004612	7
S-13761	5004613	7
S-13761	5005412	7
S-13761	5005413	7
S-17326	5005419	8
S-13753	5005421	8
S-13753	5005422	8
S-17326	5005478	8
S-13753	5005491	8
S-13753	5005492	8
S-13753	5005496	8
S-13753	5005790	8
S-13761	5006716	7
S-13753	5007468	8
S-13753	5007469	8
S-13753	5007471	8
S-13753	5007471	8
S-13753	5008609	8
S-13761	5010279	7
S-13761	8166665	7
S-13761	12546827	7
S-13761	15977688	7
S-13761	15978946	7
S-13761	85102174	7
S-21431	9111535100	9
S-21435	9111535300	9
S-E278	BX5004338	11
S-8328	ZZKN32011	13
S-A323	1-487-434-901	10
S-A323	1-85127-004	10
S-13753	102-9551	8
S-13753	102-9553	8
S-13761	104-3823	7
S-13761	106-7851	7
S-13761	106-7852	7
S-13761	106-9089	7
S-13761	109-2996	7
S-17326	118-2798	8
S-17326	118-2806	8
S-13761	122-1713	7
S-13761	125-9562	7
S-17326	131-6679	8
S-17326	131-6680	8
S-17326	132-9813	8
S-17326	132-9814	8
S-17326	133-7032	8

NEWSTAR #:	REPLACES #:	PAGE #:
S-13753	139-9009	8
S-17326	143-9185	8
S-13753	143-9186	8
S-16988	1605095C91	12
S-13761	164-7557	7
S-13761	164-7558	7
S-17326	164-7564	8
S-13753	164-7566	8
S-13753	164-7567	8
S-13295	1646750C1	16
S-B360	1657081C91	18
S-A782	1658443C91	14
S-A917	1669311C91	15
S-A917	1669312C91	15
S-13753	167-1288	8
S-13761	1694005C92	7
S-B360	1695989C91	18
S-13761	1696864C92	7
S-13761	2003252C94	7
S-13761	2003253C94	7
S-B360	2033863C9	18
S-16933	2041137C91	12
S-17326	215-8055	8
S-3502	232040R91	17
S-9046	232049R11	17
S-3145	233009R1	17
S-3886	233010R11	17
S-10131	2501838C91	15
S-13998	2501841C91	15
S-21128	2509252C92	15
S-10131	2509254C91	15
S-E585	254468C1	14
S-E585	254468C1	15
S-E585	254468C1	15
S-10131	2593419C91	15
S-11177	2596609C1	16
S-E743	2596610C1	16
S-13295	2596611C1	16
S-13761	2991783C91	7
S-21431	3104216R	9
S-21431	3104216RX	9
S-5285	330-3009	18
S-20000	340-4195	18
S-B359	340-4975	18
S-B360	343-4009	18
S-B361	343-4013	18
S-B358	343-4024	18
S-B362	343-4075	18
S-B363	343-4095	18
S-B364	343-4249	18
S-11177	3531661C2	16
S-E743	3531662C1	16
S-13295	3531663C2	16
S-B365	359-5990	18
S-E781	359-5995	18
S-5285	388249C	18
S-20000	388249C1	18
S-A173	388912C91	17
S-C120	388914C1	17
S-A323	432-410-020-2	10
S-A323	432-420-220-2	10
S-20738	432-421-009-0	10
S-13761	4P-0596	7
S-13761	4P-2419	7
S-13761	4P-3596	7
S-13761	4P-5435	7

All parts supplied are S&S Truck Parts Inc./NEWSTAR. Use of other manufacturer's names, part numbers, or trademarks are solely used for informational/identification purposes.



## AIR & BRAKE

NEWSTAR #:	REPLACES #:	PAGE #:
S-E585	571250C1	14
S-E585	571250C1	15
S-E585	571250C1	15
S-A917	582024C91	15
S-4252	582028C93	15
S-21233	590684C91	17
S-9985	597577C92	17
S-13761	61-1670	7
S-13753	61-3909	8
S-4252	990952C93	15
S-E738	990953C93	14
S-D418	990956C91	14
S-13753	9Y-6320	8
S-9046	A-3736-K-375	17
S-3886	A-3787-N-14	17
S-C120	A-3787-Q-17	17
S-A173	A2-3722-G-501	17
S-3502	A33722E421	17
S-A473	BW 103981	10
S-A473	BW 104358	10
S-11844	BW 109493	10
S-16988	BX065157	12
S-4922	BX065212	13
S-11452	BX065212	13
S-F345	BX065225	10
S-12093	BX065626	11
S-A474	BX107794	10
S-A474	BX107796	10
S-E854	BX109495	12
S-E855	BX109496	12
S-D810	BX109569	11
S-E278	BX109570	11
S-C680	BX109578	12
S-E277	BX109579	12
S-F345	BX109685	10
S-D810	BX109686	11
S-E278	BX109695	11
S-E858	BX109869	18
S-E858	BX109871	18
S-18629	BX109995	11
S-4922	BX229859	13
S-11452	BX229859	13
S-8328	BX229860	13
S-9977	BX267051	7
S-9977	BX267098	7
S-9977	BX267100	7
S-6106	BX275491	7
S-11201	BX275747	12
S-4771	BX286171	12
S-C446	BX286880	12
S-4922	BX288251	13
S-11452	BX288251	13
S-9749	BX289714	13
S-E858	BX298948	18
S-D810	BX5004341	11
S-E278	BX5004381	11
S-A323	BX5008414	10
S-A917	BX55245	15
S-A782	BX55250	14
S-A917	BX55314	15
S-10131	BX55850	15
S-16929	BX800257	12
S-E859	BX800350	13
S-12093	BX800404	11
S-D810	BX800405	11
S-16988	BX800516	12

## AIR & BRAKE

NEWSTAR #:	REPLACES #:	PAGE #:
S-16933	BX800573	12
S-22905	BX801549	11
S-22906	BX801550	11
S-22897	BX801551	11
S-22907	BX801552	11
S-22902	BX801553	11
S-21233	BX802078	16
S-23223	BX802082	16
S-E585	BX94010	14
S-E585	BX94010	15
S-E585	BX94010	15
S-D418	BXH5635	14
S-17760	BXK022105	11
S-21233	BXK070796	16
S-13998	BXMKD786	15
S-21431	ECU9111535100X	9
S-21435	ECU9111535300X	9
S-E738	FPD225HD	14
S-13761	OR-3391	7
S-17326	OR-3845	8
S-17326	OR-4740	8
S-17326	OR-8253	8
S-17326	OR-8340	8
S-17326	OR-8341	8
S-13753	OR-8442	8
S-21431	R9559111535100X	9
S-21435	R9559111535300X	9
S-20738	S432-413-024-0	10
S-20738	S432-413-024-7	10
S-20738	S432-421-048-0	10
S-20738	S432-421-048-7	10
S-11201	SN4017A	12
S-22909	TDAR955336	11
S-13998	ZJCMKD786	15
S-11528	ZZKN-20611	12
S-11529	ZZKN-20615	12
S-6106	ZZKN18530	7

## CAB & BODY

NEWSTAR #:	REPLACES #:	PAGE #:
S-22276	640	32
S-22286	1301	35
S-21761	446883001	28
S-22277	647-SL	32
S-7021	108991R92	37
S-2171	121406R92	37
S-7434	121684R92	37
S-7435	121762R92	37
S-7027	127573R91	37
S-2860	127574R91	37
S-8530	1649776C1	28
S-4730	165519R91	34
S-18449	1657747C1	24
S-18448	1657748C1	24
S-2634	166166R91	34
S-19975	1661763C1	25
S-19976	1661764C1	25
S-7021	1662198C91	37
S-7691	1669309C2	35
S-21242	1675762C2	22
S-7434	1676278C91	37
S-17329	1677433C2	27
S-17330	1677434C2	27
S-17330	1677434C2	27

## CAB & BODY

NEWSTAR #:	REPLACES #:	PAGE #:
S-18290	1677435C2	27
S-9409	1686704C91	27
S-9410	1686705C91	27
S-A644	1686721C91	25
S-14004	1696499C	28
S-A287	1699929C91	20
S-18888	1699930C92	21
S-21302	2010717C1	19
S-18193	2023778C1	19
S-15593	2032580C91	35
S-17348	2040848C91	31
S-9671	208959R91	37
S-7024	213882C91	37
S-7024	213882R91	37
S-1802	219193R91	37
S-5116	244283R1	35
S-22411	2504705C1	28
S-21414	2505366C91	25
S-21415	2505369C91	25
S-21412	2505370C1	26
S-21413	2505371C1	26
S-7026	252577C91	37
S-3204	286655C4	35
S-23056	3501482C1	22
S-18988	3502239C2	23
S-21408	3502928C91	26
S-21411	3502929C91	26
S-18201	3518981C5	24
S-18202	3518982C5	24
S-18192	3521968C91	19
S-18194	3521969C91	19
S-17570	3523179C91	34
S-17571	3523180C91	34
S-21201	3527221C1	28
S-18197	3537837C	20
S-21821	3544924C1	21
S-21953	3549259C2	27
S-E627	3550925C	27
S-E627	3550931C91	27
S-18662	3551015C99	22
S-20631	3551734C2	21
S-18196	3551824C	20
S-18195	3551825C	20
S-11605	3558776C1	21
S-22728	3561965C1	25
S-22729	3561966C1	25
S-18199	3566716C2	24
S-18200	3566717C2	24
S-18203	3566927C91	22
S-19899	3574387C94	25
S-19900	3574388C94	25
S-21122	3588532C2	22
S-22794	3596015C95	26
S-22795	3596016C95	26
S-23258	3610930C	23
S-23002	3610935C	23
S-23843	3610939C	23
S-22214	3720617C3	24
S-22213	3720618C3	24
S-22310	3805331C99	24
S-22309	3805332C99	24
S-17570	3903524C91	34
S-4730	411948C91	34
S-2634	411949C91	34
S-19899	4020383C91	25
S-19900	4020384C91	25

All parts supplied are S&S Truck Parts Inc./NEWSTAR. Use of other manufacturer's names, part numbers, or trademarks are solely used for informational/identification purposes.

## CAB & BODY

NEWSTAR #:	REPLACES #:	PAGE #:
S-2627	422910C91	37
S-7026	447797C91	37
S-2627	459395C91	37
S-2983	472697C1	21
S-4921	472698C1	21
S-3200	475196C1	28
S-13951	477257C94	26
S-13952	477258C94	26
S-3061	491668C92	22
S-7630	498003C2	26
S-7631	498004C2	26
S-8043	499523C1	20
S-A287	500269ASSY	20
S-3136	500269C1	20
S-5588	500270C1	20
S-5589	500271C1	20
S-9041	500273C1	20
S-A514	500274C1	20
S-17331	508010C91	31
S-A968	576746C91	31
S-21313	598574C	22
S-2171	645573R91	37
S-22282	646-SL	32
S-22284	646B-SL	32
S-22283	646S-SL	32
S-22278	647S-SL	32
S-22280	648-SL	32
S-22279	648B-SL	32
S-22281	648S-SL	32
S-22675	649-SL	32
S-22674	649B-SL	32
S-22676	649S-SL	32
S-C459	682506R91	35
S-22285	742-S	33
S-7025	751762C91	37
S-7029	913774R91	37
S-7022	974180R93	37
S-22677	ACX40200	33
S-22358	AM0420SSC	23
S-23235	AM0421SSC	23
S-22382	FLT1900KIT	33
S-22678	MW1273BK	33
S-22679	MW1285BK	33
S-23593	MW971	33
S-7434	ZAD-11516	37
S-7435	ZAD-11577	37
S-1802	ZAD286600	37
S-7021	ZKC115	37
S-1802	ZKC1206I	37
S-7022	ZKC124	37
S-2171	ZKC153Q	37
S-7024	ZKC155Q	37
S-2860	ZKC160Q	37
S-7025	ZKC165	37
S-7026	ZKC170	37
S-7027	ZKC178Q	37
S-7029	ZKC188	37
S-7434	ZKC279Q	37
S-7435	ZKC280Q	37
S-2627	ZKC281	37
S-7658	ZKC297	37

## DRIVELINE

NEWSTAR #:	REPLACES #:	PAGE #:
S-D689	21589	39
S-7032	165888291	38
S-7021	108991R92	37
S-2171	121406R92	37
S-7434	121684R92	37
S-7435	121762R92	37
S-7027	127573R91	37
S-2860	127574R91	37
S-1720	136512HB	38
S-6116	140604R92	38
S-6918	150635R92	38
S-7798	1650879C91	38
S-D756	1658128C91	39
S-B613	1658833C91	39
S-A955	1658834C91	39
S-A293	1658835C91	39
S-7033	1658880C91	38
S-7031	1658881C91	38
S-B614	1662181C91	39
S-B615	1662182C91	39
S-7021	1662198C91	37
S-7935	1662709C91	40
S-7934	1662710C91	40
S-1980	1662711C91	40
S-D458	1662712C91	40
S-D460	1662713C91	40
S-D459	1662722C91	40
S-7926	1662725C91	40
S-B608	1662835C91	39
S-B609	1662836C91	39
S-B612	1662883C91	39
S-B333	1669550C91	40
S-7934	1676270C91	40
S-1980	1676271C91	40
S-7020	1676273C91	40
S-7434	1676278C91	37
S-7926	1676305C91	40
S-14117	1681117C91	39
S-D756	1685128C91	39
S-7798	1696914C91	38
S-7033	1696915C91	38
S-7032	1696916C91	38
S-7031	1696917C91	38
S-D757	170-70-28X	39
S-B608	2-70-18X	39
S-B609	2-70-28X	39
S-15366	2-94-58X	39
S-9671	208959R91	37
S-E715	212214X	39
S-7024	213882C91	37
S-7024	213882R91	37
S-1802	219193R91	37
S-D758	250-70-28X	39
S-D757	2500674C91	39
S-D758	2500675C91	39
S-E358	2500678C91	39
S-E359	2500680C91	39
S-C475	2502647C91	38
S-14117	2506391C91	39
S-E715	2507286C91	39
S-7026	252577C91	37
S-18847	2591048C91	40
S-1980	2591050C91	40
S-7020	2591051C91	40
S-B333	2591053C91	40
S-1980	2593349C1	40

## DRIVELINE

NEWSTAR #:	REPLACES #:	PAGE #:
S-7935	283067C93	40
S-1980	283069C93	40
S-7926	283071C93	40
S-1980	291870C91	40
S-B612	3-70-28X	39
S-B613	3-70-38X	39
S-B614	3-94-18X	39
S-B615	3-94-28X	39
S-7020	315442C91	40
S-7934	386418C91	40
S-2627	422910C91	37
S-7026	447797C91	37
S-2627	459395C91	37
S-C448	466505C91	40
S-7020	484002C91	40
S-9671	5-103X	37
S-7021	5-115X	37
S-9684	5-1204X	37
S-1802	5-1206X	37
S-2171	5-121X	37
S-7022	5-124X	37
S-B821	5-1300X	37
S-9846	5-1306X	37
S-A163	5-1309X	37
S-7023	5-134X	37
S-B118	5-137X	37
S-2171	5-153X	37
S-7024	5-155X	37
S-2860	5-160X	37
S-7025	5-165X	37
S-7026	5-170X	37
S-7027	5-178X	37
S-7029	5-188X	37
S-9683	5-213X	37
S-7030	5-260X	37
S-7434	5-279X	37
S-7435	5-280X	37
S-2627	5-281X	37
S-7658	5-297X	37
S-13953	5-308X	37
S-9347	5-3147X	37
S-6101	5-324X	37
S-7889	5-326X	37
S-C587	5-332X	38
S-9845	5-353X	38
S-6110	5-4002X	38
S-6099	5-407X	38
S-11832	5-4140X	38
S-7798	5-438X	38
S-7031	5-469X	38
S-13841	5-5031X	38
S-7032	5-510X	38
S-7033	5-515X	38
S-6113	5-5177X	38
S-6921	5-5800XX	38
S-6919	5-5801X	38
S-6920	5-5802X	38
S-6125	5-6000X	38
S-6109	5-6102X	38
S-6107	5-6106X	38
S-C472	5-674X	38
S-C473	5-675X	38
S-C474	5-676X	38
S-C475	5-677X	38
S-A955	5-70-28X	39
S-1720	5-7000X	38

All parts supplied are S&S Truck Parts Inc./NEWSTAR. Use of other manufacturer's names, part numbers, or trademarks are solely used for informational/identification purposes.

## DRIVELINE

NEWSTAR #:	REPLACES #:	PAGE #:
S-6118	5-7105X	38
S-6116	5-7202X	38
S-13211	5-785X	38
S-6126	5-8105X	38
S-6123	5-8200X	38
S-6124	5-8202X	38
S-6117	5-9001X	38
S-11158	5-9017X	38
S-6918	5-92X	38
S-6099	578379C91	38
S-A293	6.5-70-18X	39
S-2171	645573R91	37
S-6125	65351R93	38
S-6123	69557R93	38
S-7025	751762C91	37
S-D756	90-70-28X	39
S-7029	913774R91	37
S-7022	974180R93	37
S-B117	S-55-55-2	39
S-14117	SPL100-1X	39
S-E358	SPL170X	39
S-E359	SPL250X	39
S-E129	SPL90X	39
S-7434	ZAD-11516	37
S-7435	ZAD-11577	37
S-1802	ZAD286600	37
S-7021	ZKC115	37
S-1802	ZKC1206I	37
S-7022	ZKC124	37
S-2171	ZKC153Q	37
S-7024	ZKC155Q	37
S-2860	ZKC160Q	37
S-7025	ZKC165	37
S-7026	ZKC170	37
S-7027	ZKC178Q	37
S-7029	ZKC188	37
S-1980	ZKC2101211X	40
S-7020	ZKC2103911X	40
S-E319	ZKC2104331X	40
S-7926	ZKC2106611X	40
S-B240	ZKC2108661X	40
S-7434	ZKC279Q	37
S-7435	ZKC280Q	37
S-2627	ZKC281	37
S-7658	ZKC297	37
S-6099	ZKC407Q	38
S-B240	ZKC408661X	40
S-C472	ZKC5674	38
S-C474	ZKC5676	38
S-6125	ZKC6100	38
S-C473	ZKC675	38
S-C475	ZKC677	38
S-1720	ZKC7000	38
S-6116	ZKC7202	38
S-13211	ZKC785	38
S-6123	ZKC8200	38
S-6918	ZKC92	38
S-7020	ZMB2103911X	40

## DRIVETRAIN

NEWSTAR #:	REPLACES #:	PAGE #:
S-5501	8677	46
S-5761	12815	46
S-5761	12815	47
S-13912	14311	47

## DRIVETRAIN

NEWSTAR #:	REPLACES #:	PAGE #:
S-4596	14750	46
S-9063	16980	46
S-9063	16980	47
S-4312	20550	46
S-4312	20550	47
S-A018	81504	46
S-7440	85533	46
S-7440	85533	47
S-B039	85535	46
S-B039	85535	47
S-23013	994346	47
S-11966	4301417	47
S-13948	4303362	47
S-A726	4303431	47
S-E330	4304815	47
S-16421	5566505	46
S-16421	5566505	47
S-18611	208925-25EE	45
S-E420	107935-E2EE	45
S-18600	108034-61EE	45
S-18598	108034-82EE	45
S-18599	108050-59EE	45
S-18602	108050-59EE	45
S-18594	108063-59	45
S-18595	108063-59EE	45
S-18601	108950-59EE	45
S-17180	1657064C91	47
S-15475	1677144C1	41
S-A608	1810855C93	42
S-10006	1818214C91	42
S-10005	1821915C93	42
S-21611	1830858C1	47
S-20630	2005406C1	42
S-21811	208925-20EE	45
S-18615	208925-51EE	45
S-18612	208925-70EE	45
S-18613	208925-82EE	45
S-18616	208925-82EE	45
S-18617	208925-91EE	45
S-18618	208925-94EE	45
S-22012	2591985C91	47
S-19996	300781C1	41
S-21695	476337C2	42
S-19914	483767C1	42
S-9208	572107C91	42
S-7440	697924R6	41
S-7660	697956R2	42
S-B038	69883R1	41
S-B039	797700C1	41
S-20128	C104100-1	43
S-20129	C104100-2	43
S-20130	C104200	43
S-8304	C107034-19	43
S-8305	C107034-32	43
S-8306	C107034-53	43
S-8305	C107034-54B	43
S-8308	C107035-22	43
S-8307	C107035-36	43
S-8310	C107035-53	43
S-E353	C107050-59	43
S-E352	C107063-59	43
S-8314	C107090-52	43
S-8318	C107091-52	43
S-E603	C107091-81	43
S-8297	C107113-5	43
S-8296	C107113-7	43

## DRIVETRAIN

NEWSTAR #:	REPLACES #:	PAGE #:
S-8299	C107137-5	43
S-8298	C107137-6	43
S-E430	C107137-8	43
S-8302	C107142-2	43
S-E599	C107237-16	43
S-C580	C107237-8	43
S-E600	C107342-11	43
S-E606	C107391-74	43
S-E416	C107391-93	43
S-8853	C107606-1	44
S-C372	C107620-1	44
S-E429	C107621-7	44
S-E433	C107683-16	43
S-E432	C107683-5	43
S-E434	C107684-6	43
S-8295	C107688-7	43
S-E419	C107935-51	43
S-D575	C108034-61	44
S-D574	C108050-59	44
S-E437	C108063-59	44
S-C310	C108391-74	44
S-18603	C108391-74EE	45
S-C307	C108391-77	44
S-18604	C108391-77EE	45
S-C308	C108391-78	44
S-18605	C108391-78EE	45
S-C309	C108391-81	44
S-18606	C108391-81EE	45
S-E440	C108391-82	44
S-18607	C108391-82EE	45
S-E441	C108391-93	44
S-18609	C108391-93EE	45
S-13309	C108925-10	44
S-18611	C108925-20EE	45
S-21811	C108925-20EE	45
S-18612	C108925-70EE	45
S-C311	C108925-82	44
S-18613	C108925-82EE	45
S-21740	C108935-15	45
S-18614	C108935-26EE	45
S-E442	C108935-51	44
S-18615	C108935-51EE	45
S-18616	C108935-82EE	45
S-C697	C108935-91	44
S-18617	C108935-91EE	45
S-E443	C108935-94	44
S-18618	C108935-94EE	45
S-21888	C108937-32EE	45
S-E439	C108950-59	44
S-C311	C208925-82	44
S-C697	C208925-91	44
S-E443	C208925-94	44
S-9971	FUL K-2468	46
S-15476	K-3600	47
S-E425	LP1047-134	44
S-E426	LP1067-144	44
S-E427	LP1072-134	44
S-7440	NSDS105C137	41
S-6519	S-1659	46
S-E911	S-2822	47

All parts supplied are S&S Truck Parts Inc./NEWSTAR. Use of other manufacturer's names, part numbers, or trademarks are solely used for informational/identification purposes.

## ENGINE

## ENGINE

## ENGINE

NEWSTAR #:	REPLACES #:	PAGE #:
S-19886	441187	52
S-19929	637606	53
S-19953	1001921	53
S-23033	1003671	48
S-19957	1030035	52
S-19953	1030055	53
S-23036	1102254	48
S-E225	1990379	65
S-16660	1990428	65
S-E226	1990483	65
S-23050	2869133	54
S-23050	2878071	54
S-23050	3683253	54
S-23050	3683435	54
S-14694	3803403	62
S-D893	3803605	62
S-20995	3804502	53
S-19612	4089910	62
S-23050	4952490	54
S-19957	9107001	52
S-16660	10461075	65
S-10134	19011176	65
S-E230	19020302	65
S-E232	19020306	65
S-15369	19020388	65
S-21575	110-555HD	65
S-21576	110-555P	65
S-23033	1102431AS	48
S-7664	11175C91	58
S-7625	130704R1	55
S-22009	1517672C91	57
S-22010	1616029C1	57
S-8997	1619114C5	55
S-19886	1646077C1	52
S-19953	1651980C1	53
S-19957	1659054C1	52
S-19957	1659055C1	52
S-18484	1660540C91	57
S-7890	1661919C5	55
S-D905	1664723C3	63
S-D906	1664726C2	63
S-20215	1664729C7	63
S-20818	1664730C7	63
S-17264	1668901C91	48
S-5222	1672105C91	54
S-16104	1673866C1	53
S-19953	1674003C1	53
S-9414	1674053C1	54
S-9440	1684364C7	64
S-19953	1685578C1	53
S-9084	1689785C91	58
S-9084	1692761C91	58
S-8327	1694880C91	64
S-9767	1694952C91	64
S-19957	1696920C1	52
S-19957	1696955C1	52
S-19957	1696956C1	52
S-19951	1696958C1	52
S-16536	1697273C1	48
S-20474	1697743C2	48
S-19952	1698844C1	53
S-19886	17V9701	52
S-5966	1804027C2	67
S-9715	1804211C2	66
S-7542	1804495C93	60
S-19402	1807563C1	59

NEWSTAR #:	REPLACES #:	PAGE #:
S-9261	1807917C1	66
S-8185	1809058C2	67
S-19405	1812348C1	67
S-21726	1813892C1	59
S-22083	1814376C1	66
S-E803	1815538C91	62
S-20069	1815904C2	54
S-B473	1817687C96	62
S-20517	1817867C93	59
S-9261	1819649C1	66
S-5331	1820953C4	67
S-21312	1822135C1	59
S-19947	1822652C92	67
S-19829	1822653C92	67
S-22013	1824400C1	54
S-18567	1824415C93	60
S-21018	1824946C1	60
S-21070	1825473C93	60
S-20656	1826703C1	59
S-22118	1830-256-C93	66
S-B473	1830606C93	62
S-21949	1830742C92	58
S-23394	1830844C93	66
S-13248	1831676C92	62
S-18777	1833564C92	58
S-17343	1841217C91	59
S-22760	1842-130-C3	66
S-22706	1842380C91	59
S-22011	1842624C91	58
S-21951	1842626C96	66
S-17036	1842664C92	62
S-22864	1845002C91	62
S-21300	1846296C91	55
S-23094	1876108C91	60
S-23396	1889905C91	66
S-19886	1E 3486	52
S-19886	1E3488G	52
S-19952	1E3594	53
S-19952	1E3595	53
S-19952	1E3595G	53
S-19951	1E3738	52
S-19952	1E4151	53
S-16538	2000985C91	48
S-3780	200106R1	63
S-19951	2002583C1	52
S-19952	2004399C1	53
S-19952	2005432C1	53
S-A638	2010529C91	64
S-9731	2012260C1	58
S-16104	2014134C2	53
S-13490	2018471C1	57
S-20705	2031661C1	57
S-20705	2033978C	57
S-C118	2039390C1	55
S-20465	2500917C91	49
S-14677	2501022C91	58
S-21954	2501107C1	59
S-16535	2502718C1	49
S-6031	2504714C1	52
S-20472	2504903C91	49
S-22642	2504905C92	49
S-20062	2505157C1	49
S-16537	2505159C91	50
S-19929	2508432C1	53
S-20737	2508454C91	50
S-21945	2508700C93	55

NEWSTAR #:	REPLACES #:	PAGE #:
S-14677	2509380C91	58
S-22643	2509895C2	50
S-16534	2585978C91	50
S-19929	2587235C1	53
S-22644	2591559C91	50
S-21742	2591600C91	53
S-21566	2591625C2	55
S-22645	2592331C91	51
S-23044	2593295C91	51
S-23044	2593294C91	51
S-23044	2593303C91	51
S-21742	2596587C91	53
S-14677	2602141C91	58
S-19855	2602935C91	55
S-23793	2604296C	57
S-21742	2596587C91	53
S-14677	2602141C91	58
S-19855	2602935C91	55
S-2888	286324C2	63
S-19886	3000154C1	52
S-4673	336079R91	61
S-4675	338614C1	54
S-21725	3519061C1	54
S-20473	3527216C91	51
S-20654	3532799C1	60
S-21946	3539918C1	65
S-10134	3540035C91	65
S-23256	3553803C2	57
S-21952	3557858C1	56
S-19039	3578833C3	55
S-5222	3586939C1	54
S-23049	376905-031	54
S-23050	376905-041	54
S-5328	379318C1	61
S-14699	38713RA	58
S-23049	4089380NX	54
S-19886	4401-3504	52
S-19848	464751C1	59
S-2729	470031C2	63
S-6034	475173C4	64
S-C396	475174C5	64
S-6034	475177C3	64
S-9438	476846C2	64
S-4799	477854C91	64
S-3777	479237C1	63
S-8327	488499C2	64
S-D629	493349C2	51
S-D630	493359C2	51
S-D631	493367C1	51
S-23050	4956008NX	54
S-9439	497840C96	64
S-21185	503401C2	52
S-3938	503579C1	63
S-6031	506017C1	52
S-7601	508999C2	64
S-7625	530874R1	55
S-4965	549558C91	57
S-4966	549559C91	57
S-4117	549841C91	64
S-D967	554318C1	57
S-4333	554319C1	57
S-3777	583955C1	63
S-8476	583978C91	56
S-7687	583979C91	56
S-4986	586531C3	55
S-19886	6-1131	52

All parts supplied are S&S Truck Parts Inc./NEWSTAR. Use of other manufacturer's names, part numbers, or trademarks are solely used for informational/identification purposes.

## ENGINE

NEWSTAR #:	REPLACES #:	PAGE #:
S-4293	685155C94	62
S-5331	691796C1	67
S-4293	735327C91	62
S-2731	753997C93	63
S-2595	80445R1	63
S-21575	8LHA2070VB	65
S-21576	8LHP2170P	65
SSAF1968M	AF1968M	61
SSAF25139M	AF25139M	61
S-22680	EC30PLA-R	56
S-B339	EC30PLS	56
S-C110	EC35PLA	56
S-22681	EC35PLA-R	56
S-22682	EC35PLS-R	56
S-4965	EC40EST	57
S-8476	EC40PLA	56
S-22683	EC40PLA-R	56
S-D424	EC40PLS	56
S-22684	EC40PLS-R	56
S-4966	EC50EST	57
S-7687	EC50PLA	56
S-22685	EC50PLA-R	56
S-A999	EC50PLS	56
S-22686	EC50PLS-R	56
SSFF5052	FF5052	61
S-8476	FLT40PLA	56
S-7687	FLT50PLA	56
S-4966	FLTA50AF	57
S-21358	FRE 1020-00001	53
S-A999	FRT50PLS	56
SSFS1000	FS1000	61
SSFS1212	FS1212	61
S-21372	FS19624	61
S-7664	L17446	58
SSLF3620	LF3620	61
SSLF3970	LF3970	61
SSLF689	LF689	61
SSLFP9000	LF9000	61
S-19886	NV8A	52
S-23036	VAB1050166	48
S-23036	VAB1102254	48
S-23033	VAB1102431	48
SSWF2071	WF2071	61
SSWF2072	WF2072	61
SSWF2074	WF2074	61
SSWF2077	WF2077	61
S-4293	WP181091	62
S-E803	WP181366	62
S-17036	WP181911	62
S-D967	XH89548K	57
S-A862	XH89549K	57
S-A862	XH89549K	57
S-7687	XH90358A	56
S-14513	ZBH994205	58
S-14030	ZBH994305	58
S-14676	ZBH994307	58
S-4965	ZF589527B	57
S-A999	ZF590358A	56
S-4966	ZFS89528B	57
S-7537	ZFS89533K	54
S-8476	ZFS90356A	56
S-13248	ZWP181693	62

## HVAC

NEWSTAR #:	REPLACES #:	PAGE #:
S-22385	151346	75
S-17946	526407	72
S-17943	530631	72
S-17959	651186	76
S-17936	748040	76
S-21390	1099014	68
S-17962	1099073	76
S-8584	1113002	68
S-17960	1299008	68
S-17944	1613007	75
S-21164	1613008	75
S-22385	1613011	75
S-20949	1713012	75
S-17939	1813008	76
S-17959	2013005	76
S-17943	3112001	72
S-17946	3112009	72
S-17936	3213003	76
S-19050	20501067	73
S-17950	1664769C92	74
S-21390	1669786C1	68
S-13667	1693117C1	70
S-9660	1699291C1	68
S-17238	1699947C1	69
S-17239	1699949C1	69
S-22385	1699950C1	75
S-17240	1699956C2	72
S-19500	18-01800	70
S-23110	2000655C2	71
S-23021	2009378C2	71
S-17241	2051794C93	74
S-17962	2227279C2	76
S-17948	2303279C1	68
S-17955	2502459C91	73
S-17945	2503207C1	74
S-F429	2503267C91	68
S-17952	2503783C91	74
S-17243	2506656C2	72
S-17961	2507482C92	71
S-17244	2508698C1	71
S-19297	2509451C91	73
S-23022	2585373C2	71
S-17958	2586812C91	71
S-19501	2589563C1	68
S-19501	2589648C1	68
S-21563	2591621C93	71
S-22386	2591836C91	71
S-17942	2598644C1	69
S-21164	2602544C1	75
S-23708	2606229C91	76
S-19248	3527631C91	73
S-17936	3529263C1	76
S-20950	3542575C2	74
S-21164	3542576C2	75
S-17246	3542577C2	70
S-21613	3542578C2	77
S-17941	3542606C1	74
S-17947	3542611C2	69
S-20957	3543881C1	74
S-20956	3543882C1	74
S-17940	3546241C1	77
S-19049	3547917C1	73
S-17939	3548044C1	76
S-17243	3548705C1	72
S-17959	3562102C1	76
S-17247	3582435C1	73

## HVAC

NEWSTAR #:	REPLACES #:	PAGE #:
S-20949	3599598C1	75
S-20524	3622764C3	76
S-19047	3628699C1	73
S-18994	3660853C2	74
S-22384	3666273C1	70
S-17944	3670132C1	75
S-20544	3670134C1	70
S-21198	3674285C1	69
S-17248	367972C92	75
S-17954	369512C92	75
S-20617	3839141C1	72
S-17960	4140-01-199-4589	68
S-4889	450907C1	75
S-8584	465502C1	68
S-17951	481813C1	72
S-7670	498144C1	72
S-17246	526333C2	70
S-17957	581691C1	77
S-23316	6102498C92	70
S-17960	756-360-C	68
S-17960	783966C93	68
S-19049	ABPN83-304314	73
S-20524	BOA 80-908-00-329	76
S-18708	DF12V	68
S-19047	LE1600	73
S-18824	RD-5-6868-0P	74
S-19050	SKI 4493	73
S-17962	ZGG701076	76
S-19050	ZGG705256	73
S-17943	ZGG720010	72
S-17946	ZGG720014	72

## POWER STEERING

NEWSTAR #:	REPLACES #:	PAGE #:
S-A526	1516829C91	79
S-B216	1614025C91	78
S-B210	1618607C91	79
S-B215	1644377C91	78
S-B215	1647567C91	78
S-7982	1648256C91	82
S-7985	1648322C91	82
S-D837	1651779C91	82
S-B215	1651836C91	78
S-7983	1651917C91	82
S-B216	1654717C91	78
S-B163	1654771C91	79
S-B216	1655606C91	78
S-B216	1655607C91	78
S-D484	1663204C91	78
S-E036	1663631C1	82
S-E036	1663631C1	83
S-17692	1663632C91	82
S-B216	1664376C91	78
S-B216	1665551C91	78
S-B215	1665552C91	78
S-B216	1666272C91	78
S-D484	1667497C91	78
S-E445	1668428C1	83
S-E445	1668428C91	82
S-D654	1668438C91	81
S-7627	1671216C93	81
S-B216	1671589C91	78
S-B216	1671876C91	78
S-9502	1675138C91	81
S-B215	1675898C91	78
S-B215	1677288C91	78

All parts supplied are S&S Truck Parts Inc./NEWSTAR. Use of other manufacturer's names, part numbers, or trademarks are solely used for informational/identification purposes.



## POWER STEERING

NEWSTAR #:	REPLACES #:	PAGE #:
S-5890	1681047C91	78
S-A711	1681048C91	79
S-B164	1681049C91	79
S-17041	1682625C91	78
S-D484	1682626C91	78
S-B216	1684290C91	78
S-D694	1685190C91	82
S-11556	1685676C91	82
S-D484	1686653C91	78
S-11558	1691583C91	82
S-7986	1691691C91	82
S-7198	1692999C91	81
S-7985	1693937C91	82
S-D837	1694395C91	82
S-11557	1696908C91	82
S-19406	1829802C1	83
S-17552	2005337C91	78
S-16201	2502008C91	82
S-D421	2502009C92	82
S-B066	2502017C91	81
S-9501	2505258C91	81
S-20704	2507061C1	83
S-9504	2508032C91	81
S-11556	2585853C91	82
S-19203	2585854C91	82
S-11558	2585855C91	82
S-19311	2585858C91	82
S-17692	2585860C91	82
S-11558	2586316C91	82
S-18827	2586319C91	82
S-19204	2589611C91	82
S-19204	2589611C91	82
S-E036	2590468C1	82
S-E036	2590468C1	83
S-21202	2591854C91	82
S-D421	2592441C91	82
S-16201	2592442C91	82
S-19203	2592443C91	82
S-18828	2592444C91	82
S-7984	3243261C91	82
S-D484	3504849C91	78
S-D484	3504850C91	78
S-17552	3514596C91	78
S-17552	3525624C91	78
S-5370	406280C1	82
S-A525	422479C91	80
S-7988	434031C91	80
S-8000	435673C1	81
S-7943	435854C91	81
S-7943	435854C91	83
S-7942	438758C1	82
S-4912	467537C91	80
S-4033	472925C91	81
S-4412	472933C91	81
S-7995	482350C91	80
S-8933	487320C91	81
S-8021	487339C91	81
S-8022	487340C1	81
S-4935	487344C91	81
S-4935	487344C91	83
S-5897	488787C91	79
S-7997	493133C91	80
S-4336	493141C91	80
S-4950	493143C91	80
S-7979	505657C92	80

## POWER STEERING

NEWSTAR #:	REPLACES #:	PAGE #:
S-4376	507809C91	80
S-4957	507810C91	80
S-A526	541508C91	79
S-B210	541510C91	79
S-A711	582135C92	79
S-4590	582463C91	81
S-B166	583808C91	79
S-4591	583823C91	81
S-B209	585930C91	79
S-7989	590727C91	80
S-7990	594210C91	81
S-B164	595055C91	79
S-B215	596246C92	78

## SENSORS

NEWSTAR #:	REPLACES #:	PAGE #:
S-20817	1669290C91	86
S-9443	1672537C1	85
S-20557	1807329C92	84
S-21317	1807369C2	86
S-23519	1812818C2	84
S-21161	1825899C93	86
S-20445	1828345C91	86
S-21205	1830669C92	84
S-20023	1831646C1	85
S-20620	1835985C92	86
S-22453	1839415C91	86
S-20290	1845428C92	86
S-20814	1840078C1	86
S-20710	1840903C91	85
S-20290	1845428C92	86
S-22413	1846481C92	86
S-20815	1850352C2	86
S-21364	1850353C2	86
S-22764	1875784C93	86
S-21161	1876735C91	86
S-19596	1885812C91	86
S-20813	1889995C91	86
S-9443	2012557C1	85
S-19847	2012557C1	85
S-5115	241120R91	85
S-20975	2602142C1	85
S-17314	3505300C1	85
S-21950	3519350C1	85
S-20305	3529673C1	84
S-20306	3529674C1	84
S-21838	3529675C1	84
S-21839	3529676C1	84
S-21840	3529677C1	84
S-20307	3529678C1	84
S-21994	3571998C1	85
S-19847	3607384C1	85
S-5971	447186C1	85
S-7606	505457C1	85

## SUSPENSION

NEWSTAR #:	REPLACES #:	PAGE #:
S-6485	806355	90
S-6486	806356	90
S-23613	971443	88
S-6485	1008431	90
S-5421	AMS6886	95
S-5223	101KK109	90

## SUSPENSION

NEWSTAR #:	REPLACES #:	PAGE #:
S-5223	101KK110	90
S-A483	120KK100	90
S-A484	140KK100	90
S-16983	144422H	91
S-7622	144424H	91
S-5070	144425H	91
S-A414	1514626C1	88
S-5087	1648109C1	92
S-5088	1648110C1	92
S-5223	1648204C91	90
S-9415	1649492C1	91
S-7459	1649637C	93
S-7460	1649638C	93
S-8733	1654269C1	95
S-4988	1658934C91	90
S-F505	1658946C91	93
S-F506	1658947C91	93
S-9304	1660271C91	90
S-9304	1660271C92	90
S-A719	1661437C92	88
S-7580	1661976C3	92
S-A730	1664223C1	95
S-D894	1664788C2	95
S-A764	1668224C91	93
S-A765	1668225C91	93
S-D639	1668407C91	93
S-D640	1668408C91	93
S-B599	1668409C91	93
S-B600	1668410C91	93
S-A483	1668411C92	90
S-13563	1668412C91	90
S-A484	1668412C92	90
S-7579	1671766C1	92
S-4740	1675448C1	91
S-F385	1675455C1	95
S-7357	1681456C91	93
S-A973	1685173C1	91
S-22467	1685174C1	87
S-F385	1690035C1	95
S-11965	1693060C1	94
S-19962	1693061C1	94
S-19963	1693066C1	94
S-17746	1693546C1	94
S-9720	1696471C1	91
S-13453	1696474C1	91
S-C302	1698113C1	92
S-22468	1R12-303	87
S-22471	1R12-432	87
S-22470	1R12-538	87
S-22469	1R12-603	87
S-22467	1R14-039	87
S-A213	2000231C1	91
S-7622	2003027C1	91
S-D894	2015556C1	95
S-F385	2018987C2	95
S-D894	2032533C1	95
S-2409	206258R3	92
S-4740	2502028C1	91
S-E914	2504006C91	94
S-17327	2505495C91	90
S-23612	2515-723-C	88
S-12090	263498C91	93
S-12091	263499C91	93
S-17567	27293R1	91
S-6946	301-SQ-44	89
S-6943	303138C92	89

All parts supplied are S&S Truck Parts Inc./NEWSTAR. Use of other manufacturer's names, part numbers, or trademarks are solely used for informational/identification purposes.

## SUSPENSION

NEWSTAR #:	REPLACES #:	PAGE #:
S-6947	303139C91	89
S-6946	303140C92	89
S-5134	309KK102	89
S-3888	322069C91	94
S-4949	337KK100	89
S-4988	343KK103	90
S-7801	343KK105	89
S-3137	346130C1	95
S-7580	3511254C1	92
S-11797	3514952C1	95
S-19820	3515801C1	92
S-14653	3548381C	94
S-D894	3571711C1	95
S-D894	3571712C1	95
S-14653	3580088C1	94
S-14653	3580088C91	94
S-E913	3581271C91	94
S-17728	3586883C1	95
S-4688	36415H	91
S-4700	388355C1	91
S-4707	400745C	88
S-4433	414051C1	87
S-4434	414052C1	87
S-4435	414053C1	87
S-4436	414054C1	87
S-4437	414055C1	87
S-4438	414056C1	87
S-4505	414076C1	87
S-4733	414077C1	87
S-4734	414078C1	87
S-4735	414079C1	87
S-4736	414080C1	87
S-5861	414081C1	87
S-5862	414082C1	87
S-4442	414084C1	87
S-13807	414085C1	87
S-9022	414086C1	87
S-4737	414087C1	91
S-4738	414089C1	91
S-2245	41419V	91
S-2889	41420V	91
S-C635	416734C1	87
S-7604	416736C1	87
S-14718	416739C1	87
S-14109	416740C1	87
S-4740	416743C1	91
S-5848	421913C1	91
S-8420	438286C1	87
S-3929	440302C1	91
S-5988	442354C91	93
S-7459	447094C91	93
S-7460	447095C91	93
S-4767	450062C	92
S-6950	452344C91	89
S-3072	465916C1	88
S-19488	465919C1	88
S-5087	468703C2	92
S-5088	468704C2	92
S-5223	473695C91	90
S-6949	474520C91	89
S-4949	493095C91	89
S-E913	493920C3	94
S-14653	501565C2	94
S-4955	50325R1	91
S-5421	503610C2	95
S-F385	504553C91	95

## SUSPENSION

NEWSTAR #:	REPLACES #:	PAGE #:
S-7358	506661C91	93
S-7357	506662C92	93
S-5988	5066844C91	93
S-5779	507203C1	92
S-7459	507835C91	93
S-7460	507836C91	93
S-7357	507838C91	93
S-4688	53395H	91
S-4961	54495R2	91
S-11752	571960C1	95
S-5988	581063C91	93
S-E913	581271C1	94
S-5753	586049C1	91
S-5134	586806C91	89
S-7801	588808C91	89
S-5988	590584C91	93
S-C106	591219C1	91
S-6949	597258C91	89
S-8529	597258C91	90
S-C618	661867C91	88
S-5601	688951R1	92
S-2634	688952R1	92
S-8371	806355B	90
S-D562	823078B	90
S-7665	83155H	91
S-7666	83156H	91
S-5049	969056R91	93
S-F385	AM565409	95
S-D894	AMS565107	95
S-5421	AMS600103	95
S-9195	BX239357	91
S-D562	ETN038342	90
S-23612	ETN0815326	88
S-6485	ETN806355	90
S-5848	ETNO083799	91
S-4949	FAK 4500	89
S-5134	FAK 4516	89
S-7801	FAK 4517	89
S-6942	FAK 4538	89
S-6943	FAK 4539	89
S-6944	FAK 4540	89
S-6945	FAK 4541	89
S-6946	FAK 4542	89
S-6947	FAK 4544	89
S-6943	FAK 4550	89
S-6947	FAK 4551	89
S-6950	FAK 4553	89
S-6949	FAK 4558	89
S-6950	FAK 4559	89
S-6963	FAK 4560	89
S-6964	FAK 4564	89
S-6965	FAK 4566	90
S-8513	FAK 4567	90
S-8529	FAK 4568	90
S-6946	FAK 4571	89
S-6485	FAK 4572	90
S-6486	FAK 4573	90
S-9304	FAK 4582	90
S-8371	FAK 4583	90
S-A811	FAK 4601	90
S-D562	FAK 4610	90
S-5223	FAK 5444	90
S-4949	FAK 5447	89
S-4949	FAK 5448	89
S-5134	FAK 5451	89
S-5223	FAK 5452	90

## SUSPENSION

NEWSTAR #:	REPLACES #:	PAGE #:
S-4988	FAK 5453	90
S-A483	FAK 5455	90
S-A484	FAK 5456	90
S-5223	FAK4519	90
S-8678	FAK4570	90
S-A482	FAK5454	90
S-A719	FDL1214A	88
S-C618	FDL1215	88
S-C618	FDL1215A	88
S-4707	FDL970	88
S-4707	FDL970A	88
S-A828	FDL979	88
S-A828	FDL979A	88
S-5056	FLT187L	92
S-8634	FLT2069R	93
S-8635	FLT2070L	93
S-6659	FLT2090L	93
S-6659	FLT209L	93
S-12090	FLT235NL	93
S-12091	FLT235NR	93
S-6659	FLT3033L	93
S-6659	FLT3033L	93
S-A764	FLT3204L	93
S-A765	FLT3205R	93
S-D639	FLT3217L	93
S-D640	FLT3218R	93
S-B599	FLT3219L	93
S-B600	FLT3220R	93
S-E395	FLT3476	93
S-E394	FLT3477	93
S-5056	FTR187L	92
S-5057	FTR187R	92
S-8634	FTR2069R	93
S-8635	FTR2070L	93
S-6659	FTR2090L	93
S-5988	FTR2091R	93
S-6659	FTR209L	93
S-5988	FTR2202R	93
S-5988	FTR2204R	93
S-5988	FTR2204RA	93
S-12090	FTR235NL	93
S-12091	FTR235NR	93
S-6659	FTR3033L	93
S-6659	FTR3033L	93
S-5988	FTR3034R	93
S-5988	FTR3034RA	93
S-5988	FTR3302R	93
S-E395	FTR3476	93
S-E394	FTR3477	93
S-4768	FTR373L	92
S-4768	FTR373LA	92
S-4767	FTR373R	92
S-7459	FTR411L	93
S-7459	FTR411LA	93
S-7460	FTR411R	93
S-7460	FTR411RA	93
S-7358	FTR423L	93
S-7357	FTR423R	93
S-7357	FTR423RA	93
S-5048	FTR431L	93
S-5049	FTR431R	93
S-5049	FTR431RA	93
S-A764	FTR8224	93
S-A765	FTR8225	93
S-D639	FTR8407	93
S-D640	FTR8408	93

All parts supplied are S&S Truck Parts Inc./NEWSTAR. Use of other manufacturer's names, part numbers, or trademarks are solely used for informational/identification purposes.

## SUSPENSION

NEWSTAR #:	REPLACES #:	PAGE #:
S-B599	FTR8409	93
S-B600	FTR8410	93
S-6603	FUL22254	91
S-11797	H60675003	95
S-5049	NSK431R	93
S-6659	NSS2090L	93
S-5988	NSS2091R	93
S-7459	NSS411L	93
S-7460	NSS411R	93
S-5049	NSS431R	93
S-5056	NSSK187L	92
S-5057	NSSK187R	92
S-6659	NSSK2090L	93
S-5988	NSSK2091R	93
S-7459	NSSK411L	93
S-7460	NSSK411R	93
S-8678	TDAR201315	90
S-5057	USK187R	92
S-7459	USK411L	93
S-7460	USK411R	93
S-19965	ZAK300577L	92

## SWITCHES

NEWSTAR #:	REPLACES #:	PAGE #:
S-3600	468438C91	98
S-13970	469859C1	97
S-4513	471302C91	96
S-9712	472253C1	99
S-4620	479758C1	100
S-17963	501087C3	99
S-4719	505026C1	97
S-4817	505027C1	98
S-5271	506552C11	99
S-2661	509190C2	98
S-5970	577295C1	97
S-9093	598860C1	97
S-9494	775863C93	96
S-5018	777700C91	100
S-4719	873706R91	97
S-A264	BX228600	97
S-A265	BX228750	98
S-A266	BX279416	98
S-11183	TL962Y101	96
S-11182	TL963Y100	96
S-17242	ZGG71400D	99

## SWITCHES

NEWSTAR #:	REPLACES #:	PAGE #:
S-E555	1115598	99
S-2935	143240R91	100
S-2935	1513678C92	100
S-9729	1616317C91	96
S-A649	1618940C1	99
S-E178	1622366C91	99
S-9104	1646970C1	98
S-9348	1652306C91	98
S-9348	1652307C91	98
S-9127	1658820C1	98
S-9094	1661234C3	98
S-19400	1661420C1	99
S-9494	1663595C91	96
S-21810	1675751C1	100
S-A649	1693479C91	99
S-17953	1696836C1	99
S-A824	1699216C91	98
S-22596	1836-537-C91	100
S-22597	1836-539-C91	100
S-11182	2002875C91	96
S-11183	2034257C91	96
S-17242	2503727C1	99
S-4687	2589993C	97
S-D895	286786C1	99
S-3600	344688C91	98
S-19094	3566935C91	96
S-11182	3566936C91	96
S-19078	3566939C91	96
S-11183	3566941C91	96
S-19079	3566942C91	96
S-19080	3566943C91	96
S-19081	3566944C91	96
S-19082	3566945C91	96
S-4687	358560C1	97
S-15543	393442ASSY	97
S-4356	393442C1	97
S-4739	416372C1	98
S-3600	429047C1	98
S-2523	434297C1	98
S-2938	454925C1	98

## ADDITIONAL COMPONENTS

NEWSTAR #:	REPLACES #:	PAGE #:
S-9442	1681254C1	101
S-A604	1688312C1	101
S-C379	1688314C1	101
S-C380	2026910C1	101
S-9620	2040568C91	101
S-20435	2506796C1	101
S-5126	277055C91	101
S-5129	287116C91	101
S-4690	361974C1	101
S-4751	433178C1	101
S-4945	493068C1	101
S-2214	877313R92	101

All parts supplied are S&S Truck Parts Inc./NEWSTAR. Use of other manufacturer's names, part numbers, or trademarks are solely used for informational/identification purposes.

### **S&S WARRANTY**

All Replacement Components covered in this catalog are warranted for one (1) year / 100,000 miles from installation, or 18 months after purchase from S&S Truck Parts, Inc., whichever comes first. We warrant all new parts against defective material or workmanship when such parts are used in appropriate applications. We will NOT extend this warranty to parts where failure or damage was caused by misapplication, accident, or abuse.

Unless otherwise stated, authorization from your salesperson is required to initiate any return for warranty. If our examination shows the parts to be defective, we will replace such parts free of charge. This warranty extends solely to replacement of defective parts; we disclaim liability for labor and/or special or consequential damages of any nature.

If it is necessary to return any parts under this warranty, the buyer agrees to wait for settlement of his claim before any deductions are made in payment to S&S. Any expenses incurred w/out the consent of S&S will be disallowed.



*Genuine*  
**NEWSTAR™**



*Genuine*  
**NEWSTAR™**

S&S Truck Parts, Inc., the parent company of Newstar, supplies parts and components for medium and heavy duty applications. Exceeding customers' expectations, products are vigorously tested in house by engineers and skilled technicians in an unsurpassed quality control laboratory. Superior customer service and support set S&S apart from the rest. Industry leading fill rate assures you get the parts you need, when you need them.

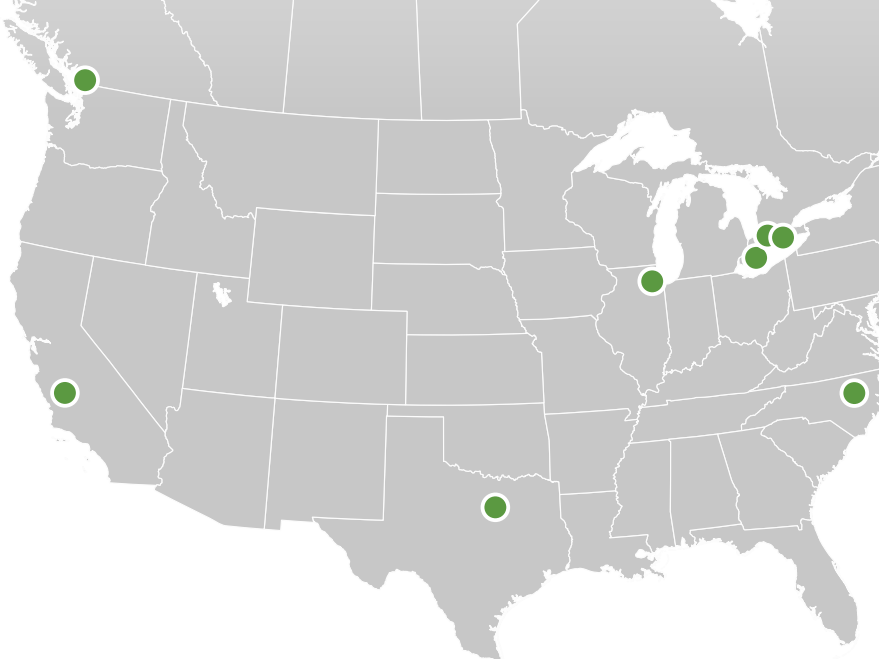

### UNITED STATES

#### Corporate Headquarters

600 W. Irving Park Rd.  
Schaumburg, Illinois 60193  
Order Desk: 844.446.7388  
Toll Free: 800.621.1553  
Fax: 847.584.3000  
Toll Free Fax: 800.621.1558  
Mexico Toll Free: 001-800-727-8373

5320 Departure Dr.  
Raleigh, North Carolina 27616  
Toll Free: 800.334.7058  
Local Fax: 919.872.2836

5200 Ontario Mills Pkwy, Suite 100  
Ontario, California 91764  
Toll Free: 888.621.1553  
Local Fax: 909.481.8555

1401 Valley View Ln, Suite 135  
Irving, Texas 75061  
Toll Free: 855.621.1553  
Local Fax: 972-986-9333

### CANADA

6460 Kestral Rd,  
Mississauga, Ontario L5T 1Z7  
Local Phone: 905.564.7100  
Toll Free: 800.363.4148  
Local Fax: 905.564.3485

19272-96th Ave., Unit 15  
Surrey, British Columbia V4N 4C1  
Local Phone: 604.882.2577  
Toll Free: 800.665.4327  
Local Fax: 604.882.3898

176 Creditstone Rd., Unit 10  
Concord, Ontario L4K 4H7  
Local Phone: 905.761.1399  
Toll Free: 800.363.4148  
Local Fax: 905.761.0698

5318 Finch Ave East, Unit 1-4  
Scarborough, Ontario M1S 5G2  
Local Phone: 416.412.7555  
Local Fax: 416.412.7580



For more information, contact our Customer Service Order Desk  
Toll Free: 844.446.7388 or email: [orderdesk@sandstruck.com](mailto:orderdesk@sandstruck.com)